

POLE (AM) system



POLE (AM)

Using pipe connection concept pole creates vertical, horizontal, mesh, irregular, flexible, creative style to meet all kinds of requirement.

POLE (AM)

POLE TRACK

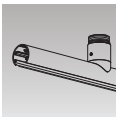

POT

TT application track

P.115

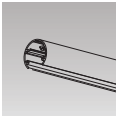

POT

ITI application track

P.115

POLE MODULES

	Series name	Module consumption	Lumen	
	POLE-L	2W 6W 12W	115 (lm) 344 (lm) 616 (lm)	P.124
	POLE-L-S	2W 6W 12W	128 (lm) 372 (lm) 737 (lm)	P.125
	POLE-S	6.4W	626 (lm)	P.126
	POLE-S	2.9W	50-70 (lm)	P.126
	POLE-K	11W	1000 (lm)	P.127
	POLE-C	6.4W	626 (lm)	P.128
	POLE-KC	22W	2000 (lm)	P.129

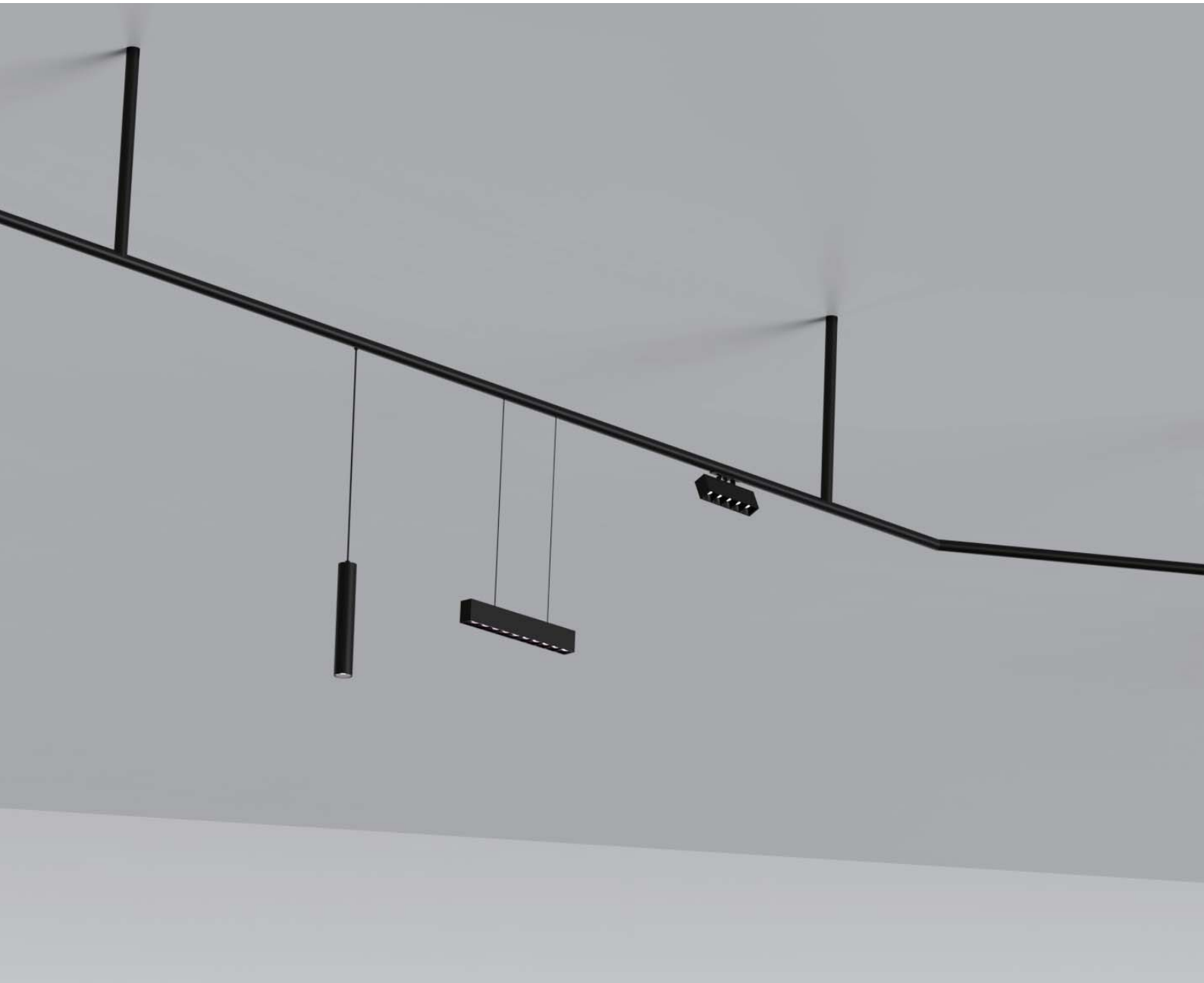

POLE modules

- LED module can be installed easily with variety of style to choose from.
- Pendant module can be used on desktop, countertop
- Spot module can be used on focal lighting.
- Linear module can be used as general lighting.

Pendant lights

POLE-C
6.4W



POLE-KC
22W

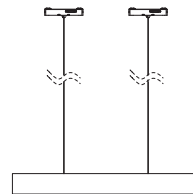



Spot lights

POLE-S

6.4W



2.2W



POLE-K

11W

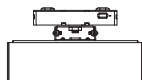

Strip lights

POLE-L 100mm 2W / 300mm 6W / 600mm 12W



POLE-L-S 100mm 2W / 300mm 6W / 600mm 12W



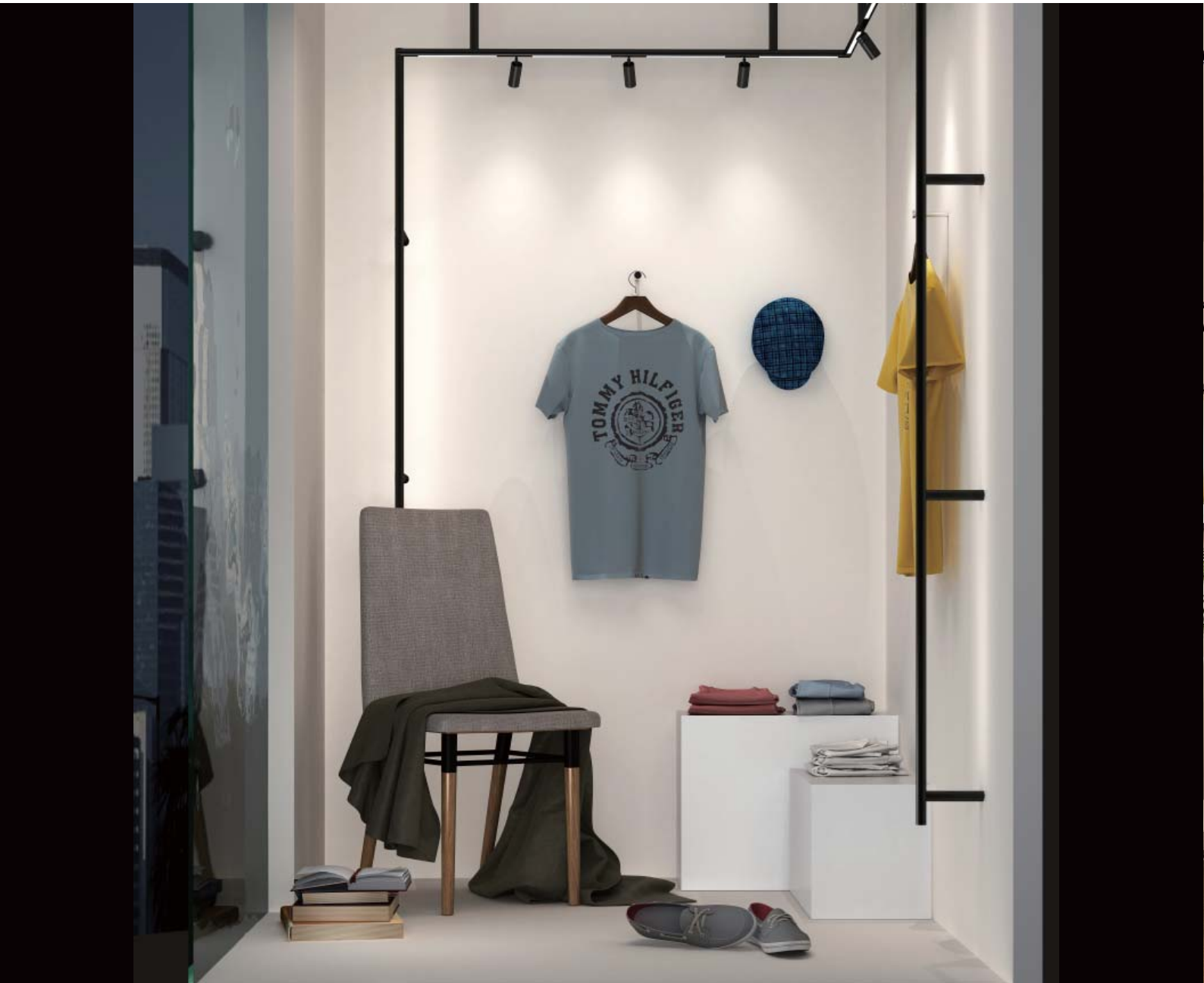

POLE application

Suitable for open space, combining with nordic leisure industrial style furniture,
Use different LED module to light up individual area for unique lighting effect.
LED module is designed to be click on installation.



POLE track connecting system

TT connection illustration

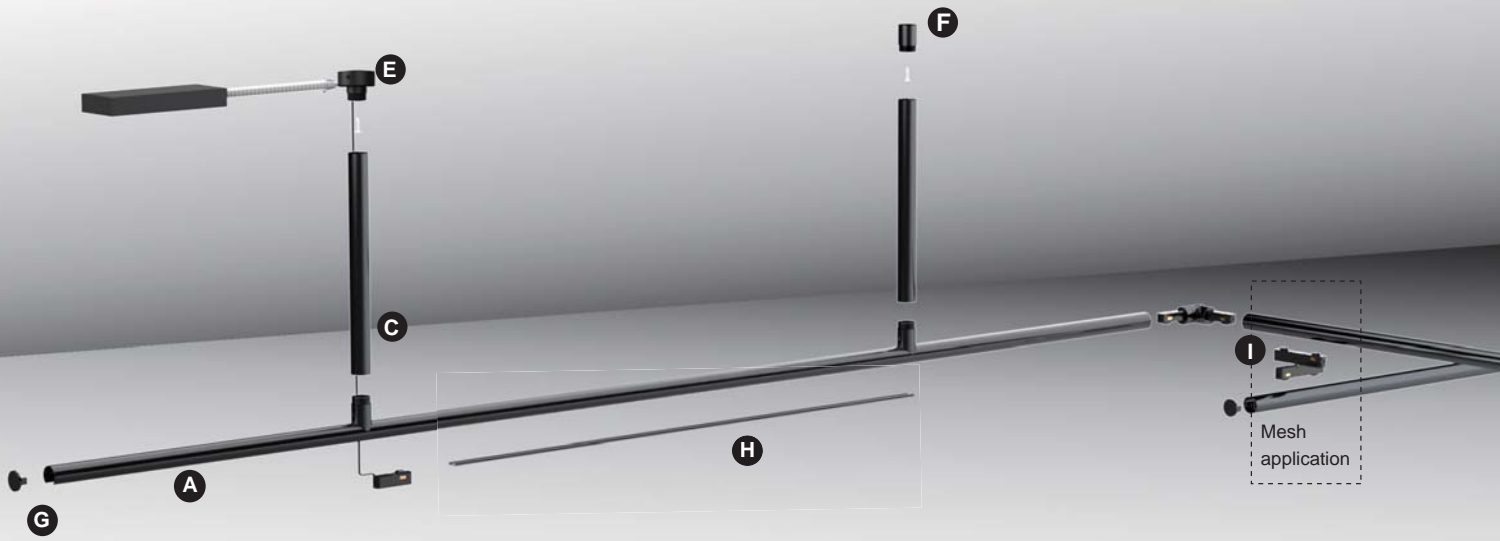

ITI connection illustration

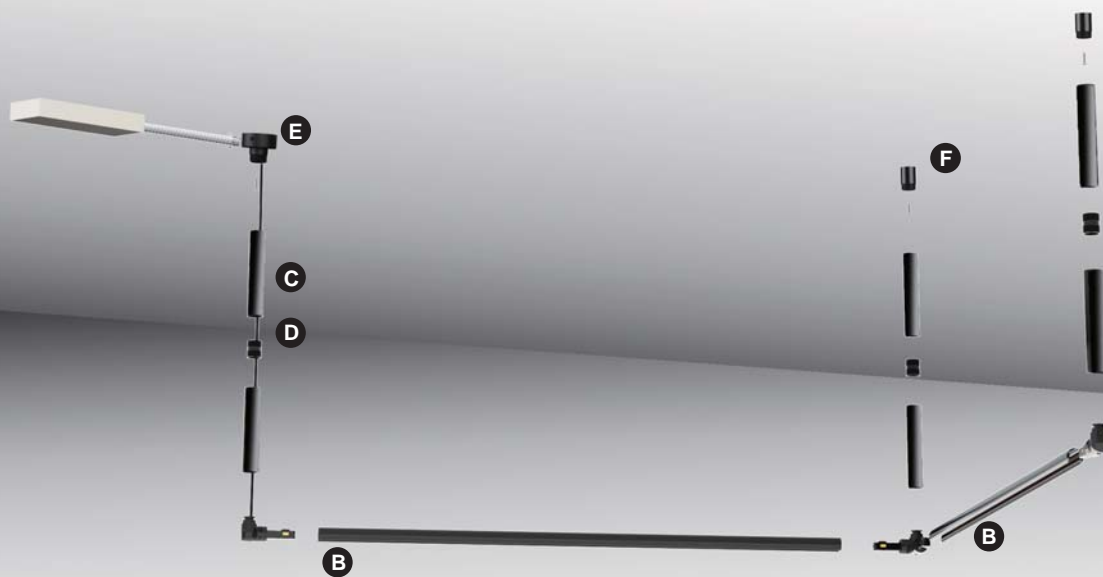

Accessories specifications

Track

A

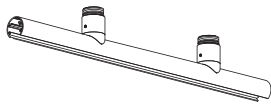

TT application track

POT-03-72
Length : 71.97"(1828mm)
POT-03-36
Length : 35.98"(914mm)

B

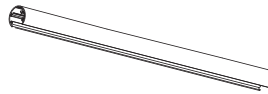

ITI application track

POT-04-36
Length : 35.98"(914mm)
POT-04-12
Length : 11.97"(304mm)

Fixed parts

C



Fixed tube

POI-01-36
Length : 35.98"(914mm)
POI-01-24
Length : 23.98"(609mm)
POI-01-12
Length : 11.97"(304mm)

D



Connecting tube

POI-02

E



Fixed base with power feed

POI-03

F



Fixed base

POI-04

G



End cap

POC-06

H

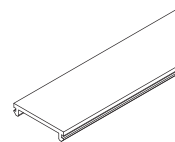

Blank cover

POE-01-72
Length : 71.97"(1828mm)

I

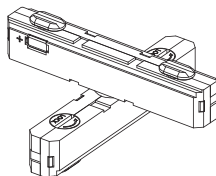

Mesh connector

POC-05

POLE loop connecting system

- 1. Max wattage linkable per loop for 24VDC is 150W.
- 2. Max length of track linkable per loop is 10M , and the max cable length between driver and power in is 2M.
- 3. Dimming modules are compatible to PWM dimming driver only.
- 4. To use drivers not on recommended list , it require compatibility test before installation.

TT connection illustration

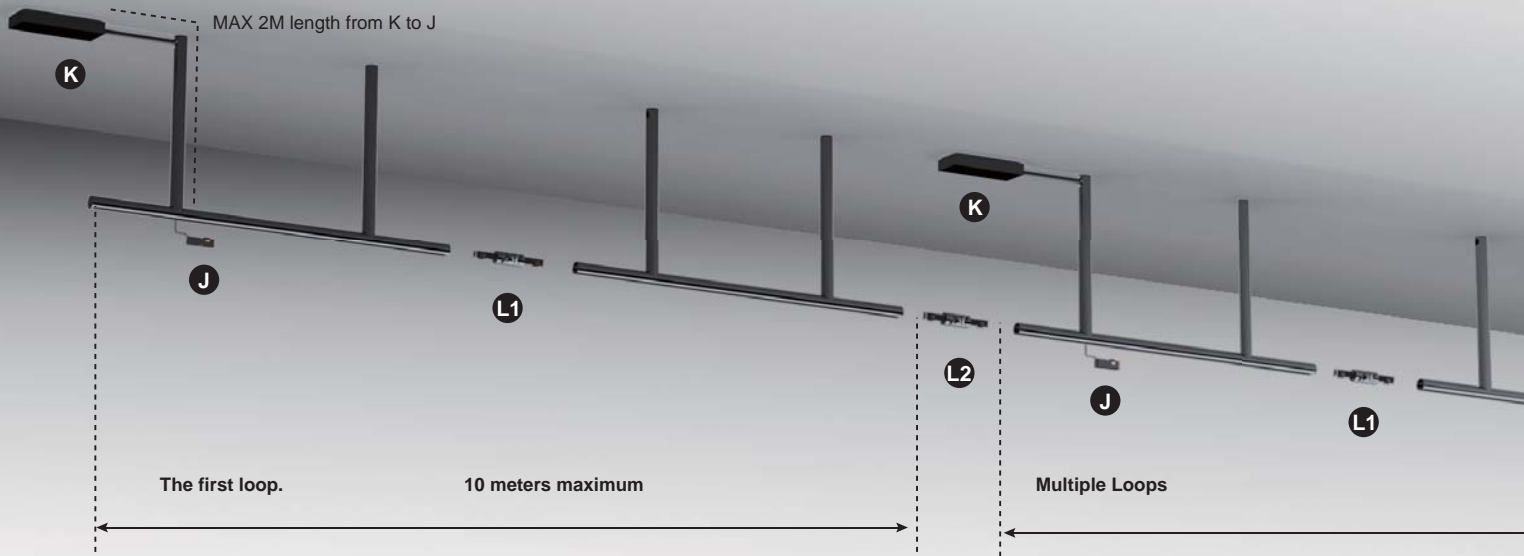

ITI connection illustration

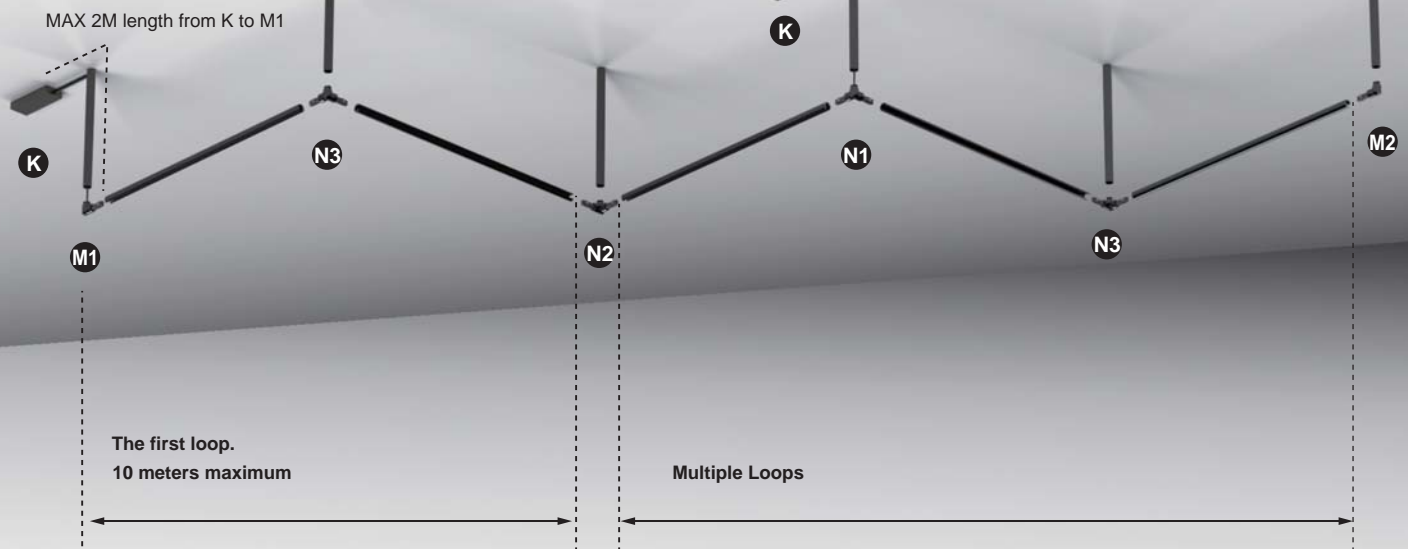

Power

J

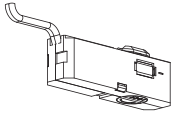

Adaptor With Power Cord

POC-01A
Length : 78.74"(200cm)
POC-01B
Length : 39.37"(100cm)

K

24V DC Driver

Connector

L1

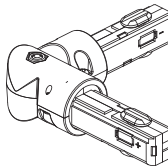

I-Connector with circuit

POC-02

L2

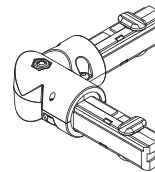

I-Connector without circuit

POC-02A

M1

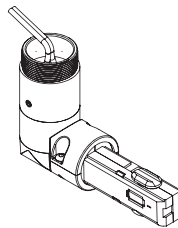

L-Connector with power cord

POC-03

M2

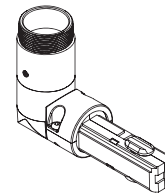

L-Connector without circuit

POC-03A

N1

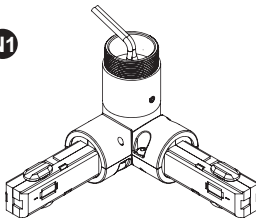

T-Connector with power cord

POC-04

N2

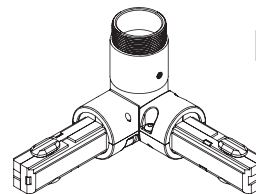

T-Connector without circuit

POC-04A

N3

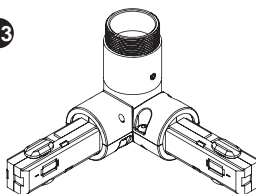

T-Connector with circuit

POC-04B

TT application

TT application is designed to use POT-01 track.
Together with accessories for horizontal & vertical connections.

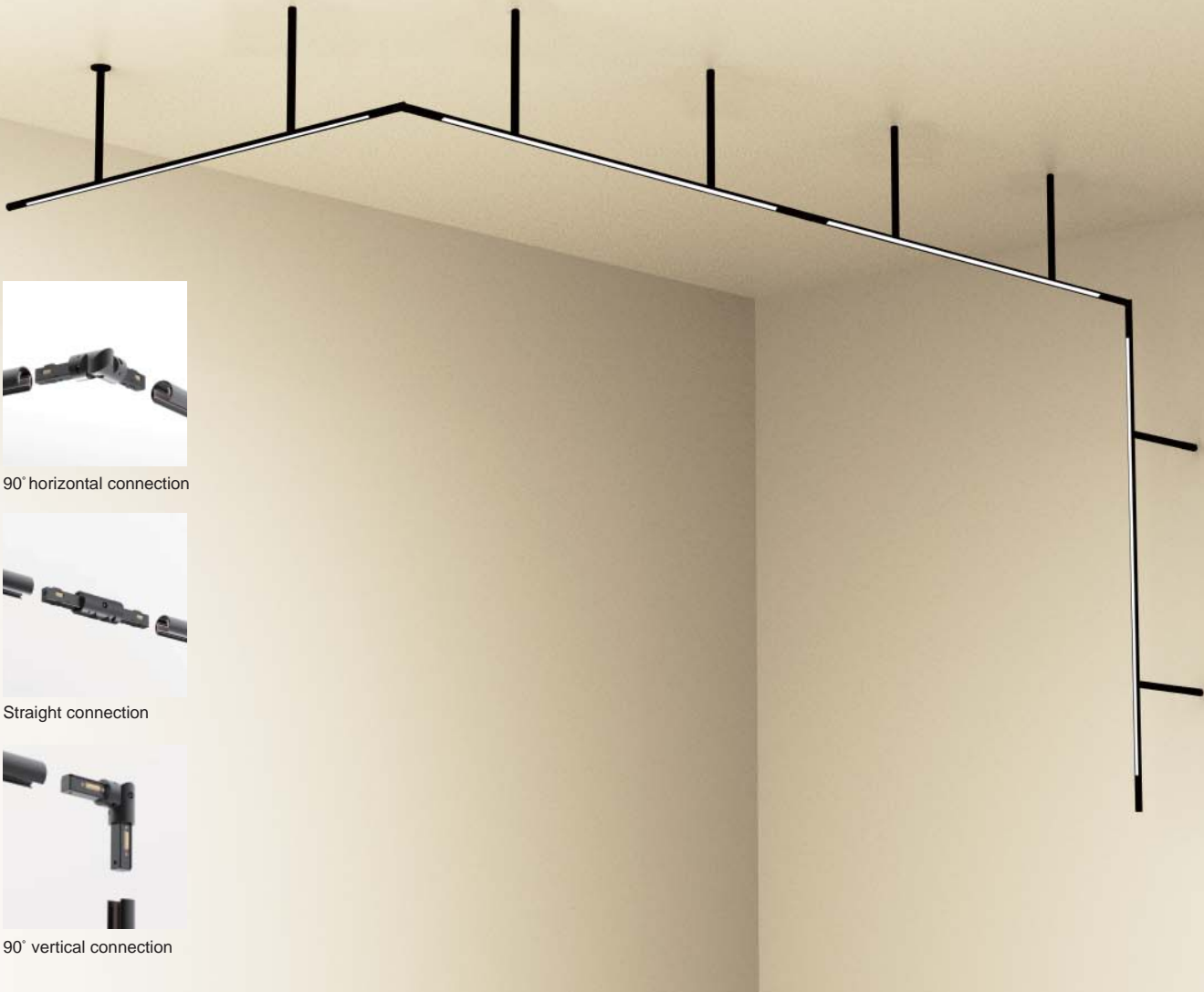

90° horizontal connection



Straight connection



90° vertical connection

71.97"(1828mm)

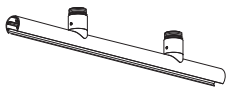

A x4



E x1



J x1

35.98"(914mm)

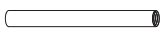

C x8



G x2



F x7

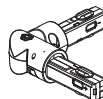

L1 x3

ITI application

ITI application is designed to use POT-02 track.
Together with accessories for 360 degrees rotation.



Rotate



Rotate



T connection



3-way connection

35.98"(914mm)

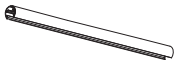

B x10

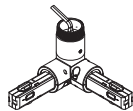

N1 x1



F x11

11.97"(304mm)



B x4

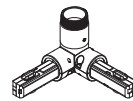

N2 x1

N3 x10



E x1

35.98"(914mm)

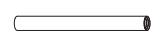

C x12



L1 x2

L2 x1

Mesh application

Mesh application uses both POT-01 & POT-02 track.
 This application creates up and down lighting effect by using POC-05 cross connector.

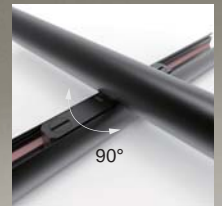

Cross connection



71.97"(1828mm)

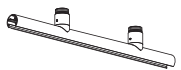

A x4



E x1

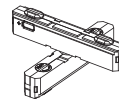

I x8

35.98"(914mm)

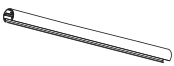

B x8



F x11

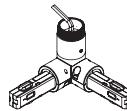

N1 x1

35.98"(914mm)

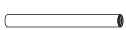

C x12



G x8

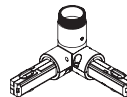

N2 x1

N3 x2



J x1

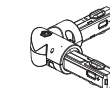

L1 x3

L2 x1

TT & ITI application

T-Connector allows POLE to be used in different angle & height application.
The connector can be bend 180 degrees max & rotate 360 degrees.

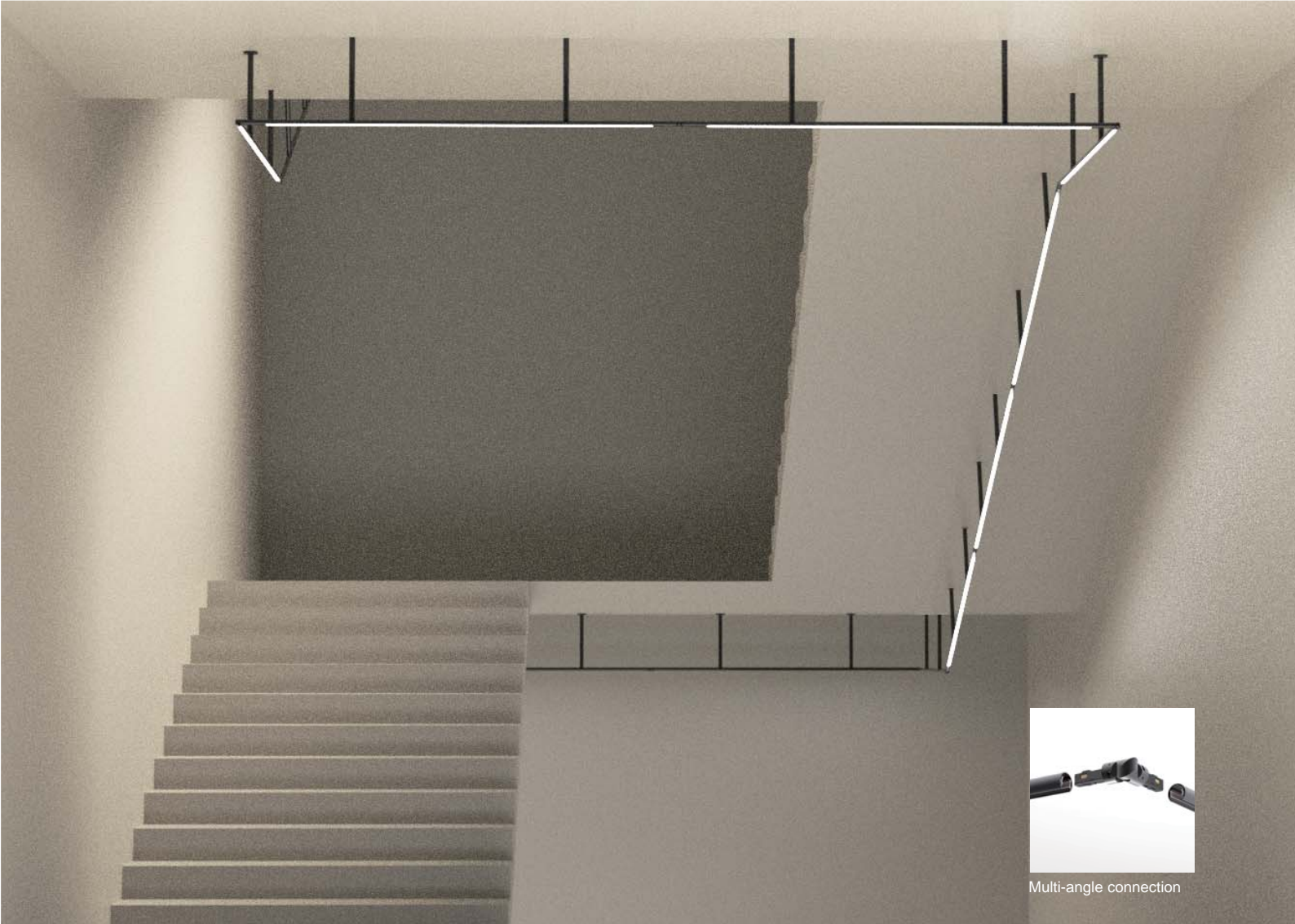

Multi-angle connection

35.98"(914mm)



B x ∞

35.98"(914mm)



C x ∞



E x ∞



F x ∞

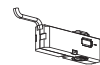

J x ∞

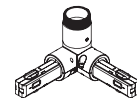

N x ∞



L x ∞

POLE-Pendant application

Can be pendant freely on the ceiling
 T-Connector is used at 90 degrees or greater.
 Suspension length can be adjusted to create stylish environment.



Pendant kit



Pendant kit+Power cord

35.98"(914mm)



B x8

11.97"(304mm)



B x4

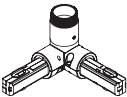

N2 x1

N3 x3

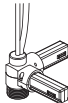

x1*

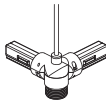

x3*

*Special parts is required, please contact with our sales rep for more info.

POLE-Straight application

Rotatable straight application creates all kinds of lighting possible.



Rotate



(Customize)



B x5



J x5

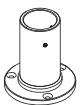

x10*

*Special parts is required, please contact with our sales rep for more info.

POLE-L

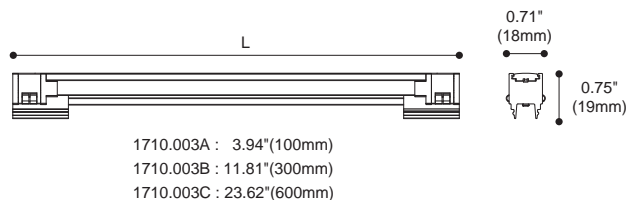

1710.003A-V

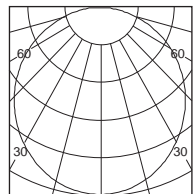

h (m)	D (m)	E (lx)
110°		
1.0	2.93	39
2.0	5.87	9
3.0	8.81	4
4.0	11.75	2
5.0	14.69	1

1710.003B-V

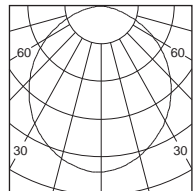

h (m)	D (m)	E (lx)
110°		
1.0	2.52	129
2.0	5.04	32
3.0	7.56	14
4.0	10.09	8
5.0	12.61	5

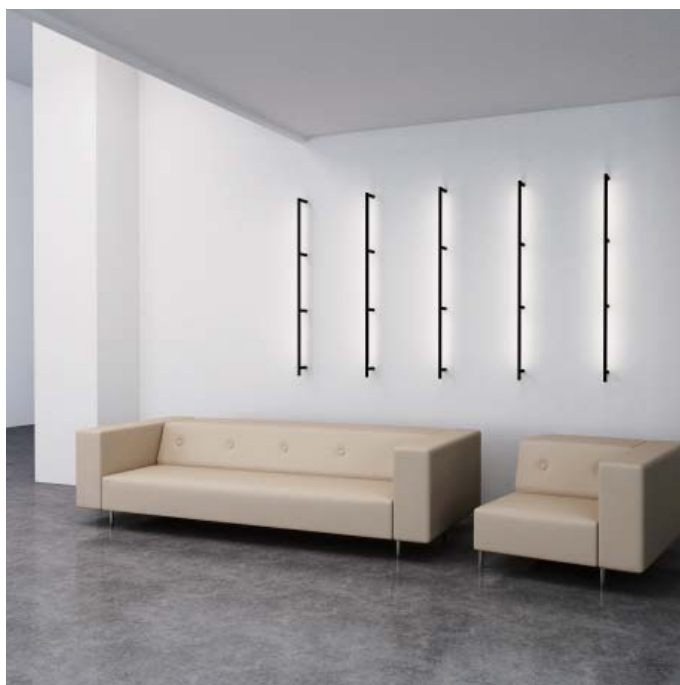

Colours ●
Black

Product performance

Article number	Module consumption	Voltage	System Lumen	Beam Angle	LED Type	LED q'ty	CCT/CRI
1710.003A-V	2 W	24VDC	115 (lm)	110°	SMD	15	30/80+
1710.003B-V	6 W	24VDC	344 (lm)	110°	SMD	60	30/80+
1710.003C-V	12 W	24VDC	616 (lm)	110°	SMD	120	30/80+



POLE-L-S

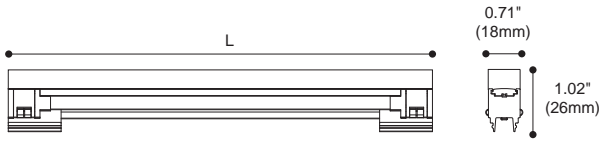

1710.004A : 3.94"(100mm)
 1710.004B : 11.81"(300mm)
 1710.004C : 23.62"(600mm)



1710.004A-V

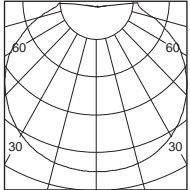

h (m)	D (m)	E (lx)
120°		
1.0	3.24	31
2.0	6.48	7
3.0	9.72	3
4.0	12.96	1
5.0	16.20	1

1710.004B-V

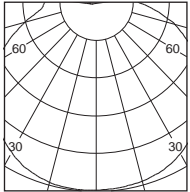

h (m)	D (m)	E (lx)
120°		
1.0	3.03	99
2.0	6.07	24
3.0	9.11	11
4.0	12.15	6
5.0	15.19	3

1710.004C-V

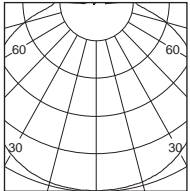

h (m)	D (m)	E (lx)
120°		
1.0	3.01	198
2.0	6.02	49
3.0	9.03	22
4.0	12.05	12
5.0	15.06	7



Colours ●
 Black

Product performance

Article number	Module consumption	Voltage	System Lumen	Beam Angle	LED Type	LED q'ty	CCT/CRI
1710.004A-V	2 W	24VDC	128 (lm)	120°	SMD	15	30/80+
1710.004B-V	6 W	24VDC	372 (lm)	120°	SMD	60	30/80+
1710.004C-V	12 W	24VDC	737 (lm)	120°	SMD	120	30/80+



POLE-S

1719.204-V

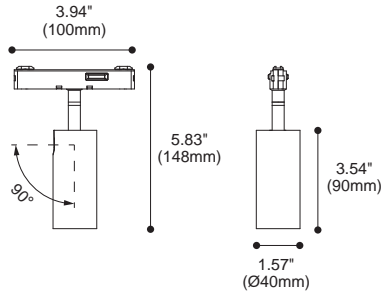

1719.204-V

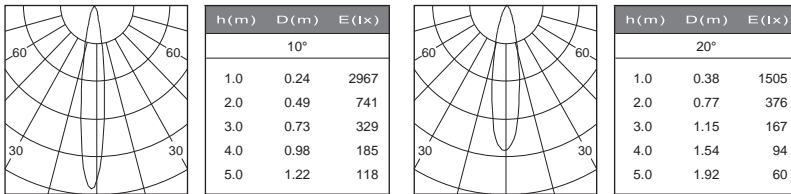

1719.203-V

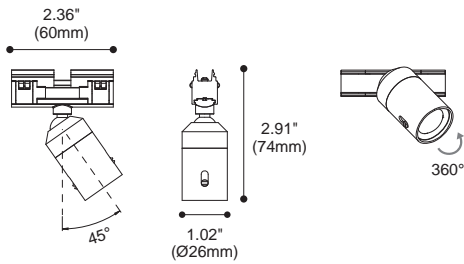

Zoom in 8°

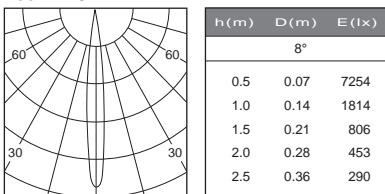

Zoom out 20°

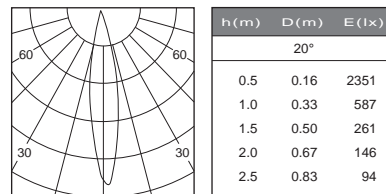

- Colours
 Black White
- Baffle :
 (1719.204) Black White Copper

Product performance

Article number	Module consumption	Voltage	Lumen	Beam Angle	CCT/CRI
1719.204-V	6.4W	24VDC	626 (lm)	10°/20°	30/90+
Article number	Module consumption	Voltage	System Lumen	Beam Angle	CCT/CRI
1719.203-V	2.9W	24VDC	50-70 (lm)	8°-20°	30/80+



POLE-K

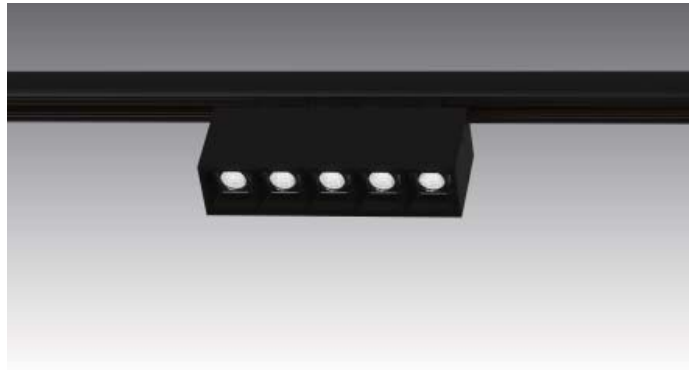
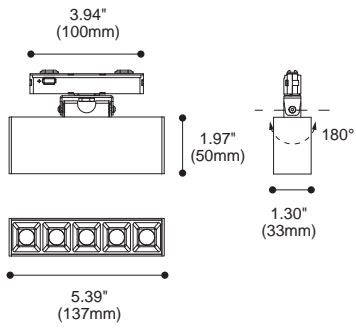

1917.400-5-V

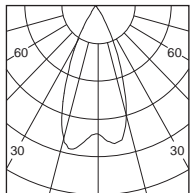

h (m)	D (m)	E (lx)
40°		
1.0	0.80	1543
2.0	1.60	385
3.0	2.40	171
4.0	3.20	96
5.0	4.00	61

- Colours ● ○
 Black White
- Baffle : ● ○ ●
 Black White Piano black

Product performance

Article number	Module consumption	Voltage	Lumen	Beam Angle	CCT/CRI
1917.400-5-V	11W	24VDC	1000 (lm)	15°/30°/40°	30/90+



POLE-C

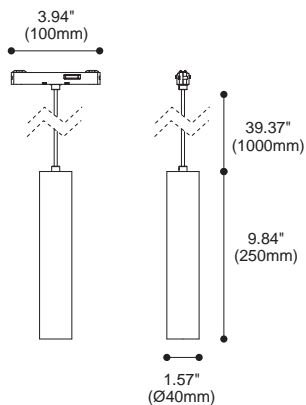

1716.100

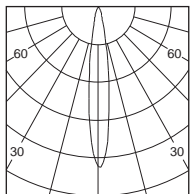

h (m)	D (m)	E (lx)
10°		
1.0	0.25	2984
2.0	0.50	746
3.0	0.75	331
4.0	1.00	186
5.0	1.25	119

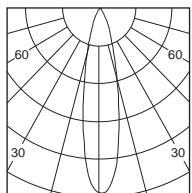

h (m)	D (m)	E (lx)
20°		
1.0	0.38	1476
2.0	0.77	369
3.0	1.16	164
4.0	1.55	92
5.0	1.94	59

- Colours
 Black White
- Baffle :
 Black White Copper

Product performance

Article number	Module consumption	Voltage	Lumen	Beam Angle	CCT/CRI
1716.100-V	6.4W	24VDC	626 (lm)	10°/ 20°	30/90+



POLE-KC

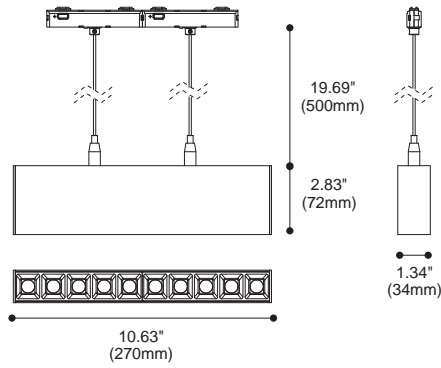

1917.401-10-V

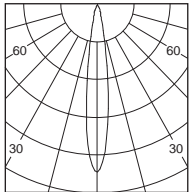

h (m)	D (m)	E (lx)
15°		
1.0	0.26	12704
2.0	0.52	3176
3.0	0.78	1412
4.0	1.05	794
5.0	1.31	508

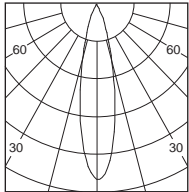

h (m)	D (m)	E (lx)
25°		
1.0	0.40	6526
2.0	0.81	1632
3.0	1.22	725
4.0	1.62	407
5.0	2.03	261

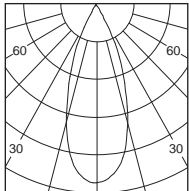

h (m)	D (m)	E (lx)
40°		
1.0	0.68	3318
2.0	1.36	829
3.0	2.04	368
4.0	2.72	207
5.0	3.40	132



- Colours ● Black ○ White
- Baffle : ● Black ○ White ● Piano black

Product performance

Article number	Module consumption	Voltage	Lumen	Beam Angle	CCT/CRI
1917.401-10-V	22W	24VDC	2000 (lm)	15°/25°/40°	30/90+

