



# SHUTTLE (AM) system



## SHUTTLE (AM)

An unique mini track connecting system designed to perform multiple tasks in professional shelf display.

Allowing mini spot, linear, undercabinet fixtures to be freely and easily combined in any location to get your ideal light distribute effect.

Plug and play for easy installation and maintenance, a great method to save labor cost.

Slim and light weight design fixtures showing elegant temperament.

# SHUTTLE (AM)

## SHUTTLE TRACK



RW-6-1000

Track

P.73

## SHUTTLE PROFILE



U-S Extrusion line

Aluminum profile (screw)

P.73



U Extrusion line

Aluminum profile (screw)

P.73

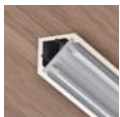

L Extrusion corner

Aluminum profile L (screw)

P.73



U-S-M Extrusion line

Aluminum profile (magnet)

P.73



U-M-V Extrusion line

Aluminum profile (magnet)

P.73



U-M-H Extrusion line

Aluminum profile (magnet)

P.73

## SHUTTLE MODULES

		Series name	Module consumption	Lumen	
		SHUTTLE-L	1.1W 4.2W 8W	110 (lm) 330 (lm) 660 (lm)	P.74
		SHUTTLE-L-S	1.1W 4.2W 8.0W	110 (lm) 330 (lm) 660 (lm)	P.75
		SHUTTLE-L-D	1.1W 4.2W 8W	110 (lm) 330 (lm) 660 (lm)	P.76
		SHUTTLE-B	4W	200 (lm)	P.77
		SHUTTLE-S	1.2W 2.7W	50~70 (lm) 50~70 (lm)	P.78
		SHUTTLE-S-F	2.7W	210 (lm)	P.79
		SHUTTLE-N	2.7W	50~70 (lm)	P.80
		SHUTTLE-J			P.82
		SHUTTLE-C			P.83

## SHUTTLE Track mounting

Smooth surface like glass, marble, etc., can be secured by adhesive tape



Rough surface like wood, aluminum, steel etc., can be secured by screws



Steel (Magent)

Steel (Magent)



SHUTTLE Track mounting

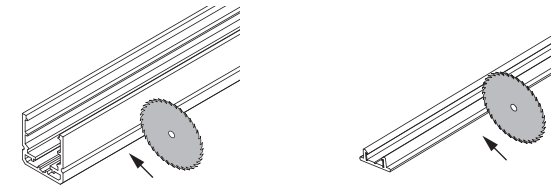

Cut ALU profile & track

Track (Adhesive tape)

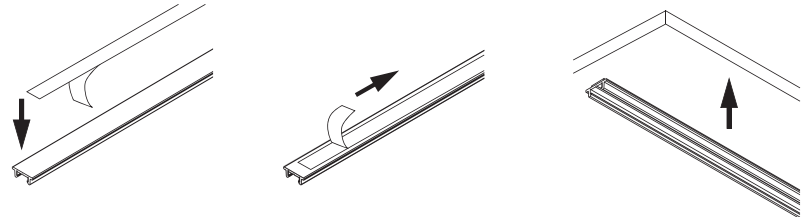
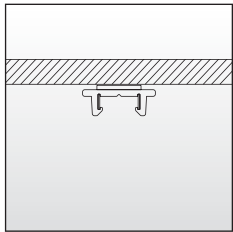

Apply adhesive tape on the back of the track, then stick onto the smooth surface.

Track (Mounting clip)

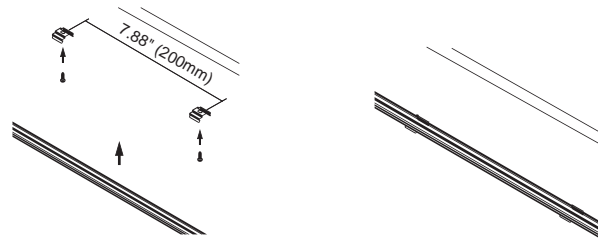
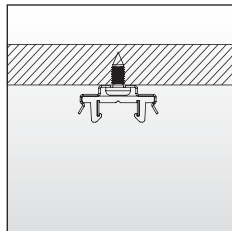
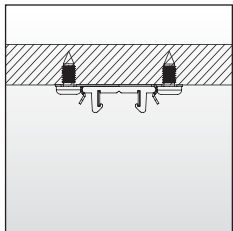

Distance between clips is 200mm, secure the clips with screw then click the track on the clips.

Aluminum profile (screw)

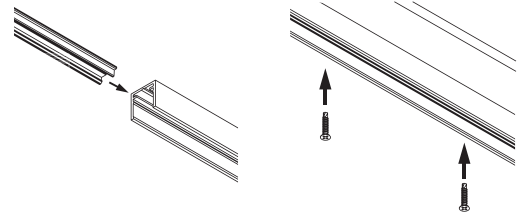
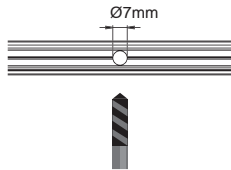
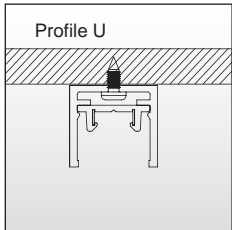
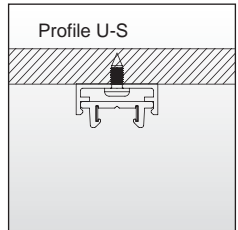

Pre-drill 7mm holes on the aluminum profile, secure the profile with screws on the surface, the height of the screw head shall not exceed 2mm.

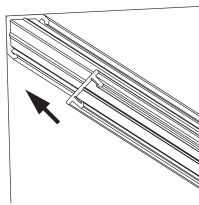
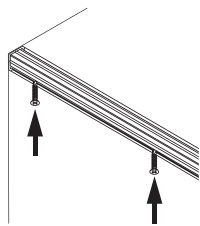
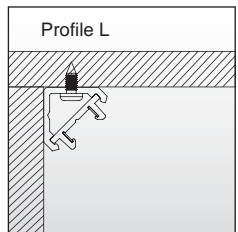

Secure the profile with screw, the height of the screw head shall not exceed 2mm.

Aluminum profile (magnet)

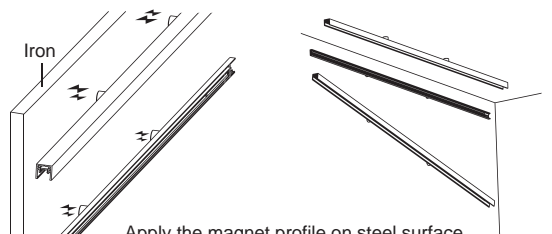
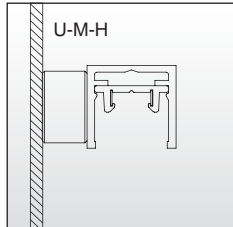
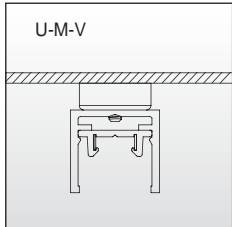
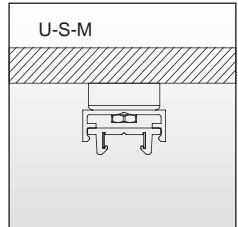

Apply the magnet profile on steel surface.

## SHUTTLE (AM)

Suitable for display shelves, and / or with movable laminates, or small area lighting. Tracks can be installed inside the extruded profile, making installation easy. Power feed can be added for other 24VDC fixtures not installed on the track. Making SHUTTLE a connecting system.



# SHUTTLE (AM)

Below is a exploded illustration, tracks can be linked via connection cord,  
Power feed can also be used for fixtures installed away from the track.  
To build up the lighting environment needed.

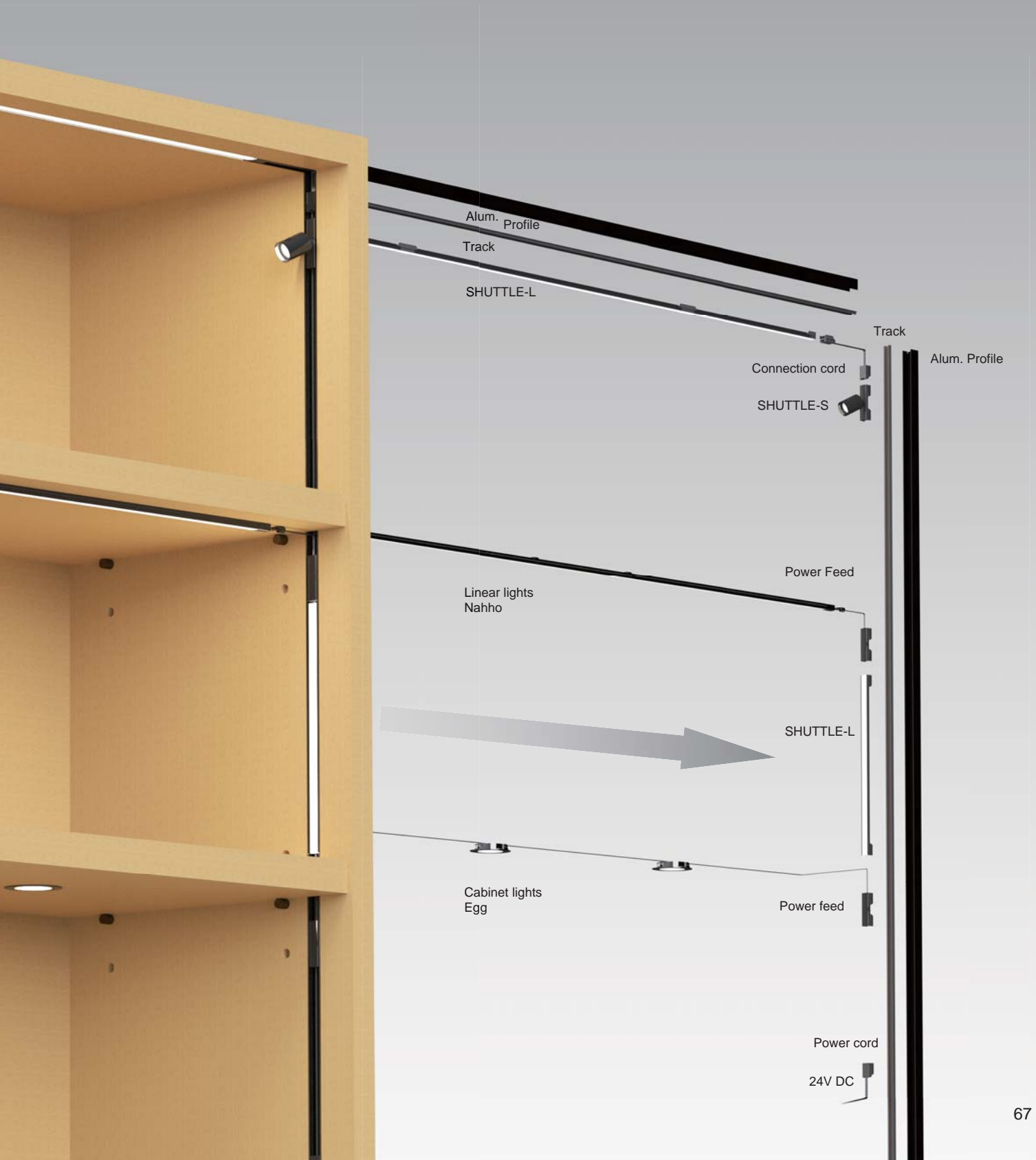



# SHUTTLE (AM) assemble system

Max wattage connection is suggested to be 80% of the driver's max. output wattage  
 When the max. wattage exceeds the driver's output wattage, new driver and track is needed.

ETL Standard  
 Only connect to adjacent units ,96W maximum.  
 Conform to UL STD. 2108 , Certified to CSA STD. C22.2 NO. 9.0.  
 Use only with CLASS 2 power unit.

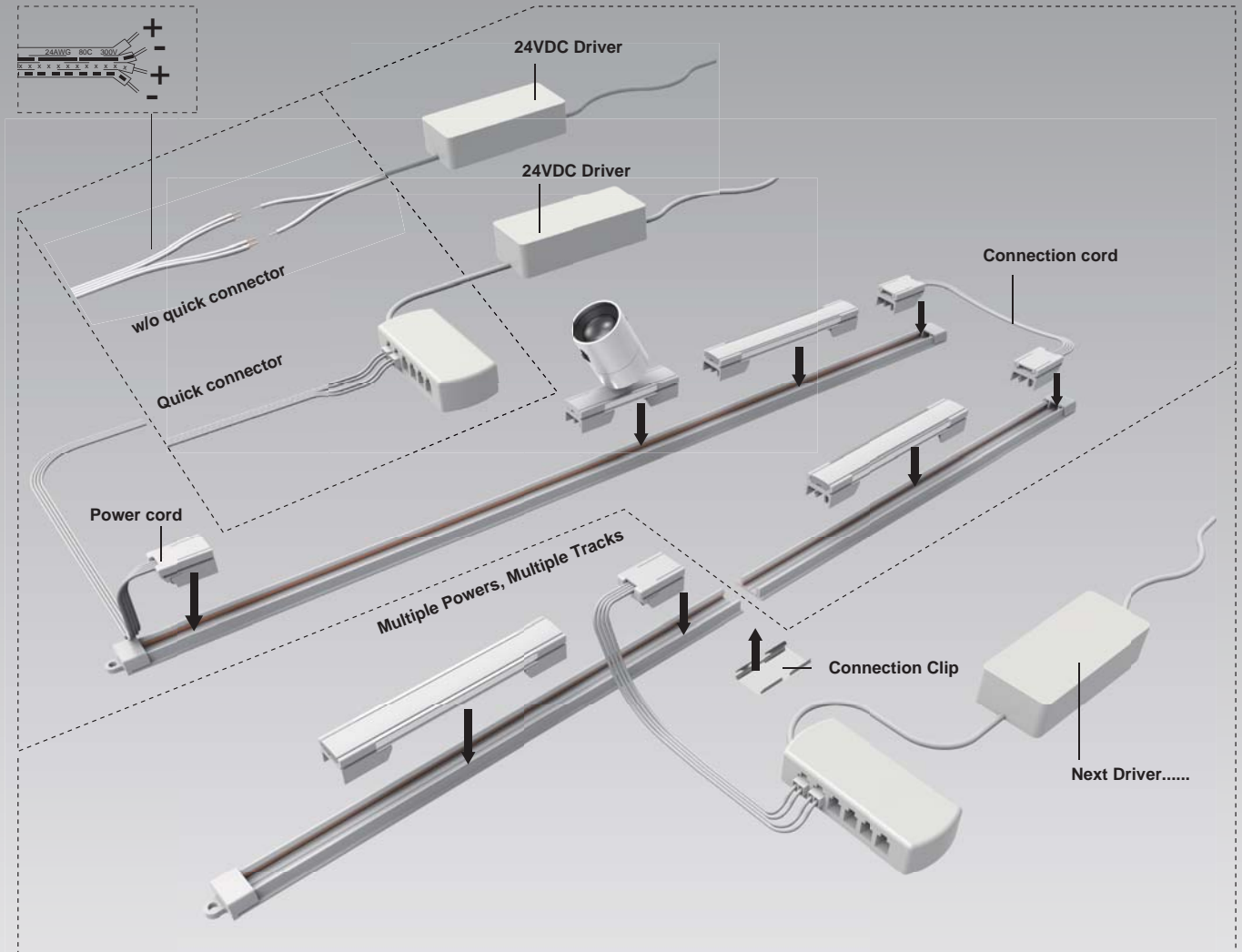

SHUTTLE-L can also be used between tracks to continue the circuit.

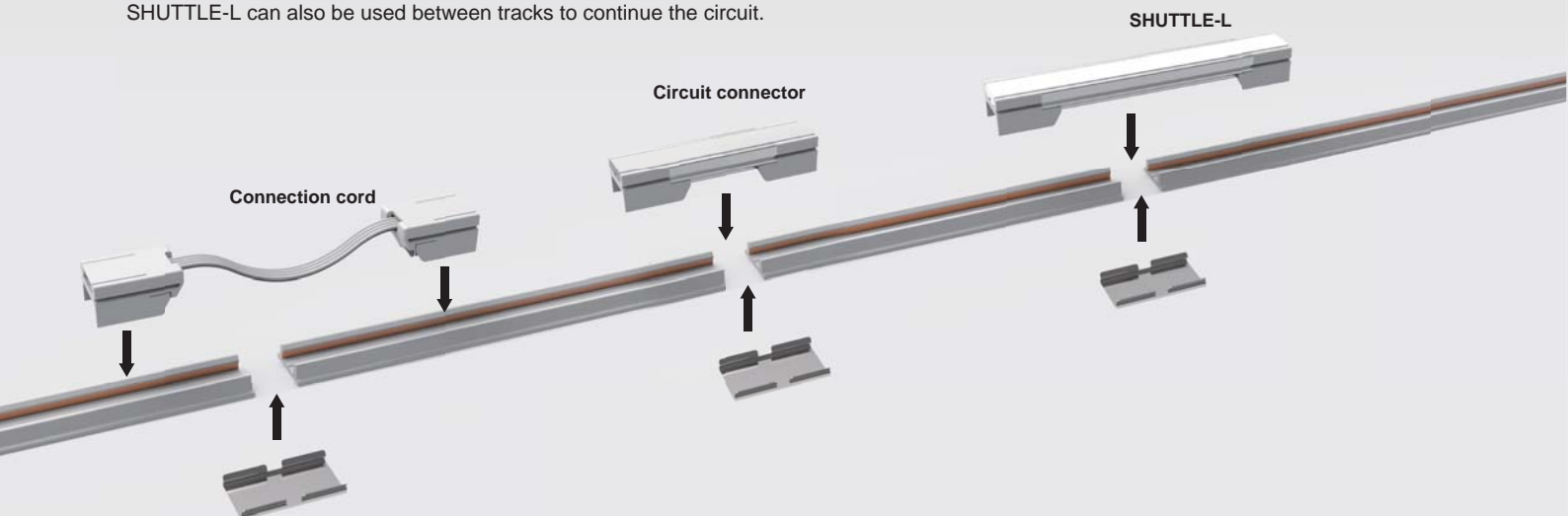

When maximum wattage has been reached, a sidefeed, new track and driver is needed to supply more power for continuous connection. SHUTTLE-L sidefeed can be used on one end of the new track for continuous linear light.

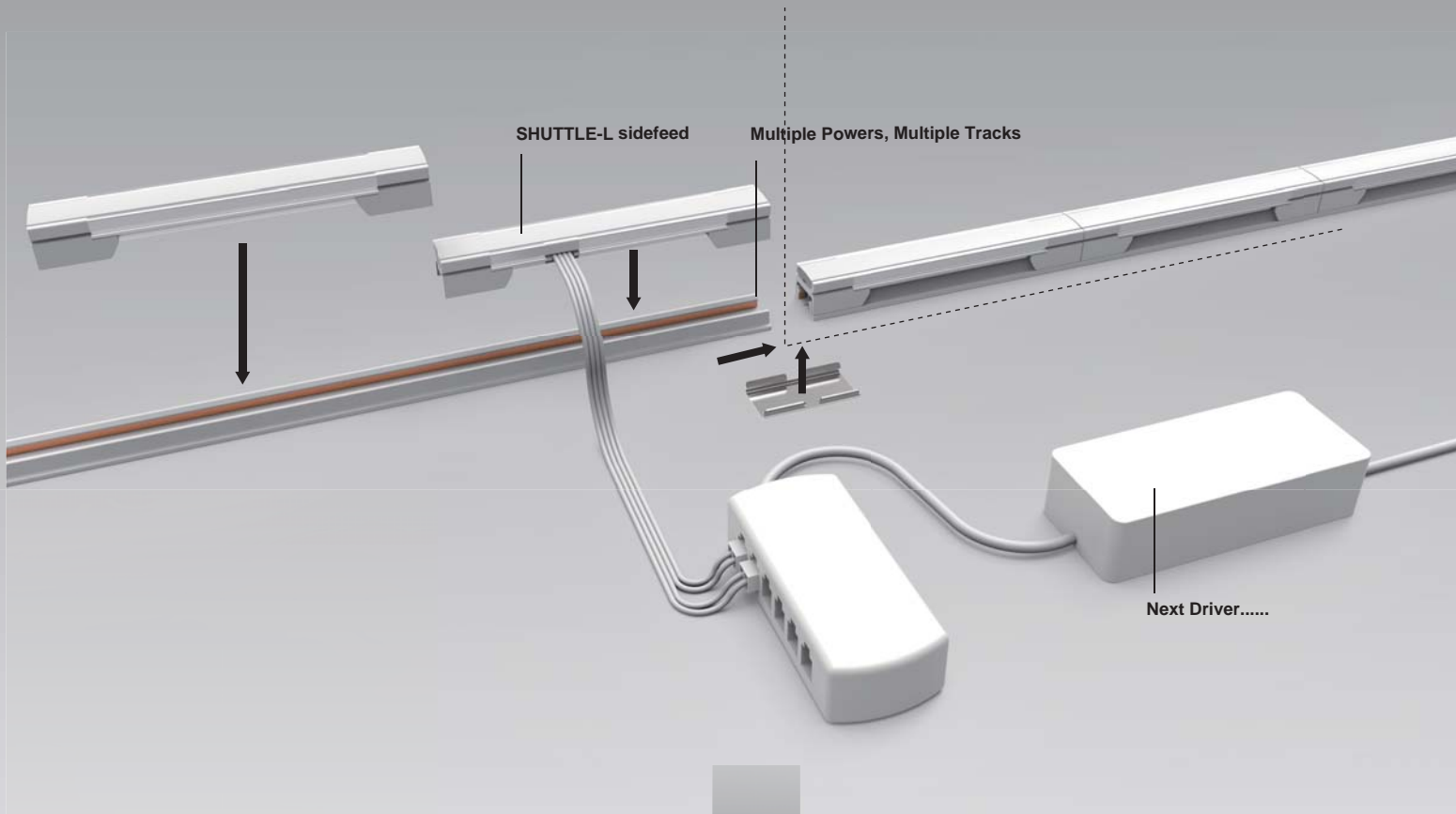

Continuous linear illustration.



# SHUTTLE (AM)

SHUTTLE fixtures can be clipped onto the track, tools-free, easy installation & maintenance.

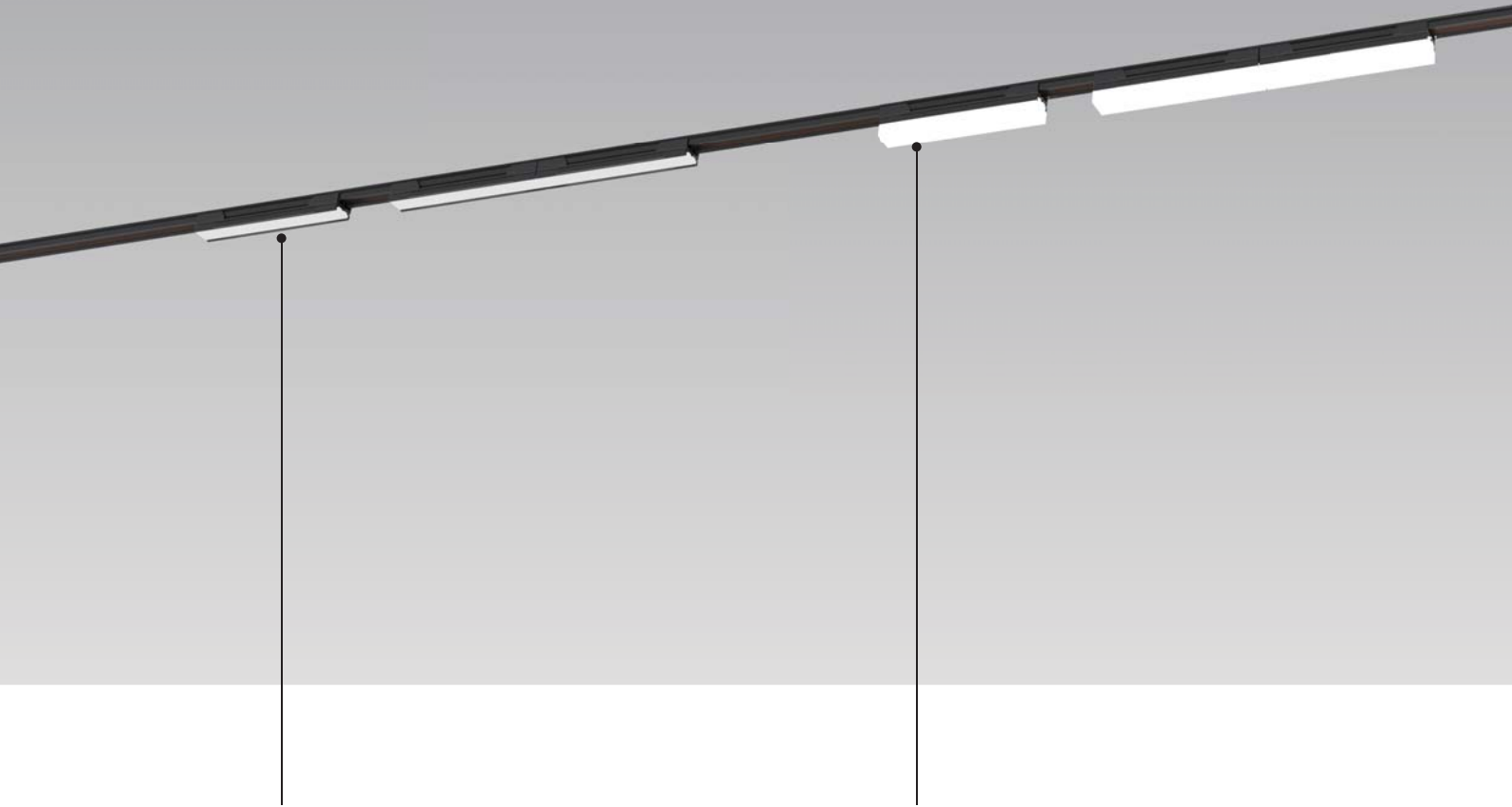

**SHUTTLE-L**  
Seamless design to make continuous lighting.  
Plug and play feature to repositioning the fixtures anywhere along the track.



**SHUTTLE-L-S**  
Seamless design with square diffuser



SHUTTLE-B  
Round module with dots-free effect



SHUTTLE-S  
Available in 1W and 2.2W, changing beam angle by adjusting the lever.

SHUTTLE-S-F  
2.2W spot light with higher output.

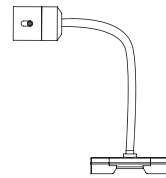

SHUTTLE-N  
Bendable tube provides more precision spot location. changing beam angle by adjusting the lever.

# SHUTTLE (AM)

## Accessories specifications

### Power cord

---

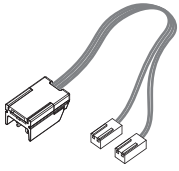

**CP-MOL-27-200**  
Power cord MOLEX male plug  
Length: 78.74"(200cm)

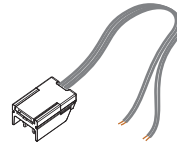

**CP-27-200**  
Power cord  
Length: 78.74"(200cm)

### Connection cord

---

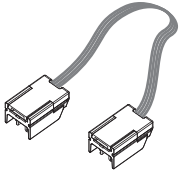

**CS-27-15**  
Connection cord Length:5.91"(15cm)  
**CS-27-30**  
Connection cord Length:11.81"(30cm)  
**CS-27-60**  
Connection cord Length:23.62"(60cm)

### Circuit connector

---

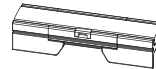

**CSC-27**

### Power feed

---

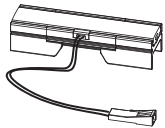

**CSP-27-60**  
**(Sidefeed)**  
I/P: 24VDC, O/P: 24VDC  
Connection cord with top female plug  
Length:23.62"(60cm)  
50W Max. Connection

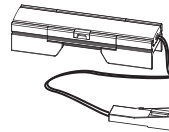

**CSP-A-27-60**  
**(Endfeed)**  
I/P: 24VDC, O/P: 24VDC  
Connection cord with top female plug  
Length:23.62"(60cm)  
50W Max. Connection





# SHUTTLE (AM)

Accessories specifications

Colours  Black  Grey

## Track

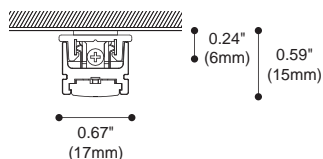
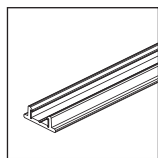

Article number L

RW-6-1000	39.37"(1000mm)
RW-6-2000	78.74"(2000mm)
RW-6-3000	118.11"(3000mm)

Track with adhesive tape

## Adhesive tape

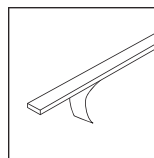

Article number L

BR-0011	39.37"(1000mm)
3M tape	

## End cap

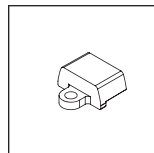

PC-0190

## Connection Clip

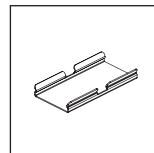

NS-0590

## Clips

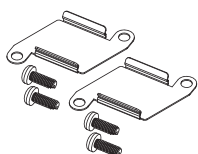

**NS-0588**  
Fixed clip (standard)

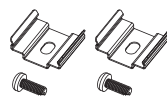
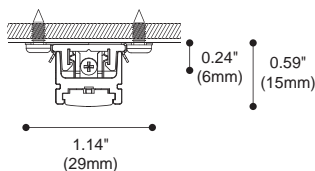

**NS-0589**  
Fixed clip (optional)

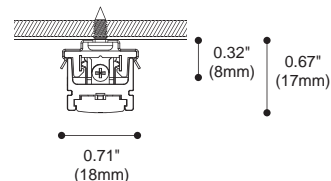

## Alum. profile

Colours  Black  Anodized Alum.

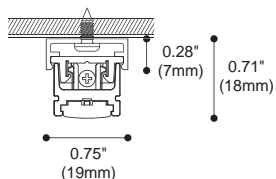
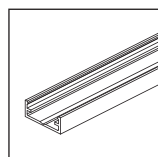

Article number L

SHT-01-1000	39.37"(1000mm)
SHT-01-2000	78.74"(2000mm)
SHT-01-3000	118.11"(3000mm)

U-S Extrusion line

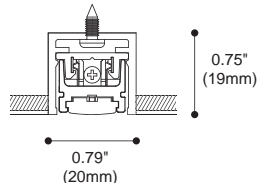
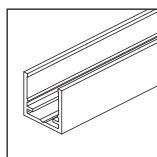

Article number L

SHT-02-1000	39.37"(1000mm)
SHT-02-2000	78.74"(2000mm)
SHT-02-3000	118.11"(3000mm)

U Extrusion line

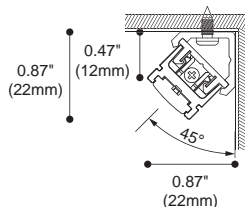
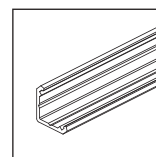

Article number L

SHT-03-1000	39.37"(1000mm)
SHT-03-2000	78.74"(2000mm)
SHT-03-3000	118.11"(3000mm)

L Extrusion corner

## Alum. Profile with magnet

Colours  Black  Anodized Alum.

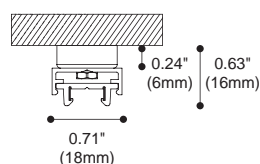
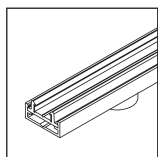

Article number L

SHT-04-1000	39.37"(1000mm)
SHT-04-2000	78.74"(2000mm)
SHT-04-3000	118.11"(3000mm)

U-S-M Extrusion line

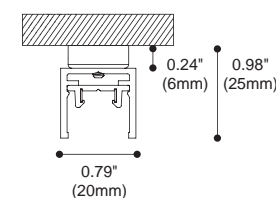
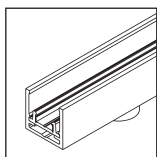

Article number L

SHT-05-1000	39.37"(1000mm)
SHT-05-2000	78.74"(2000mm)
SHT-05-3000	118.11"(3000mm)

U-M-V Extrusion line

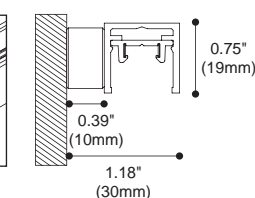
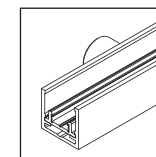

Article number L

SHT-06-1000	39.37"(1000mm)
SHT-06-2000	78.74"(2000mm)
SHT-06-3000	118.11"(3000mm)

U-M-H Extrusion line

# SHUTTLE-L

1510.023A : 3.94"(100mm)

1510.023B : 11.81"(300mm)

1510.023C : 23.62"(600mm)

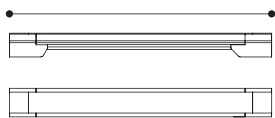

0.67"  
(17mm)

0.55"  
(14mm)



Sidefeed

1510.023D : 3.94"(100mm)



## 1510.023A

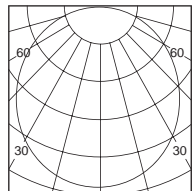

h (m)	D (m)	E (lx)
115°		
0.5	1.56	110
1.0	3.12	27
1.5	4.69	12
2.0	6.25	6
2.5	7.81	4

## 1510.023B

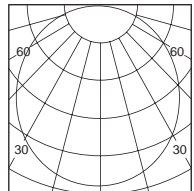

h (m)	D (m)	E (lx)
115°		
0.5	1.56	578
1.0	3.12	144
1.5	4.68	64
2.0	6.24	36
2.5	7.80	23

## 1510.023C

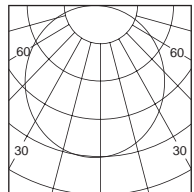

h (m)	D (m)	E (lx)
115°		
0.5	1.49	807
1.0	2.99	201
1.5	4.48	89
2.0	5.98	50
2.5	7.47	32

Colours    
Black Anodized Alum.

Product performance

Article number	Module consumption	Voltage	System Lumen	Beam Angle	LED Type	LED q'ty	CCT/CRI
1510.023A	1.1 W	24VDC	110 (lm)	115°	SMD	14	30/80+
1510.023B	4.2 W	24VDC	330 (lm)	115°	SMD	42	30/80+
1510.023C	8.0 W	24VDC	660 (lm)	115°	SMD	84	30/80+

Sidefeed

1510.023D	1.1 W	24VDC	110 (lm)	115°	SMD	14	30/80+
-----------	-------	-------	----------	------	-----	----	--------



# SHUTTLE-L-S

1510.026A : 3.94"(100mm)  
 1510.026B : 11.81"(300mm)  
 1510.026C : 23.62"(600mm)

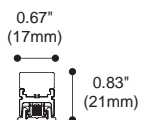
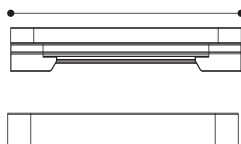

Sidefeed

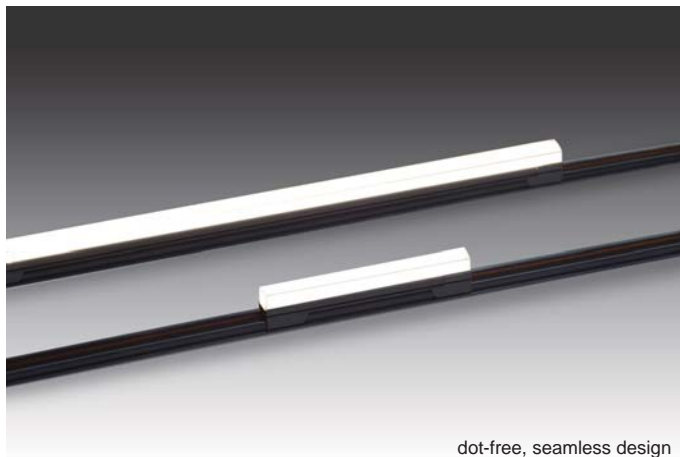
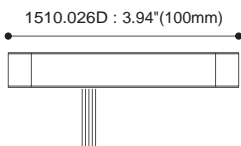

dot-free, seamless design

## 1510.026A

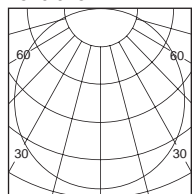

h (m)	D (m)	E (lx)
130°		
0.5	1.62	91
1.0	3.25	22
1.5	4.88	10
2.0	6.51	5
2.5	8.13	3

## 1510.026B

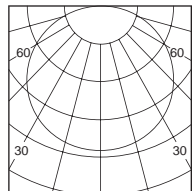

h (m)	D (m)	E (lx)
130°		
0.5	1.51	463
1.0	3.02	115
1.5	4.53	51
2.0	6.05	28
2.5	7.56	18

## 1510.026C

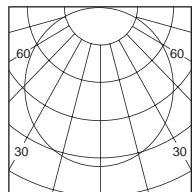

h (m)	D (m)	E (lx)
130°		
0.5	1.50	666
1.0	3.00	166
1.5	4.51	74
2.0	6.01	41
2.5	7.51	26

Colours Black Anodized Alum.

Product performance

Article number	Module consumption	Voltage	System Lumen	Beam Angle	LED Type	LED q'ty	CCT/CRI
1510.026A	1.1 W	24VDC	110 (lm)	130°	SMD	14	30/80+
1510.026B	4.2 W	24VDC	330 (lm)	130°	SMD	42	30/80+
1510.026C	8.0 W	24VDC	660 (lm)	130°	SMD	84	30/80+

Sidefeed

1510.026D	1.1 W	24VDC	110 (lm)	130°	SMD	14	30/80+
-----------	-------	-------	----------	------	-----	----	--------



# SHUTTLE-L-D

1810.001A : 3.94"(100mm)  
 1810.001B : 11.81"(300mm)  
 1810.001C : 23.62"(600mm)

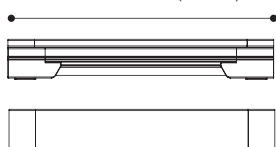

0.59"  
(15mm)  
 0.59"  
(15mm)

Sidefeed

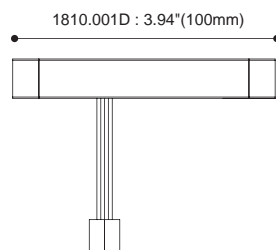

1810.001D : 3.94"(100mm)



dot-free, seamless design

Colours    
 Black Anodized Alum.

Product performance

Article number	Module consumption	Voltage	System Lumen	Beam Angle	LED Type	LED q'ty	CCT/CRI
1810.001A	1.1 W	24VDC	110 (lm)	130°	SMD	21	30/80+
1810.001B	4.2 W	24VDC	330 (lm)	130°	SMD	63	30/80+
1810.001C	8.0 W	24VDC	660 (lm)	130°	SMD	126	30/80+

Sidefeed

1810.001D	1.1 W	24VDC	110 (lm)	130°	SMD	21	30/80+
-----------	-------	-------	----------	------	-----	----	--------



# SHUTTLE-B

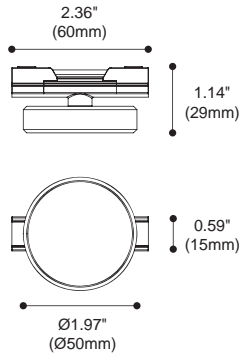

1768.100

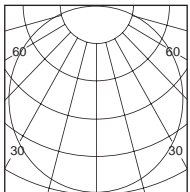

h (m)	D (m)	E (lx)
	113°	
0.5	1.53	259
1.0	3.07	64
1.5	4.61	28
2.0	6.15	16
2.5	7.69	10

Colours    
Black Anodized Alum.

Product performance

Article Number	Module consumption	Voltage	System Lumen	Beam Angle	LED Type	LED q'ty	CCT/CRI
1768.100	4 W	24VDC	200 (lm)	113°	SMD	48	30/80+





# SHUTTLE-S

1619.200

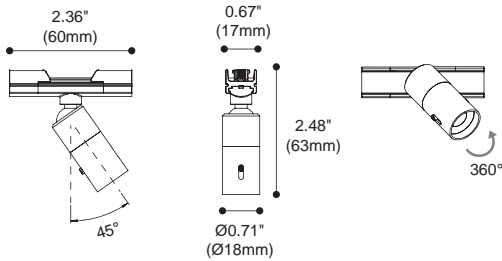

Zoom in 30°

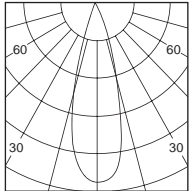

h (m)	D (m)	E (lx)
30°		
0.5	0.24	761
1.0	0.49	190
1.5	0.74	84
2.0	0.98	47
2.5	1.23	30

Zoom out 55°

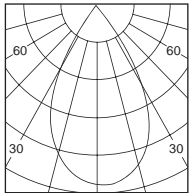

h (m)	D (m)	E (lx)
55°		
0.5	0.51	370
1.0	1.02	92
1.5	1.53	41
2.0	2.04	23
2.5	2.55	14



1619.205

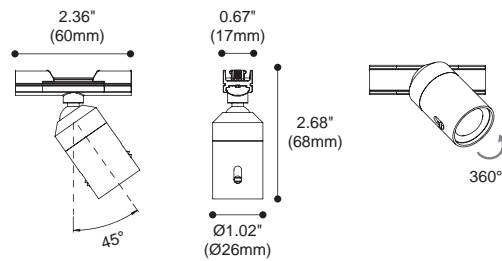

Zoom in 8°

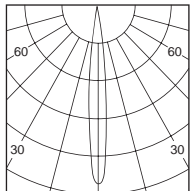

h (m)	D (m)	E (lx)
8°		
0.5	0.07	7254
1.0	0.14	1814
1.5	0.21	806
2.0	0.28	453
2.5	0.36	290

Zoom out 20°

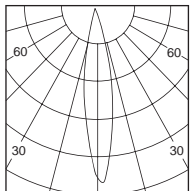

h (m)	D (m)	E (lx)
20°		
0.5	0.16	2351
1.0	0.33	587
1.5	0.50	261
2.0	0.67	146
2.5	0.83	94



Colours  Black  Anodized Alum.

Product performance

Article Number	Module consumption	Voltage	System Lumen	Beam Angle	LED Type	LED q'ty	CCT/CRI
1619.200	1.2 W	24VDC	50~70 (lm)	30°-55°	High Power	1	30/80+
1619.205	2.7 W	24VDC	50~70 (lm)	8°-20°	High Power	1	30/80+



# SHUTTLE-S-F

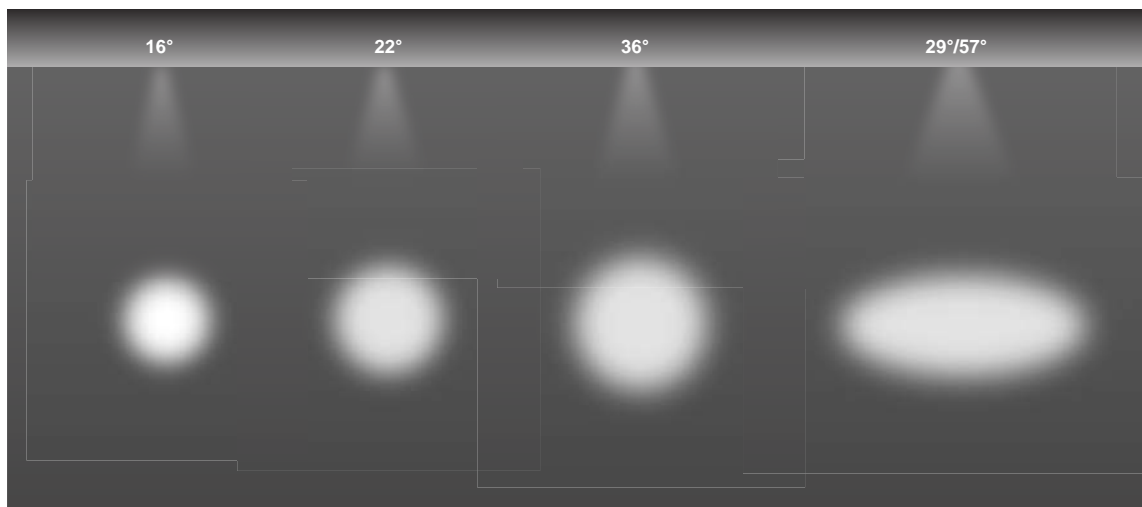
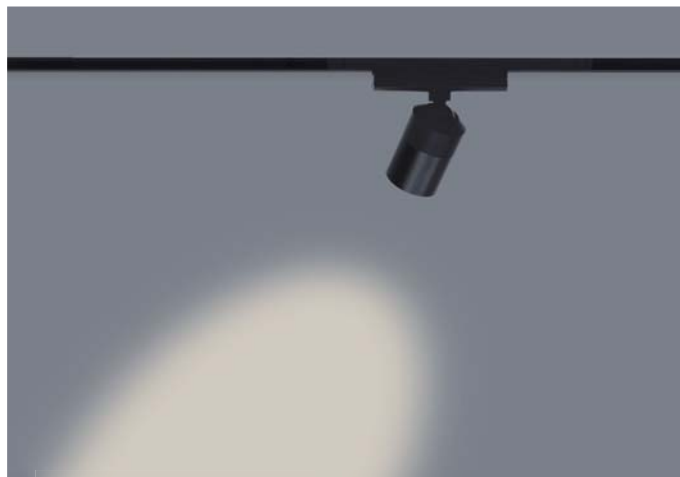
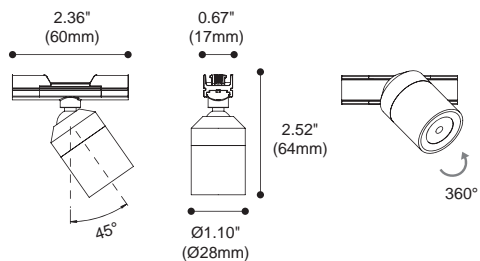

1719.209

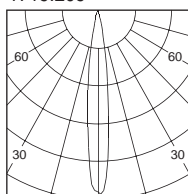

h (m)	D (m)	E (lx)
<b>16°</b>		
0.5	0.11	9874
1.0	0.22	2468
1.5	0.34	1097
2.0	0.45	617
2.5	0.57	395

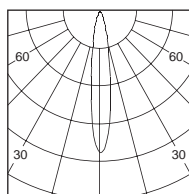

h (m)	D (m)	E (lx)
<b>22°</b>		
0.5	0.13	4310
1.0	0.27	1078
1.5	0.41	478
2.0	0.55	269
2.5	0.69	172

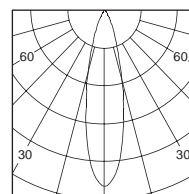

h (m)	D (m)	E (lx)
<b>36°</b>		
0.5	0.21	2488
1.0	0.43	622
1.5	0.65	276
2.0	0.87	155
2.5	1.09	99

Colours   
Black Anodized Alum.

Product performance

Article Number	Module consumption	Voltage	System Lumen	Beam Angle	LED Type	LED q'ty	CCT/CRI
1719.209	2.7 W	24VDC	210 (lm)	16°/ 22°/ 36°/ 29°x57°	High Power	1	30/80+



# SHUTTLE-N

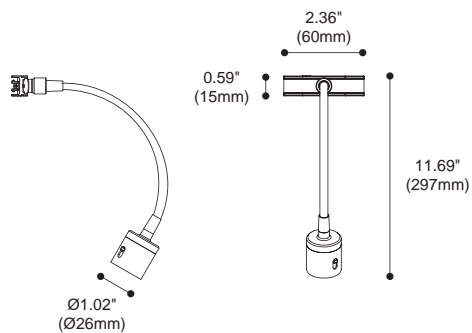

Zoom in 8°

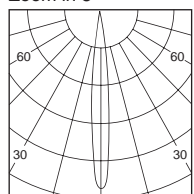

h (m)	D (m)	E (lx)
8°		
0.5	0.07	7254
1.0	0.14	1814
1.5	0.21	806
2.0	0.28	453
2.5	0.36	290

Zoom out 20°

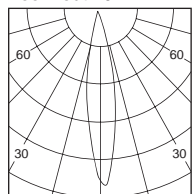

h (m)	D (m)	E (lx)
20°		
0.5	0.16	2351
1.0	0.33	587
1.5	0.50	261
2.0	0.67	146
2.5	0.83	94



Colours ●  
Black

## Product performance

Article Number	Module consumption	Voltage	System Lumen	Beam Angle	LED Type	LED q'ty	CCT/CRI
1617.502	2.7 W	24VDC	50-70 (lm)	8°-20°	High Power	1	30/80+





# SHUTTLE – J

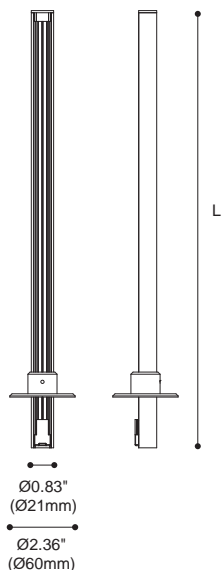

Article number	L
SHT-07-0354	13.94"(354mm)
SHT-07-0504	19.84"(504mm)



Colours  Black  Anodized Alum.

## Cut extrusion pole & power supply track

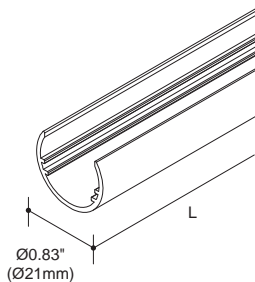
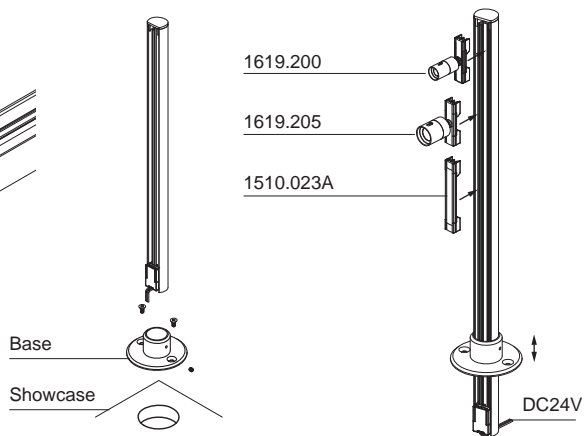
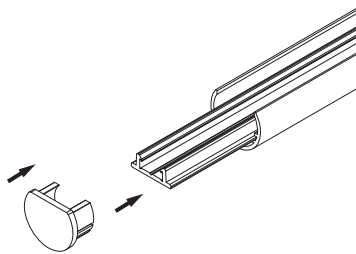
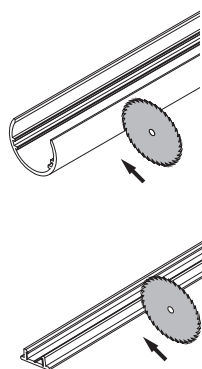

## Accessories

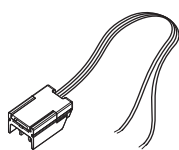

Models : CP-27-200  
Type : Power cord  
Wire Length : 78.74"(200cm)

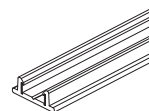

Models : RW-6-1000  
Type : Power supply track  
39.37"(1000mm)

Models : RW-6-2000  
Type : Power supply track  
78.74"(2000mm)

## Product performance

Number	L
STJ-01-0500	19.69"(500mm)
STJ-01-1000	39.37"(1000mm)
STJ-01-2000	78.74"(2000mm)



Models : STI-01  
Type : Base



Models : STC-01  
Type : End cap



# SHUTTLE – C

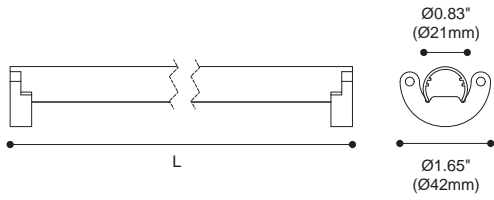

Colours  Black  Anodized Alum.

## Cut extrusion pole & power supply track

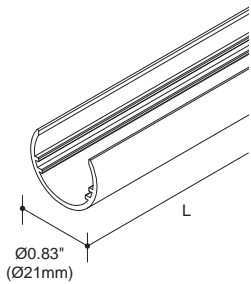
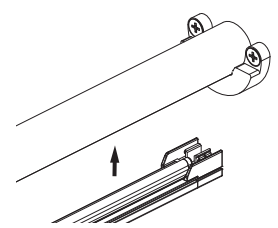
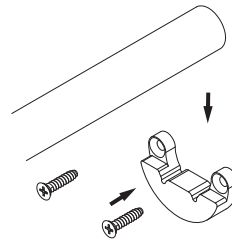
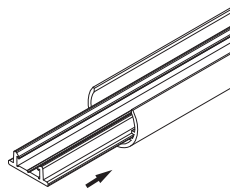
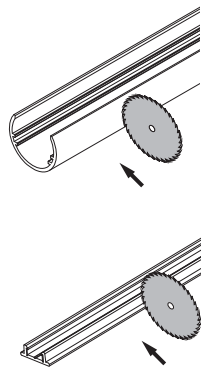

## Accessories

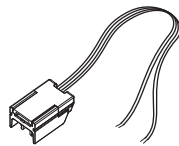

Models : CP-27-200  
Type : Power cord  
Wire Length : 78.74\"(200cm)

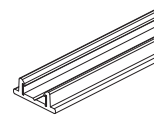

Models : RW-6-1000  
Type : Power supply track  
39.37\"(1000mm)

Models : RW-6-2000  
Type : Power supply track  
78.74\"(2000mm)

## Product performance

Number	L
STJ-01-0500	19.69\"(500mm)
STJ-01-1000	39.37\"(1000mm)
STJ-01-2000	78.74\"(2000mm)

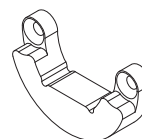

Models : STI-02  
Type : Base

# SHUTTLE

Can be used as track to power up other 24V DC fixtures

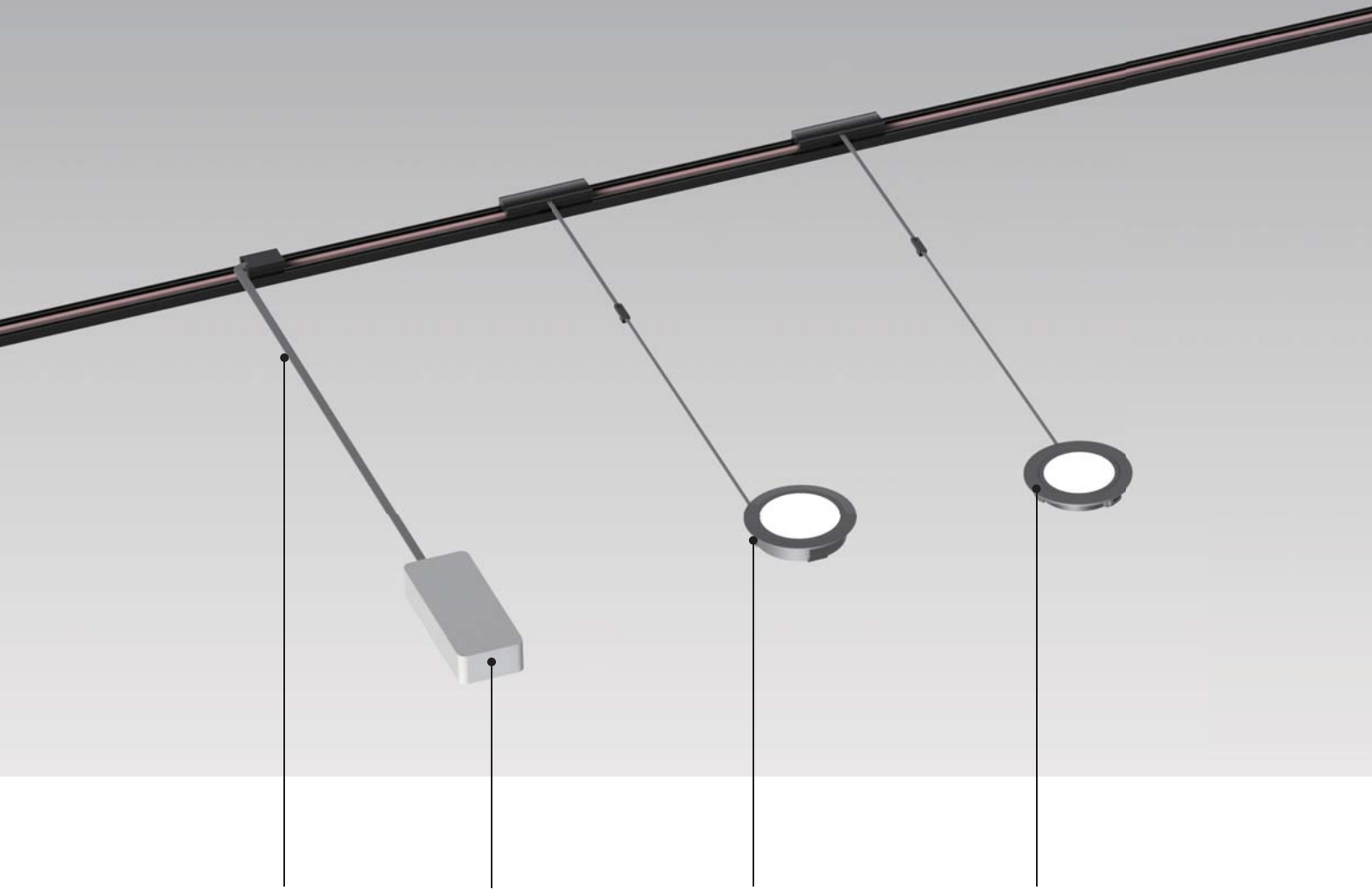

Power Cord  
connects to 24VDC driver



Driver  
24VDC



Egg 4W  
ALU housing helps  
heat dissipation



Akis 1.7W  
Plastic housing for  
economical solution



Tobey  
Smooth plastic with  
black or white finish.



Nahho  
Multiple length available,  
also come with different  
diffusers.

LINEAR LIGHTS



Colours Anodized Alum.

**NAHHO-SS**



Series name	Article number	Module consumption	Voltage	Length
NAHHO-SS	1510.008F	1.5 W (X14PCS)	24VDC	3.94"(100mm)
	1510.008H	4 W (X42PCS)	24VDC	11.22"(285mm)
	1510.008I	8 W (X84PCS)	24VDC	22.24"(565mm)
	1510.008J	12 W (X126PCS)	24VDC	33.27"(845mm)
	1510.008K	16 W (X168PCS)	24VDC	44.21"(1123mm)
	1510.008L	4 W (X42PCS)	24VDC	11.22"(285mm)

**NAHHO-SS-S**



Series name	Article number	Module consumption	Voltage	Length
NAHHO-SS-S	1510.022F	1.5 W (X14PCS)	24VDC	3.94"(100mm)
	1510.022H	4 W (X42PCS)	24VDC	11.22"(285mm)
	1510.022I	8 W (X84PCS)	24VDC	22.24"(565mm)
	1510.022J	12 W (X126PCS)	24VDC	33.27"(845mm)
	1510.022K	16 W (X168PCS)	24VDC	44.21"(1123mm)
	1510.022L	4 W (X42PCS)	24VDC	11.22"(285mm)

**NAHHO-SS-R**



Series name	Article number	Module consumption	Voltage	Length
NAHHO-SS-R	1510.021F	1.5 W (X14PCS)	24VDC	3.94"(100mm)
	1510.021H	4 W (X42PCS)	24VDC	11.22"(285mm)
	1510.021I	8 W (X84PCS)	24VDC	22.24"(565mm)
	1510.021J	12 W (X126PCS)	24VDC	33.27"(845mm)
	1510.021K	16 W (X168PCS)	24VDC	44.21"(1123mm)
	1510.021L	4 W (X42PCS)	24VDC	11.22"(285mm)

CABINET LIGHTS

Colours Black White

**TOBEY-8D6+**



**TOBEY-8D6-S+**



Series name	Article number	Module consumption	Voltage
TOBEY-8D6+	1263.119B	2.4 W	24VDC
TOBEY-8D6-S+	1263.119C	2.4 W	24VDC

**TOBEY-C8D6+**



**TOBEY-C8D6-S+**



Series name	Article number	Module consumption	Voltage
TOBEY-C8D6+	1363.119B	2.4 W	24VDC
TOBEY-C8D6-S+	1363.119C	2.4 W	24VDC

Colours Black White Chrome Matt chrome Satin Nickel

**AKIS-R-II**



**BANIO-R-II**



Series name	Article number	Module consumption	Voltage
AKIS-R-II	1468.106A	1.7 W	24VDC
BANIO-R-II	1468.113A	1.7 W	24VDC

Colours Black White Silver Satin Nickel

**EGG 4W**



Series name	Article number	Module consumption	Voltage
EGG 4W	1468.107A	4 W	24VDC

