

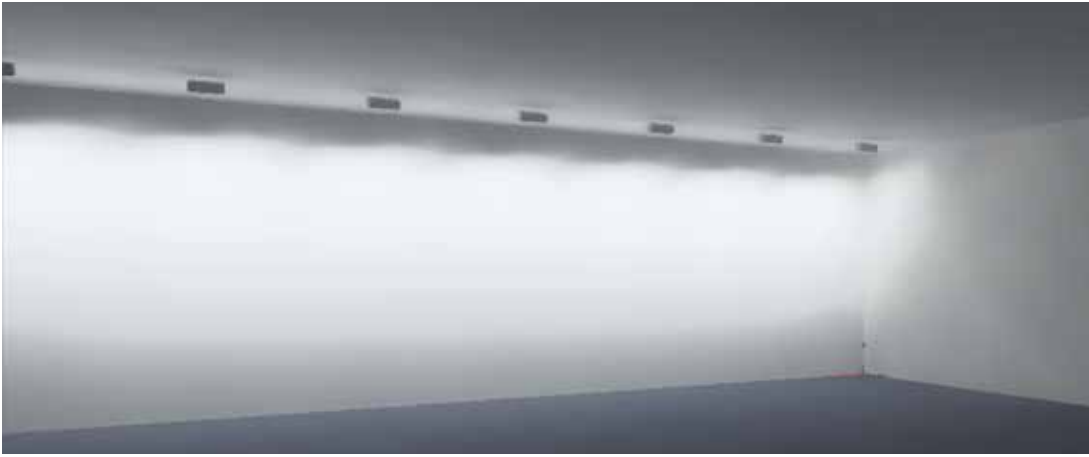



DIPPER

Material: Aluminum extrusion with plastic end cap & aluminum reflector
Dipper series is commonly used in walkway, ceiling, wallwash or shelf lighting. Provide economical lighting solution.



Wallwash A

H:320cm
Distance to the wall:100cm
Distance between fixtures:150cm

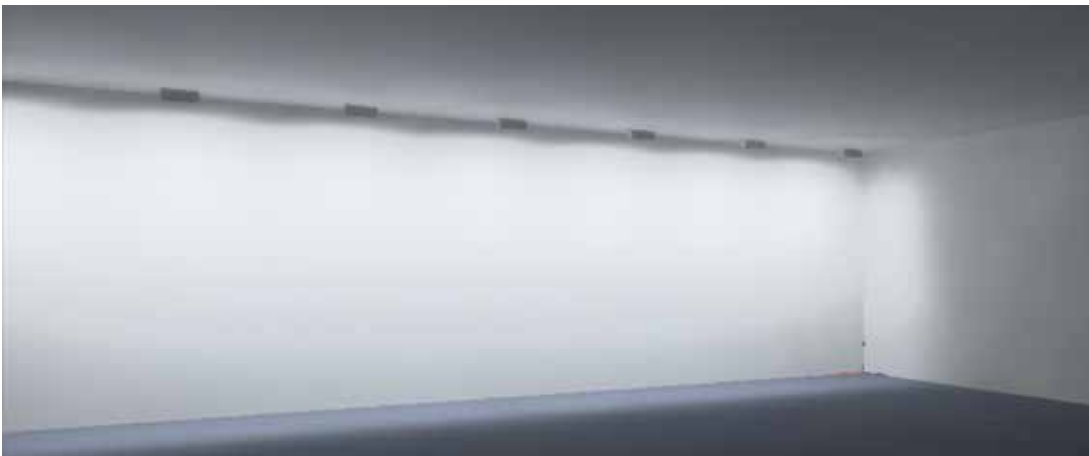

Wallwash B

H:320cm
Distance to the wall:100cm
Distance between fixtures:150cm



Wallwash C

H:320cm
Distance to the ceiling:80cm
Distance between fixtures:150cm



Wallwash D

H:320cm
Distance to the ceiling:80cm
Distance between fixtures:150cm

Light distribution

Wallwash A

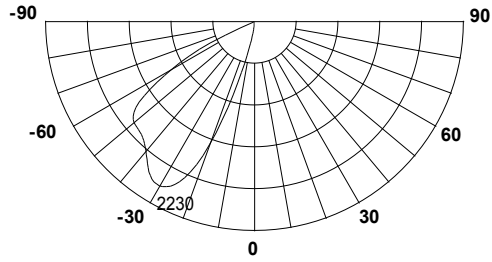
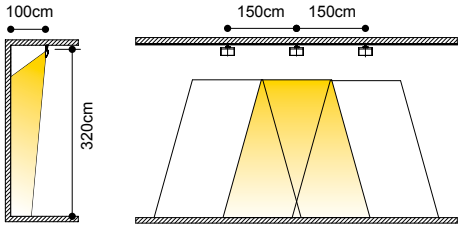

h (m)	D (m)	E (lx)
42°		
1.0	0.78	1444
2.0	1.56	361
3.0	2.35	190
4.0	3.13	60
5.0	3.91	57

Wallwash B

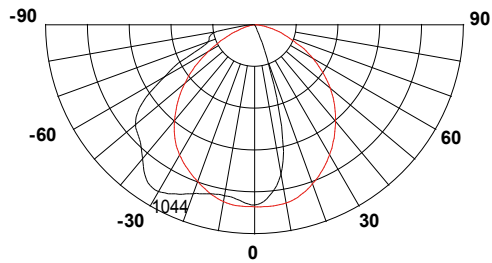
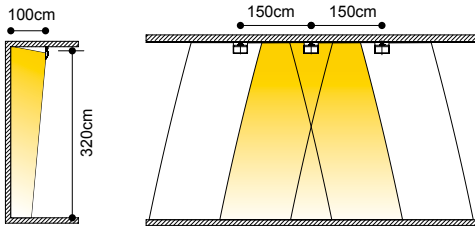

h (m)	D (m)	E (lx)
76°		
1.0	1.58	981
2.0	3.17	254
3.0	4.75	109
4.0	6.34	61
5.0	7.92	39

Wallwash C

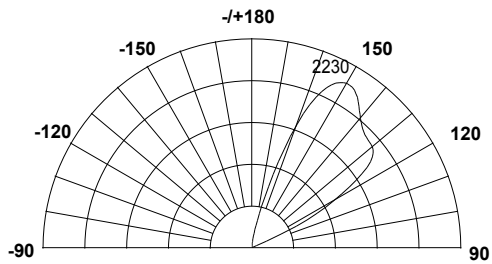
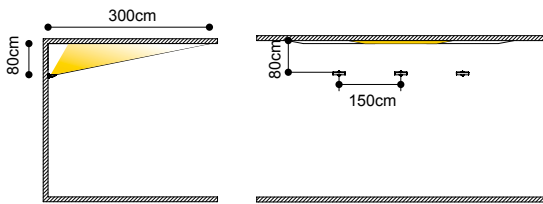

h (m)	D (m)	E (lx)
42°		
1.0	0.78	1444
2.0	1.56	361
3.0	2.35	190
4.0	3.13	60
5.0	3.91	57

Wallwash D

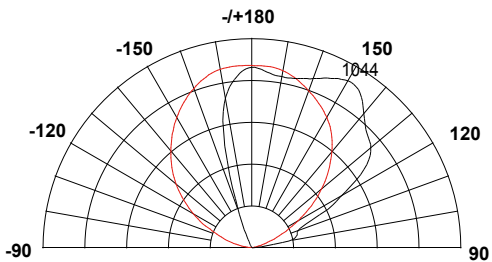
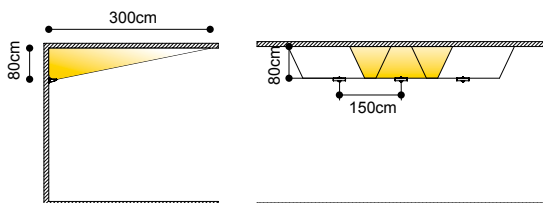

h (m)	D (m)	E (lx)
76°		
1.0	1.58	981
2.0	3.17	254
3.0	4.75	109
4.0	6.34	61
5.0	7.92	39

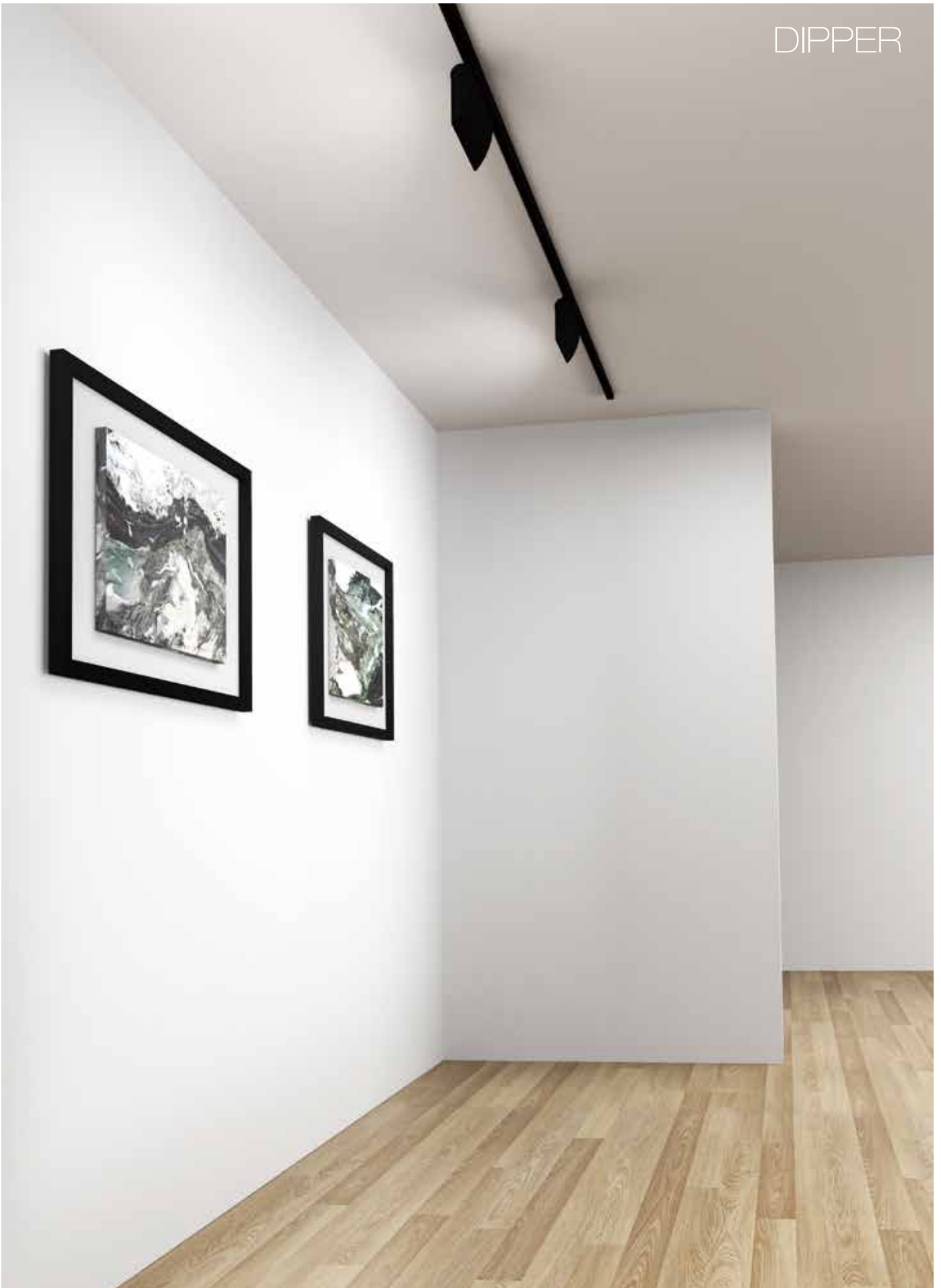



Article number	1619.101A
LED Consumption	35W
Voltage	220-240 (V AC)
System Lumen	2600+(lm)
Beam Angle	Wallwash A/B
CCT	3000K
CRI	90+

Driver Built-in

Colours  
Black White



Dimmable

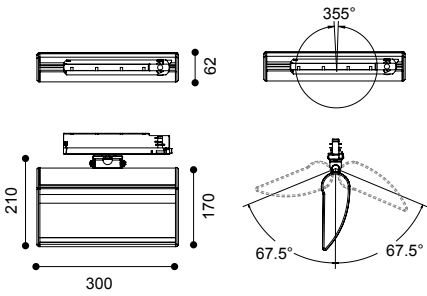

Article number	1619.101B
LED Consumption	30W
Voltage	220-240 (V AC)
System Lumen	1850+(lm)
Beam Angle	Wallwash A/B
CCT	3000K
CRI	90+

Driver Built-in

Colours  
Black White



Dimmable

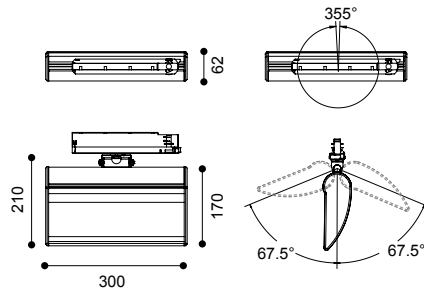

Article number	1919.200
LED Consumption	17W
Voltage	220-240 (V AC)
System Lumen	1000+(lm)
Beam Angle	Wallwash A/B
CCT	3000K
CRI	90+

Driver Built-in

Colours  
Black White



Dimmable

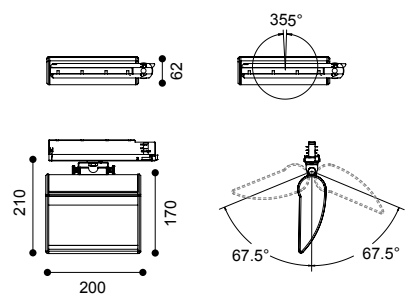
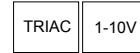





Article number	1619.302
LED Consumption	30W
Voltage	100-240 (V AC)
System Lumen	1850+(lm)
Beam Angle	Wallwash A/B
CCT	3000K
CRI	90+

Driver Built-in

Colours Black White

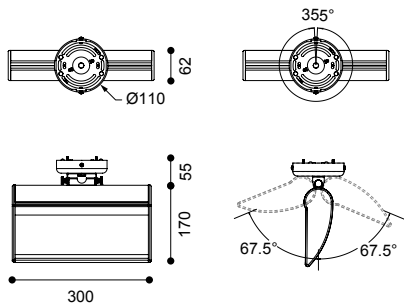

Article number	1615.101
LED Consumption	30W
Voltage	100-240 (V AC)
System Lumen	1850+(lm)
Beam Angle	Wallwash C/D
CCT	3000K
CRI	90+

Driver Built-in

Colours Black White

