



NOTOR

Material: Aluminum die casting or aluminum forging heatsink with anodized black or powder coating finish, aluminum die casting trim with powder coating finish.
Recessed pulled down lights, with different sizes and wattage available, it can tilt up to 90 degree and rotate up to 0~355 degree horizontally to highlight where to be the object focused as a right choice of spot light.





Article number	1518.302
LED Consumption	25.5W
Current	700 (mA)
Lumen	2670 (lm)
Beam Angle	12°/24°/40°
CCT	3000K
CRI	90+

Colours  
 Black White



Dimmable

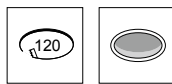
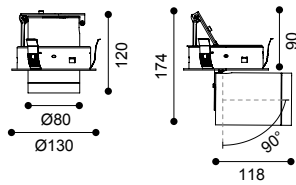

Article number	1518.301
LED Consumption	12.8W
Current	350 (mA)
Lumen	1387 (lm)
Beam Angle	20°/40°
CCT	3000K
CRI	90+

Colours  
 Black White



Dimmable

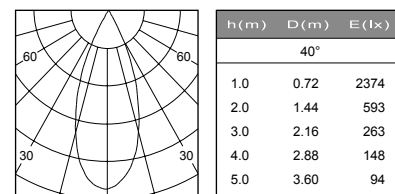
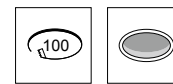
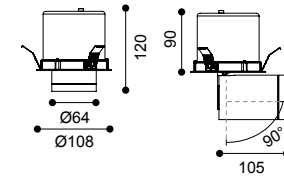



Article number	1268.102
LED Consumption	3W
Current	700 (mA)
Lumen	115 (lm)
Beam Angle	15°/36°/48°
CCT	3000K
CRI	90+

Colours  
 Black White



Dimmable

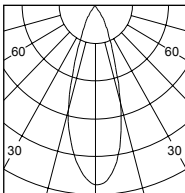
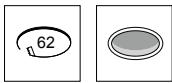
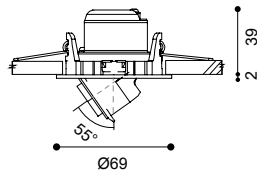

h (m)	D (m)	E (lx)
	36°	
1.0	0.58	381
2.0	1.16	95
3.0	1.74	42
4.0	2.32	23
5.0	2.90	15

Accessories



SG7-1
Striped glass

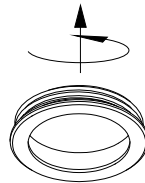
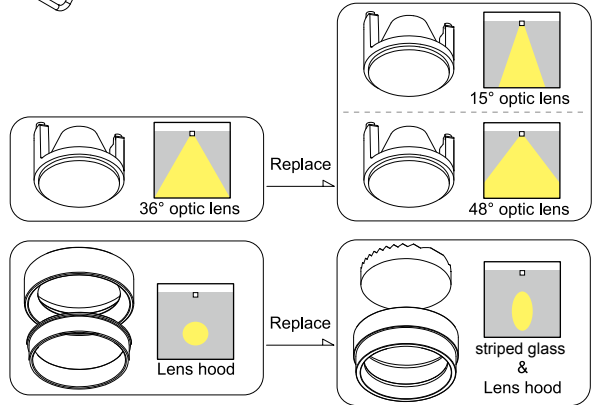
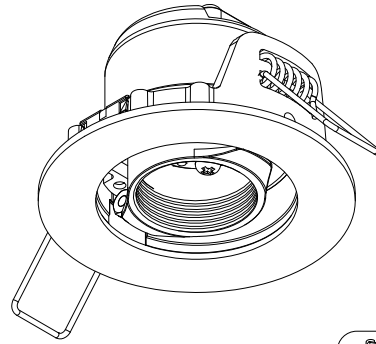



Article number	1568.100
LED Consumption	3W
Current	700 (mA)
Lumen	115 (lm)
Beam Angle	15°
CCT	3000K
CRI	90+

Colours  
Black White

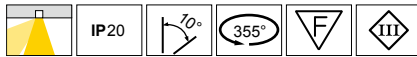

Dimmable

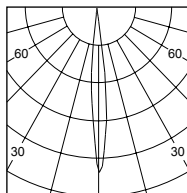
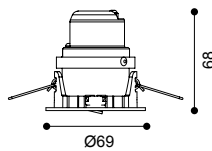

h (m)	D (m)	E (lx)
10°		
1.0	0.17	1461
2.0	0.35	365
3.0	0.52	162
4.0	0.70	91
5.0	0.88	58



Article number	1468.102
LED Consumption	3W
Current	700 (mA)
Lumen	115 (lm)
Beam Angle	15°
CCT	3000K
CRI	90+

Colours  
Black White



Dimmable

