

CABINET LIGHTS

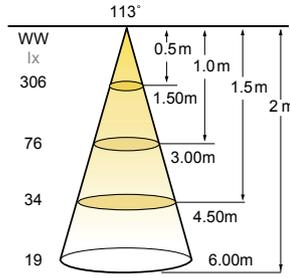

EGG 4W



Product specification and features

- The cabinet lights consists of aluminum and opal diffuser.
- Ultrs slim profile. Only 13mm of installation depth.
- It's low in power consumption yet deliveries impressive lighting performance.
- Easy installation with clips.
- It's innovative Led lighting design for under cabinet and showcase illumination.

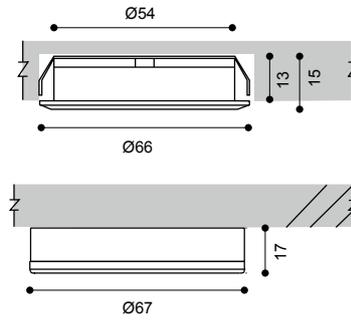
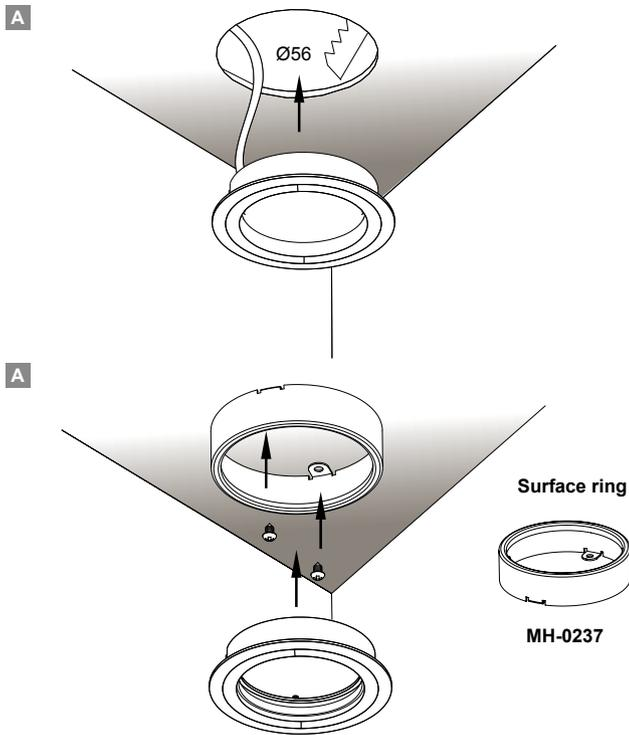

- Colours
- White
 - Silver
 - Satin Nickel
- (MH-0237)
- White
 - Satin Nickel

	Article number	LED Consumption	Voltage	System Lumen	Beam Angle	LED Type	LED q'ty	CCT/CRI
EGG 4W	1468.107	4W	12V DC	200 (lm)	113°	SMD	48	30/80+
	1468.107	4W	12V DC	220 (lm)	113°	SMD	48	40/80+
	1468.107A	4W	24V DC	200 (lm)	113°	SMD	48	30/80+
	1468.107A	4W	24V DC	220 (lm)	113°	SMD	48	40/80+



AKIS-R-II



BANIO-R-II

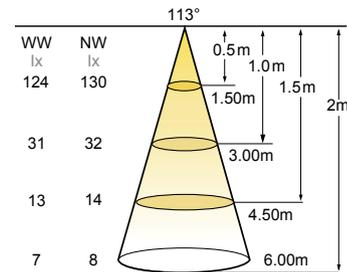

Product specification and features

- The cabinet lights consists of plastic fitting and optic lens.
- Ultra slim profile. Only 11mm of installation depth.
- It's low in power consumption yet delivers impressive lighting performance.
- Easy installation with clips.
- It's innovative Led lighting design under cabinet and showcase illumination.
- Color available : white / black / chrome / gold / matt chrome / satin

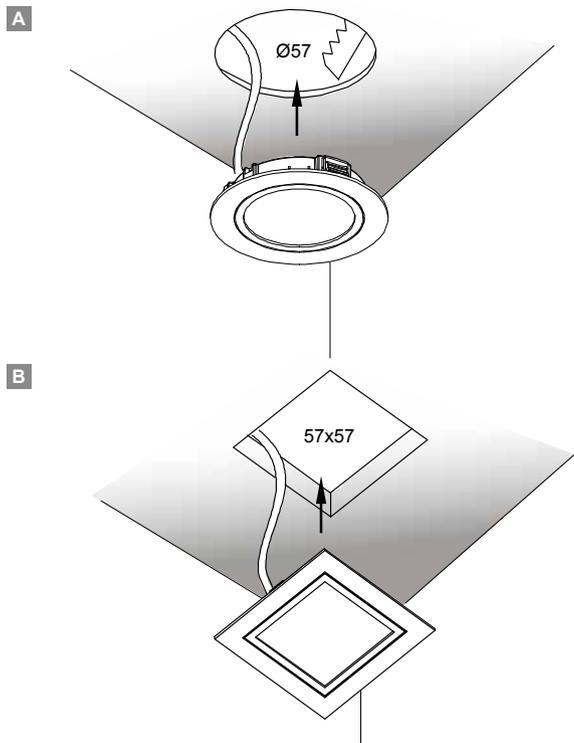

Surface ring

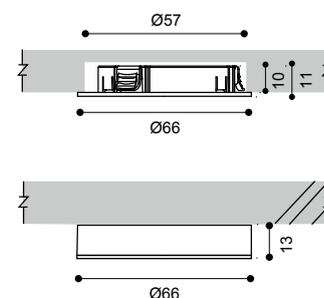
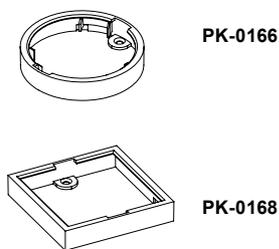

Colours
 Black White Chrome Gold Satin Matt chrome

	Article number	LED Consumption	Voltage	System Lumen	Beam Angle	LED Type	LED q'ty	CCT/CRI
AKIS-R-II	1468.106	1.7W	12V DC	100 (lm)	113°	SMD	48	30/80+
	1468.106	1.7W	12V DC	105 (lm)	113°	SMD	48	40/80+
	1468.106A	1.7W	24V DC	100 (lm)	113°	SMD	48	30/80+
	1468.106A	1.7W	24V DC	105 (lm)	113°	SMD	48	40/80+
AKIS-R-6-II	1468.111	1.44W	12V DC	90 (lm)	113°	SMD	6	30/80+
	1468.111	1.44W	12V DC	95 (lm)	113°	SMD	6	40/80+
BANIO-R-II	1468.113	1.7W	12V DC	100 (lm)	113°	SMD	48	30/80+
	1468.113	1.7W	12V DC	105 (lm)	113°	SMD	48	40/80+
	1468.113A	1.7W	24V DC	100 (lm)	113°	SMD	48	30/80+
	1468.113A	1.7W	24V DC	105 (lm)	113°	SMD	48	40/80+



ZURG-R



ZURG-S

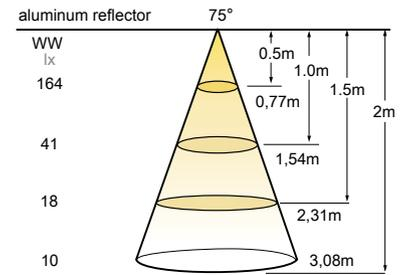
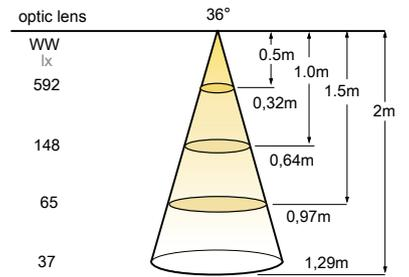

Product specification and features

- The cabinet lights consists of aluminum body and optic lens or aluminum reflector.
- The spotlight is designed with excellent heat sink.
- Optic lens and aluminum reflector replaceable easily for diverse application.
- Easy installation with clips.
- It's perfect design for under cabinet and showcase illumination.

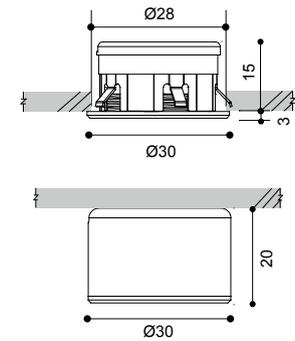
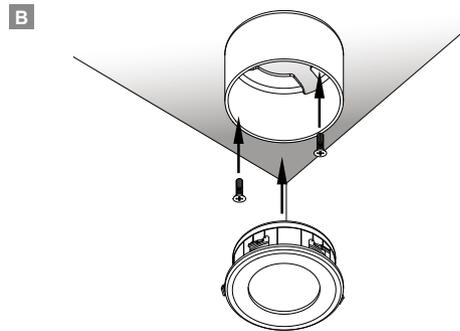
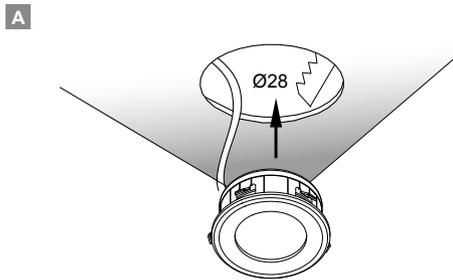

optic lens 36°

aluminum reflector 75°

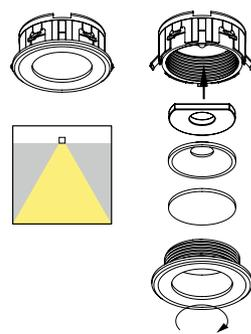
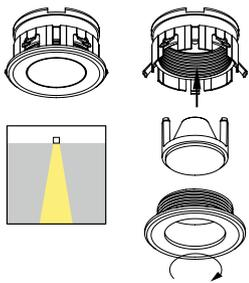

Colours  Satin Nickel

	Article number	LED Consumption	Current	Lumen	Beam Angle	LED Type	LED q'ty	CCT/CRI
ZURG-R	1268.104	1W	350mA	70 (lm)	36°/75°	HIGH POWER	1	30/80+
	1268.104	1W	350mA	105 (lm)	36°/75°	HIGH POWER	1	57/80+
ZURG-S	1263.104	1W	350mA	70 (lm)	36°/75°	HIGH POWER	1	30/80+
	1263.104	1W	350mA	105 (lm)	36°/75°	HIGH POWER	1	57/80+



STAR - UNIT



BARRA - UNIT

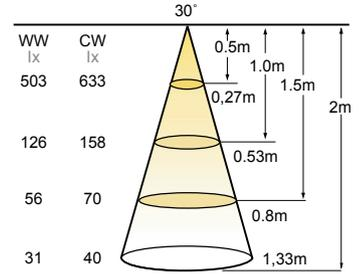

Product specification and features

- The cabinet lights consists of plastic fitting and optic lens.
- Ultra slim profile. Only 12mm of installation depth.
- It's low in power consumption yet delivers impressive lighting performance.
- Easy installation with clips.
- It's innovative Led lighting design under cabinet and showcase illumination.
- Color available : black / brushed satin / brushed gold

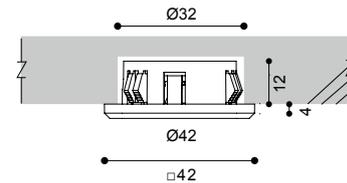
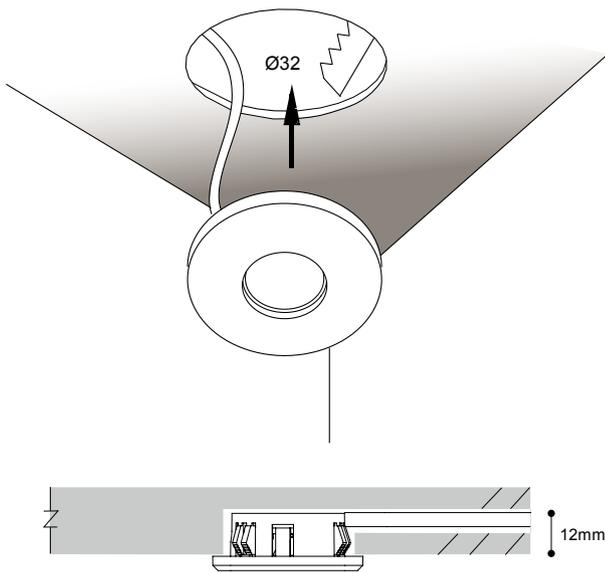

Colours   
Black Gold Satin Nickel

	Article number	LED Consumption	Current	Lumen	Beam Angle	LED Type	LED q'ty	CCT/CRI
STAR-UNIT	0968.128	1W	350mA	80 (lm)	30°	HIGH POWER	1	30/80+
	0968.128	1W	350mA	100 (lm)	30°	HIGH POWER	1	57/80+
BARRA-UNIT	0968.129	1W	350mA	80 (lm)	30°	HIGH POWER	1	30/80+
	0968.129	1W	350mA	100 (lm)	30°	HIGH POWER	1	57/80+



TOBEY-8D



TOBEY-8D9



TOBEY-8D6-S



Product specification and features

- The cabinet lights consists of aluminum base and plastic diffuser.
- Electronic touch sensor switch(TOBEY-8D6-S).
- It's low in power consumption yet delivers impressive lighting performance.
- Easy installation with screws.
- It's perfect design for under cabinet and showcase illumination.

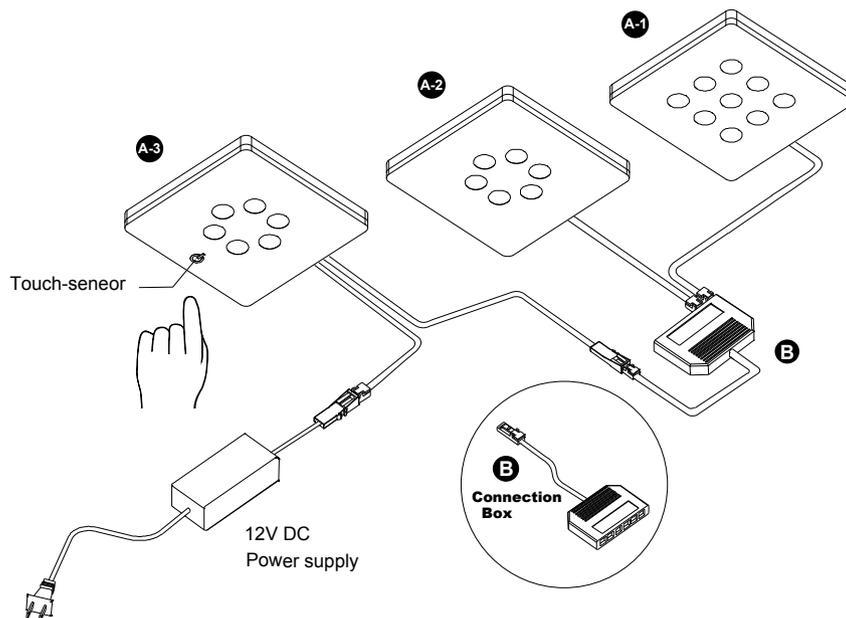
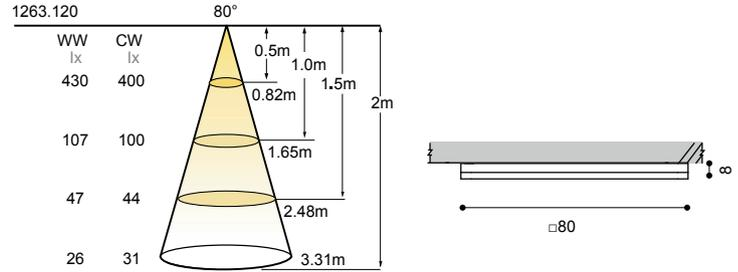

Colours
Black White

Article number	LED Consumption	Voltage	System Lumen	Beam Angle	LED Type	LED q'ty	CCT/CRI
A-1 TOBEY-8D9+	1263.120	3.6W	12V DC	165 (lm)	80°	SMD	9 30/80+
	1263.120	3.6W	12V DC	194 (lm)	80°	SMD	9 40/80+
A-2 TOBEY-8D6+	1263.119	2.4W	12V DC	113 (lm)	80°	SMD	6 30/80+
	1263.119	2.4W	12V DC	133 (lm)	80°	SMD	6 40/80+
	1263.119B	2.4W	24V DC	113 (lm)	80°	SMD	6 30/80+
	1263.119B	2.4W	24V DC	133 (lm)	80°	SMD	6 40/80+
A-3 TOBEY-8D6-S+	1263.119A	2.4W	12V DC	113 (lm)	80°	SMD	6 30/80+
	1263.119A	2.4W	12V DC	133 (lm)	80°	SMD	6 40/80+
	1263.119C	2.4W	24V DC	113 (lm)	80°	SMD	6 30/80+
	1263.119C	2.4W	24V DC	133 (lm)	80°	SMD	6 30/80+

Accessories

- B PC-0108P-MA TOP 3 way parallel cinnection
 PC-0109P-MA TOP 6 way parallel cinnection



TOBEY-C8D



TOBEY-C8D9



TOBEY-C8D6-S



Product specification and features

- The cabinet lights consists of aluminum base and plastic diffuser.
- Electronic touch sensor switch(TOBEY-C8D6-S+).
- It's low in power consumption yet deliveries impressive lighting performance.
- Easy installation with screws.
- It's perfect design for under cabinet and showcase illumination.

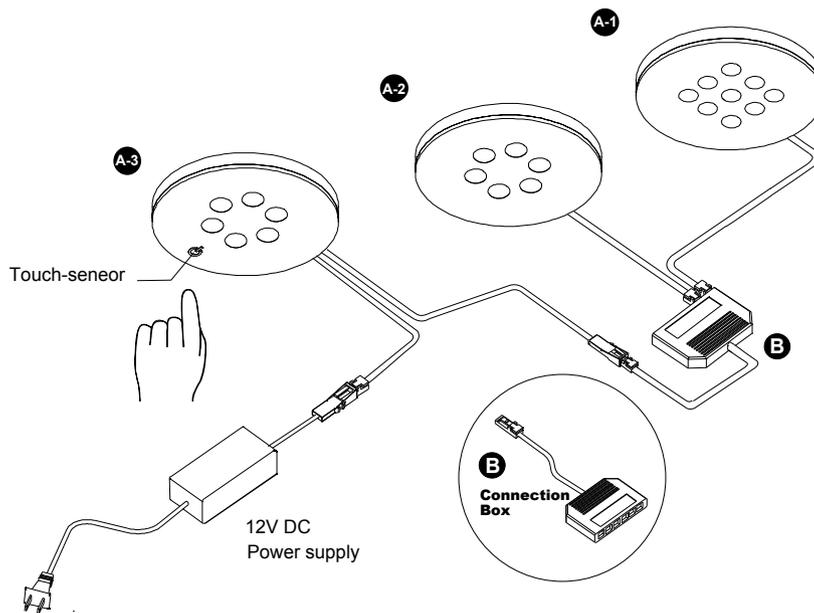
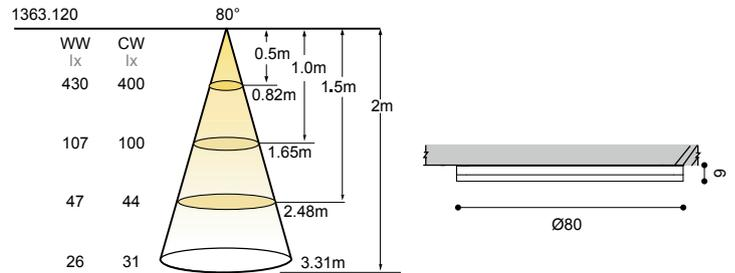

Colours ● ○
Black White

	Article number	LED Consumption	Voltage	System Lumen	Beam Angle	LED Type	LED q'ty	CCT/CRI	
A-1	TOBEY-C8D9+	1363.120	3.6W	12V DC	165 (lm)	80°	SMD	9	30/80+
		1363.120	3.6W	12V DC	194 (lm)	80°	SMD	9	40/80+
A-2	TOBEY-C8D6+	1363.119	2.4W	12V DC	113 (lm)	80°	SMD	6	30/80+
		1363.119	2.4W	12V DC	133 (lm)	80°	SMD	6	40/80+
		1363.119B	2.4W	24V DC	113 (lm)	80°	SMD	6	30/80+
		1363.119B	2.4W	24V DC	133 (lm)	80°	SMD	6	40/80+
A-3	TOBEY-C8D6-S+	1363.119A	2.4W	12V DC	113 (lm)	80°	SMD	6	30/80+
		1363.119A	2.4W	12V DC	133 (lm)	80°	SMD	6	40/80+
		1363.119C	2.4W	24V DC	113 (lm)	80°	SMD	6	30/80+
		1363.119C	2.4W	24V DC	133 (lm)	80°	SMD	6	30/80+

Accessories

B	PC-0108P-MA	TOP 3 way parallel connection
	PC-0109P-MA	TOP 6 way parallel connection



TOBEY-16L18

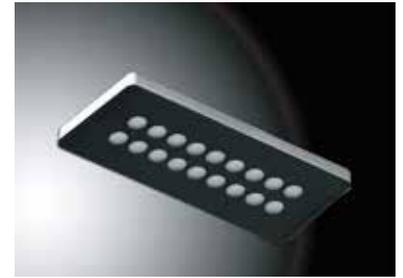

Product specification and features

- The cabinet lights consists of aluminum base and plastic diffuser.
- It's low in power consumption yet deliveries impressive lighting performance.
- Easy installation with screws.
- It's perfect design for under cabinet and showcase illumination.

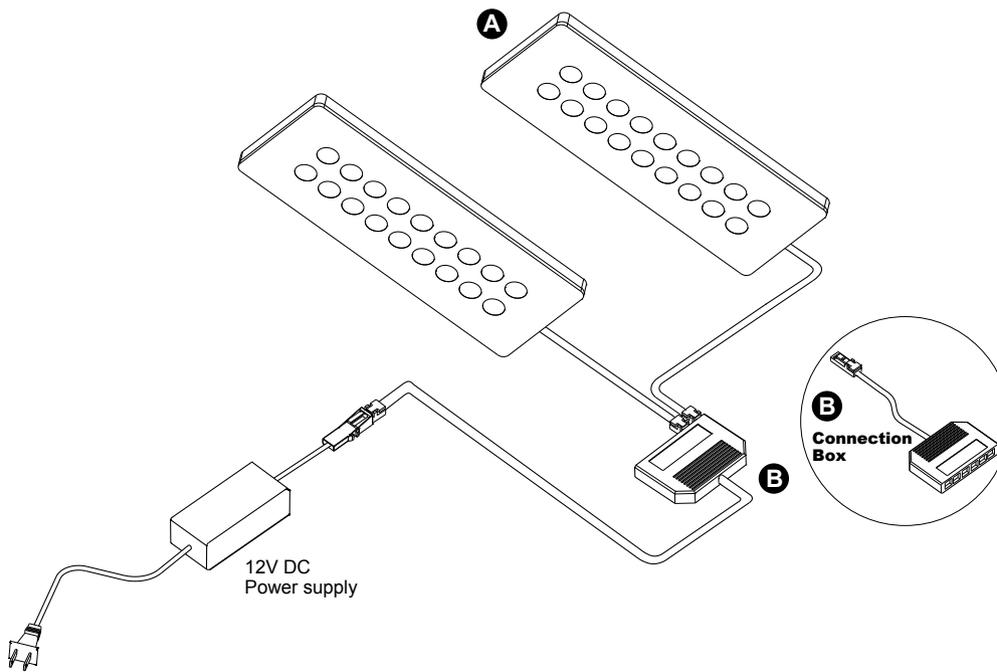
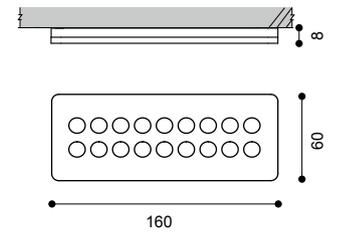
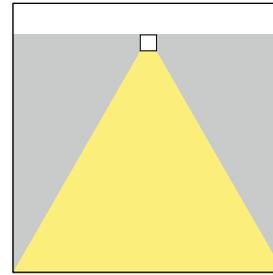

Colours Black White

	Article number	LED Consumption	Voltage	System Lumen	Beam Angle	LED Type	LED q'ty	CCT/CRI
A-1	TOBEY-16L18	1363.109	4.3W	12V DC	210 (lm)	80°	18	30/80+
		1363.109	4.3W	12V DC	249 (lm)	80°	18	40/80+

Accessories

B	PC-0108P-MA	TOP 3 way parallel connection
	PC-0109P-MA	TOP 6 way parallel connection



TOBEY-WCW



TOBEY-WCW-8D9



TOBEY-WCW-8D6



Product specification and features

- The cabinet lights consists of aluminum base and plastic diffuser.
- It's low in power consumption yet deliveries impressive lighting performance.
- Easy installation with screws.
- It's perfect design for under cabinet and showcase illumination.

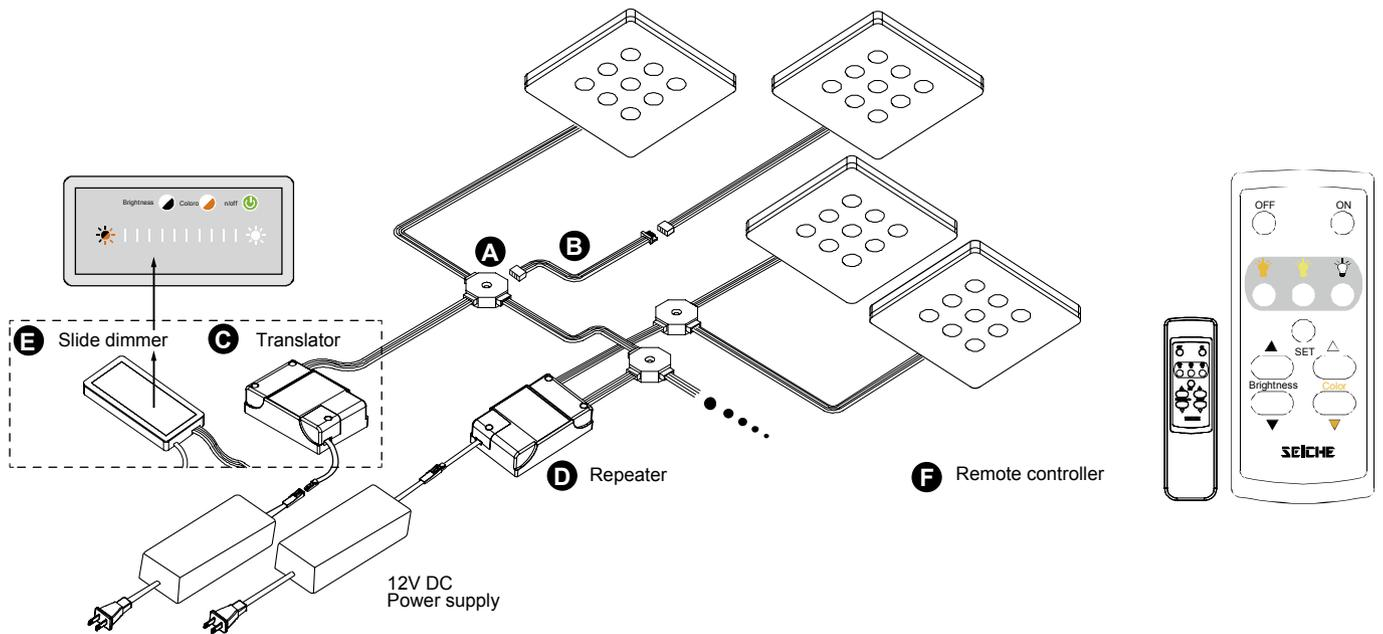
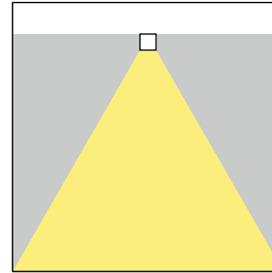

Colours ● Black ○ White

	Article number	LED Consumption	Voltage	System Lumen	Beam Angle	LED Type	LED q'ty	CCT/CRI	
A-1	TOBEY-WCW-8D9	1363.101	3.6W	12V DC	165 (lm)	80°	SMD	18	30-65/80+
A-2	TOBEY-WCW-8D6	1363.102	2.4W	12V DC	113 (lm)	80°	SMD	12	30-65/80+

Accessories

A	PC-1052P	Molex 4pin junction box(3 way parallel)
B	CS-16-25	molex 4pin male & female 25cm connector
	CS-16-50	Molex 4pin male & female 50cm connector
C	8105	12V DC brightness and color temperature translator
D	9105	12V DC brightness and color temperature repeater
E	ES-0046	Brightness and color temperature slide dimmer
F	801	Remote controller



TOBEY-16L9



TOBEY-16L9



TOBEY-16L9-S



Product specification and features

- The cabinet lights consists of aluminum base and plastic diffuser.
- Electronic touch sensor switch(TOBEY-16L9-S).
- It's low in power consumption yet deliveries impressive lighting performance.
- Easy installation with screws.
- It's perfect design for under cabinet and showcase illumination.

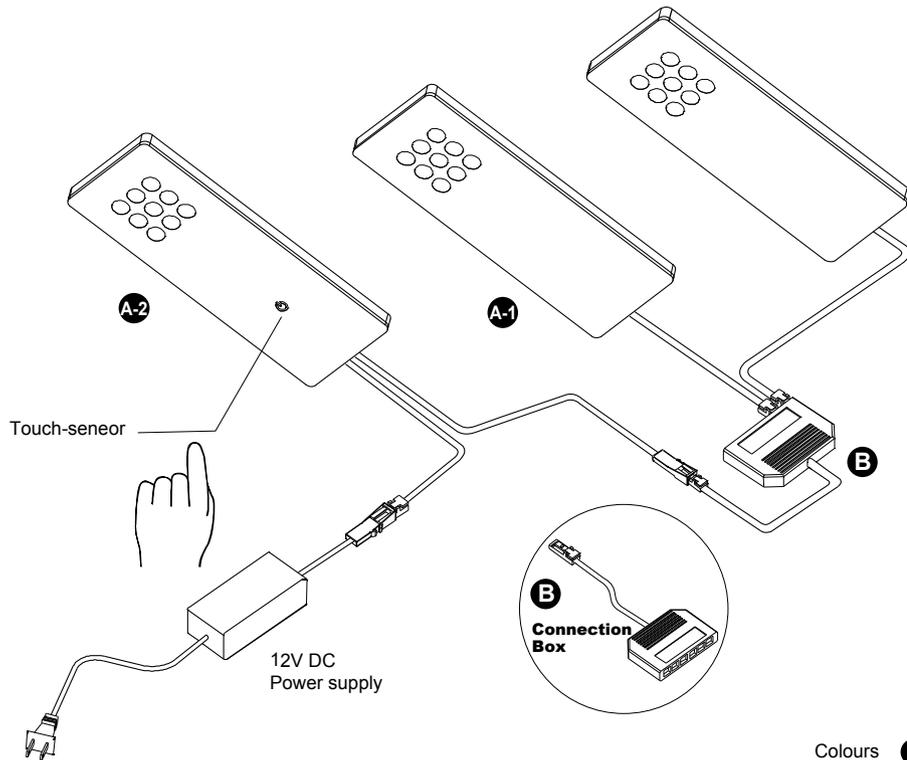
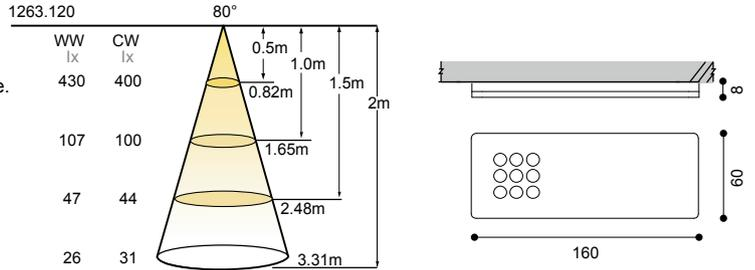

Colours ● ○
Black White

	Article number	LED Consumption	Voltage	System Lumen	Beam Angle	LED Type	LED q'ty	CCT/CRI	
A-1	TOBEY-16L9+	1263.111	3.6W	12V DC	165 (lm)	80°	SMD	9	30/80+
		1263.111	3.6W	12V DC	194 (lm)	80°	SMD	9	40/80+
A-2	TOBEY-16L9-S+	1263.112	3.6W	12V DC	165 (lm)	80°	SMD	9	30/80+
		1263.112	3.6W	12V DC	194 (lm)	80°	SMD	9	40/80+

Accessories

B	PC-0108P-MA	TOP 3 way parallel cinnection
	PC-0109P-MA	TOP 6 way parallel cinnection

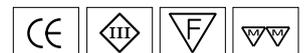

GRACE



GRACE



GRACE-SENSOR

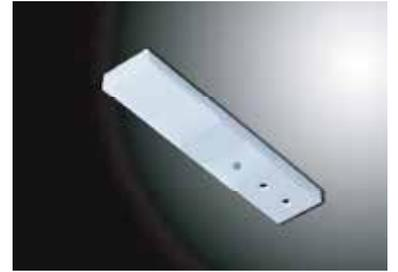

Product specification and features

- The cabinet lights consists of aluminum extruded body ,acrylic diffuser and ABS end cap.
- Electronic Led touch sensor switch.
- Ultra slim profile.
- Easy intallation with screws.
- It's innovation design for under cabinet and over cabinet illumination.

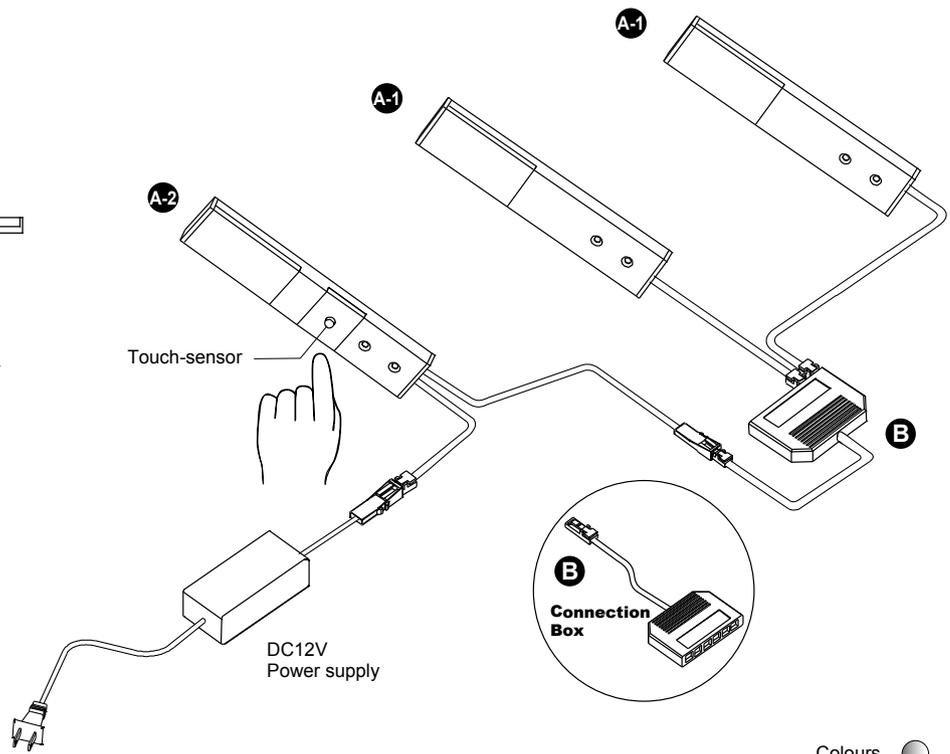
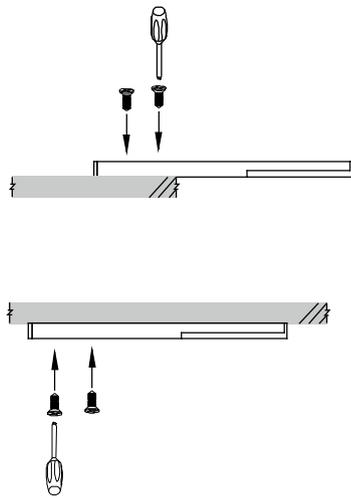
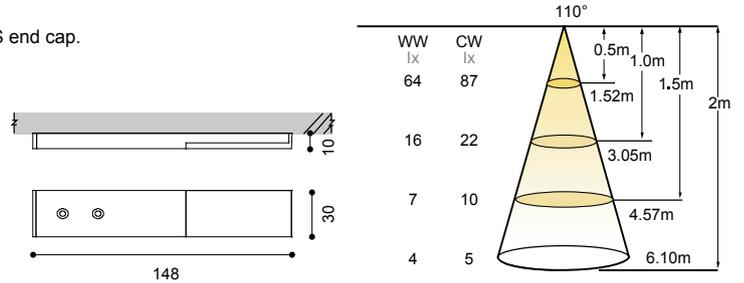

Colours  Anodized alum.

	Article number	LED Consumption	Voltage	System Lumen	Beam Angle	LED Type	LED q'ty	CCT/CRI
A-1	0860.020	2.2W	12V DC	118 (lm)	110°	SMD	9	30/80+
	0860.020	2.2W	12V DC	138 (lm)	110°	SMD	9	40/80+
A-2	0860.018	2.2W	12V DC	118 (lm)	110°	SMD	9	30/80+
	0860.018	2.2W	12V DC	138 (lm)	110°	SMD	9	40/80+

Accessories

B	PC-0108P-MA	TOP3 way parallel connection
	PC-0109P-MA	TOP6 way parallel connection



TEMPO-B



SOUL-B



Product specification and features

- The cabinet lights consists of zinc die casting aluminum front bezel , steel backplate.
- Ultra slim profile
- Front bezel installation by parallel / rotation sliding.
- Easy installation with screws.
- It's perfect design for under cabinet and showcase illumination.

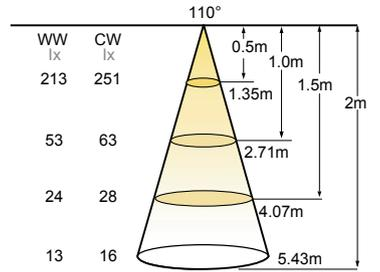

A-1

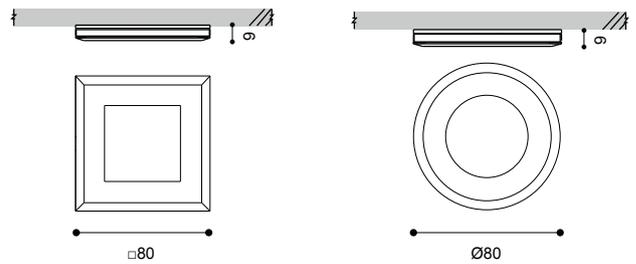
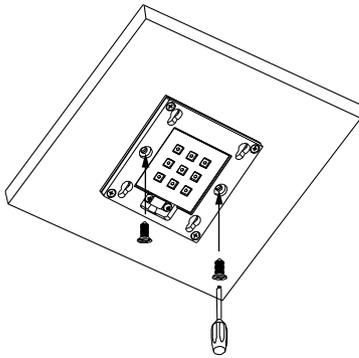

A-2

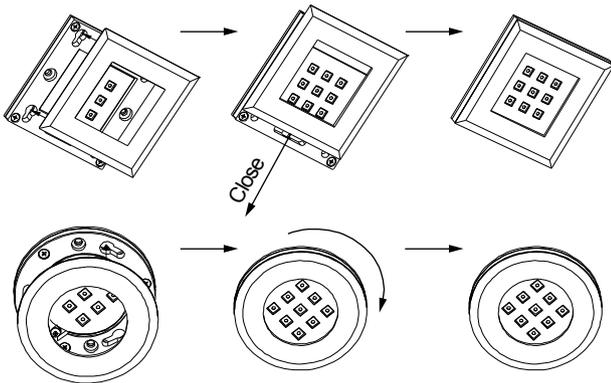

Colours Chrome

	Article number	LED Consumption	Voltage	System Lumen	Beam Angle	LED Type	LED q'ty	CCT/CRI
TEMPO-B+	1263.101	3.6W	12V DC	189 (lm)	110°	SMD	9	30/80+
	1263.101	3.6W	12V DC	230 (lm)	110°	SMD	9	40/80+
SOUL-B+	1263.102	3.6W	12V DC	189 (lm)	110°	SMD	9	30/80+
	1263.102	3.6W	12V DC	230 (lm)	110°	SMD	9	40/80+



TEMPO-S

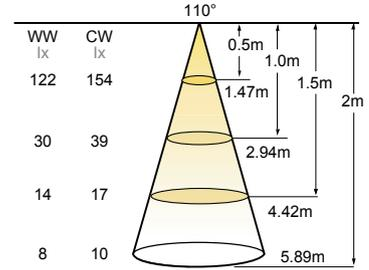
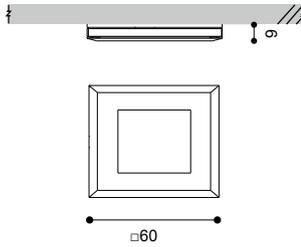

Product specification and features

- The cabinet lights consists of zinc die casting aluminum front bezel , steel backplate and acrylic diffuser.
- Ultra slim profile.
- Front bezel installation by parallel sliding.
- Easy installation with screws.
- It's perfect design for under cabinet and showcase illumination.

Colours  Chrome

	Article number	LED Consumption	Voltage	Lumen	Beam Angle	LED Type	LED q'ty	CCT/CRI
TEMPO-S+	1263.103	2.4W	12V DC	127 (lm)	110°	SMD	6	30/80+
	1263.103	2.4W	12V DC	155 (lm)	110°	SMD	6	40/80+



SOUL-S

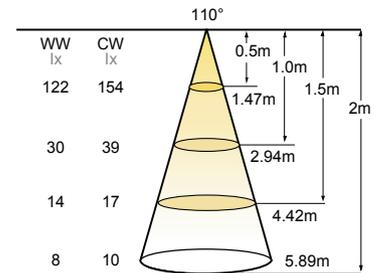
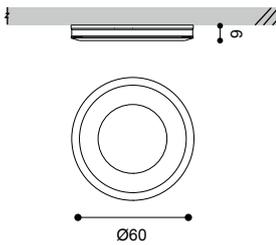

Product specification and features

- The spotlight consists of zinc die casting aluminum front bezel , steel backplate and acrylic diffuser.
- Ultra slim profile.
- Front bezel installation by parallel sliding.
- Easy installation with screws.
- It's perfect design for under cabinet and showcase illumination.

Colours  Chrome

	Article number	LED Consumption	Voltage	System Lumen	Beam Angle	LED Type	LED q'ty	CCT/CRI
SOUL-S+	1263.117	2.4W	12V DC	127 (lm)	110°	SMD	6	30/80+
	1263.117	2.4W	12V DC	155 (lm)	110°	SMD	6	40/80+



IR SENSOR SWITCH

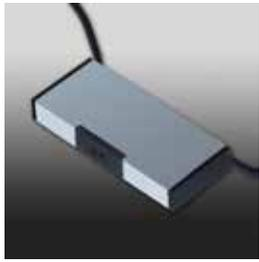

ES-0016-DC

- Electronic IR sensor, open / close door switch.
- Wattage : 12V DC / max 30W, 24V DC / max 60W.
- Rated input power : 12V DC, 24V DC.
- Detection range: max 7cm (detection range will vary when material & finish color are different).
- Can connect with LED converter to support constant current fixture.

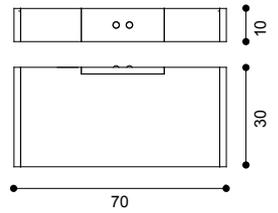

ES-0015-DC

- Electronic touch sensor switch.
- Wattage : max 30W.
- Rated input voltage : 12V DC, 24V DC.
- Can connect with LED converter to support constant current fixture.

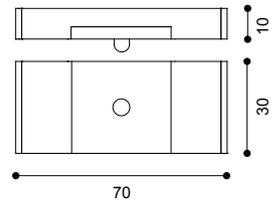

ES-0043-DC

- Electronic IR sensor switch.
- With both open / close door switch and object over sensor function.
- Wattage : 12V DC / max 30W, 24V DC / max 60W.
- Rated input voltage : 12V DC, 24V DC.
- Detection range: max 7cm (detection range will vary when material & finish color are different)
- Can connect with LED converter to support constant current fixture.

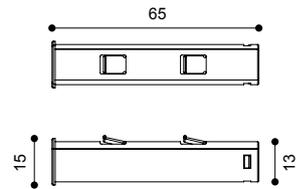

Open door to
switch on the light

Close door to
switch off the light



Object over the sensor
to switch on/off the light

With build-in digital filter to percolate
sun light / flash light / other infrared
remote control to avoid interfere.



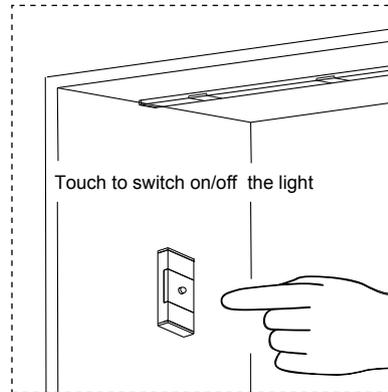
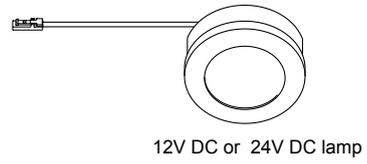
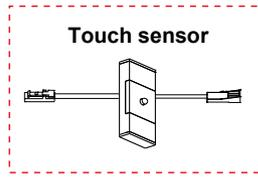
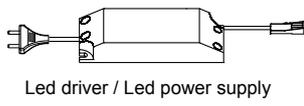

Surface mount

Recessed

Surface mount

Recessed

