



BROWNIE 40 (EU) system



BROWNIE 40 (EU)

Creativity in linear style

Innovative slim linear connecting system, a perfect combination between tracks and LED modules.

Not only emphasizing on characteristics and rapid installation of the modules, also creates simple and clean appearance.

Unique designed downlight, spot, panel and pendant modules are available for multitasking lighting requirement to the area.

This is a perfect solution to maximize lighting creativity.

BROWNIE 40 (EU)

BROWNIE 40 TRACK



BNT-01



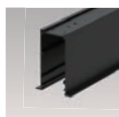













Surface / Pendant Track



BNF-01

Recessed Track

BROWNIE 40 MODULES

		Series name	LED Consumption	Lumen
		BROWNIE 40-P	9.4W 19.8W	784 (lm) 1568 (lm)
		BROWNIE 40-P	4W 6W 7.6W	344 (lm) 523 (lm) 604 (lm)
		BROWNIE 40-W	23W	1870 (lm)
		BROWNIE 40-F	1W X6	463 (lm)
		BROWNIE 40-G	5W X2	768 (lm)
		BROWNIE 40-S	7W 7W X2 13W 13W X2	567 (lm) 1147 (lm) 1172 (lm) 2376 (lm)
		BROWNIE 40-C	7W 13W 20W	437 (lm) 951 (lm) 1666 (lm)
		BROWNIE 40-LC	25W	2112 (lm)

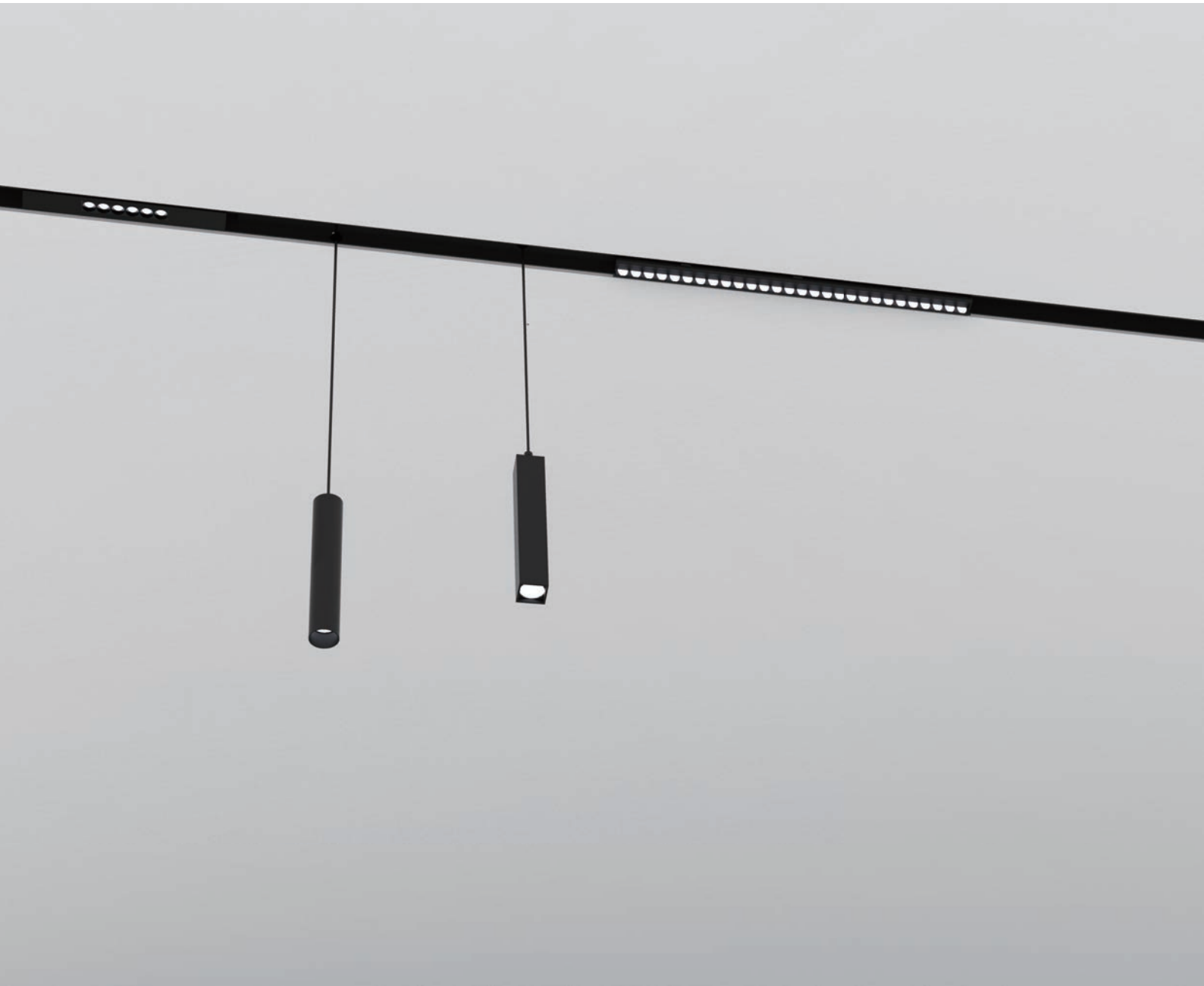

BROWNIE 40 (EU)

linear connecting system, can be recessed (trimless), surface mount-ed or pendant. Suitable for all kinds of interior environment. The LED modules are designed with simple linear style, each series perform its own function, making lighting design easier than ever.

BROWNIE 40 (EU)

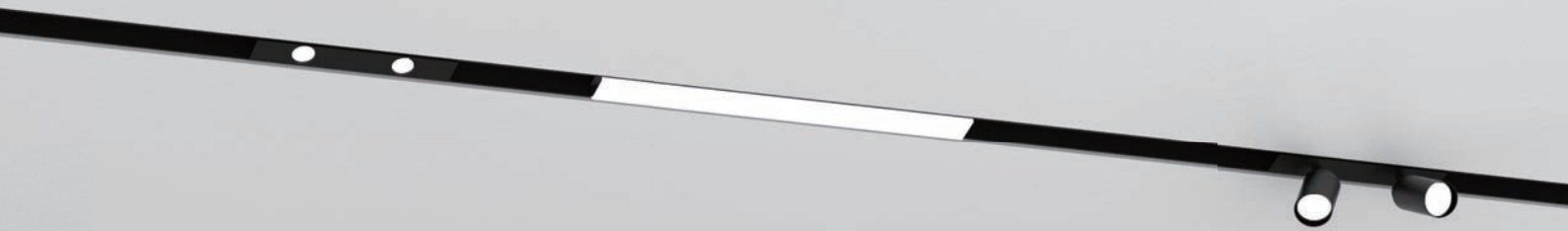

Recessed

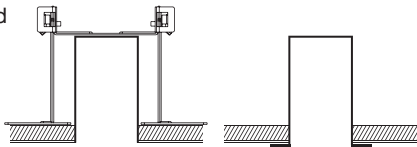

Surface mounted

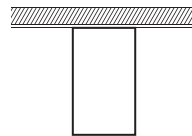

Pendant

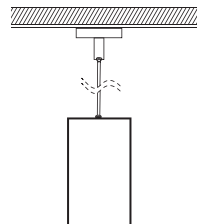



Quickinfo

GENERAL

Recessed

Pendant

Surface mounted

ELECTRICAL

0-10V

PHYSICAL

Aluminium

Spray powder

Description

With the ingenious mechanics, BROWNIE 40 brings a new picture to display lighting solutions for both pendant & surface mounted system.

The system can add different kind of the lighting module you want and offering a harmonious visual expert experience.

Panel



Pendant

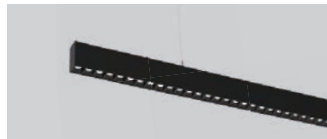

Fixed



Wallwash

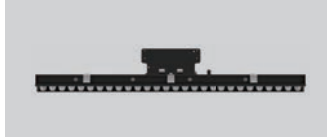

Spot



BROWNIE 40

order installation track, light insets+ mounting accessories separately

Colour Black ■ White □

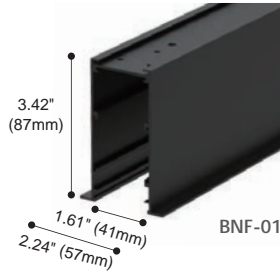
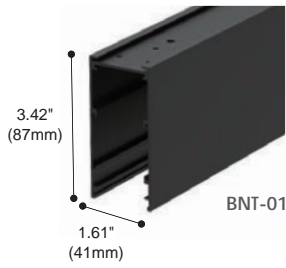

TRACK SECTION

Article number	L (mm)	TYPE
BNT-01-44	44.57"(1132mm)	Channel
BNT-01-89	89.13"(2264mm)	Channel
BNF-01-44	44.57"(1132mm)	Channel
BNF-01-89	89.13"(2264mm)	Channel

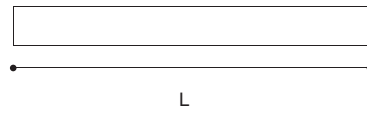

Accessories

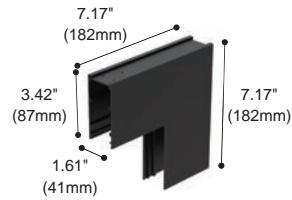

Article number: BNT-03
Type : 7 Type vertical corner

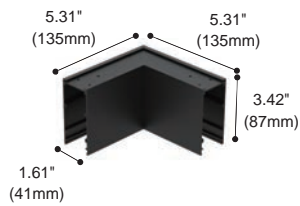

Article number: BNT-02
Type : L Type horizontal connector

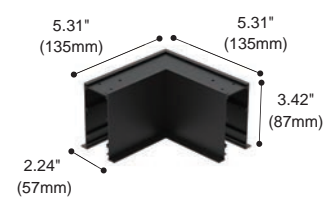

Article number: BNF-02
Type : L Type trim horizontal connector

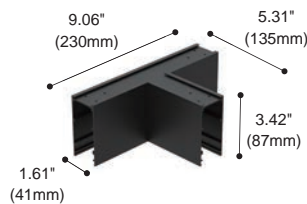

Article number: BNT-04
Type : T Type horizontal connector

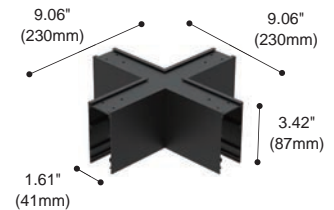

Article number: BNT-05
Type : X Type horizontal connector

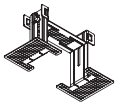

2PCS

Article number: BNR-02
Type : Trimless bracket

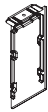

2PCS

Article number: BNC-01
Type : End cap

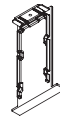

2PCS

Article number: BNC-04
Type : Trim end cap

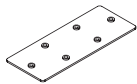

3PCS

Article number: BNC-02
Type : Surface mounted &
Pendant reinforced plate

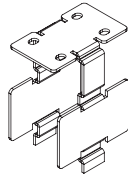

Article number: BNC-06
Type : Light Leak-proof aluminium
extrusion reinforce plate



Colours  
Black White

Article number:
BNE-01-11 11.14"(283mm)
BNE-01-22 22.28"(566mm)
Type : Blank cover

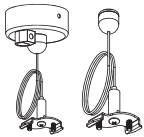

Article number: SDI-22
Type : Pendant Kit
for power connection
(without power cord)

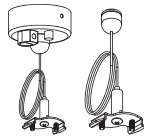

Article number: SDI-22-V
Type : Pendant Kit
for power connection
(without power cord
and signal wire)



Article number: SDI-16
Type : Pendant kit

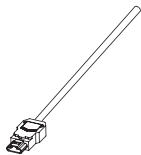

Models : CPE-41-180 71" (1800mm)
Type : Power cord connect to AC

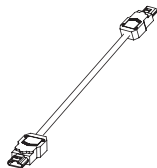

Models : CSE-41-30 12" (300mm)
CSE-41-60 24" (600mm)
Type : Power cord connect
between modules

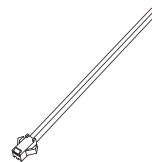

Models : CPSE-31-180 71" (1800mm)
Type : Signal wire connect
to system / dimmer

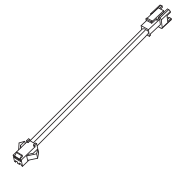

Models : CSSE-31-30 12" (300mm)
CSSE-31-60 24" (600mm)
Type : Signal wire connect
between modules



CHARACTERISTIC

- Modularization and diversity connectors are designed for easy connecting diversity tracks and help to maximize creativity in linear style.
- Track is designed to hide both module & linear driver for elegant appearance.
- Applicable with 0.75mm² power cable, 220-240VAC /5A
- IP20

BROWNIE 40 TRACK EXTRUSION





BROWNIE 40-P



P12

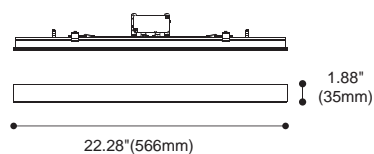

P24

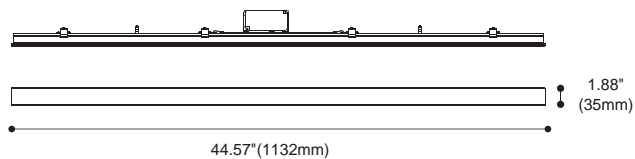

Product performance

BROWNIE 40-P12

Article number	LED Consumption	Voltage	Delivered Lumen	Beam Angle	CCT/CRI
2117.402A-V	9.4W	120-277VAC	784 (lm)	100°	30/90+

BROWNIE 40-P24

Article number	LED Consumption	Voltage	Delivered Lumen	Beam Angle	CCT/CRI
2117.402B-V	19.8W	120-277VAC	1568 (lm)	100°	30/90+





BROWNIE 40-P

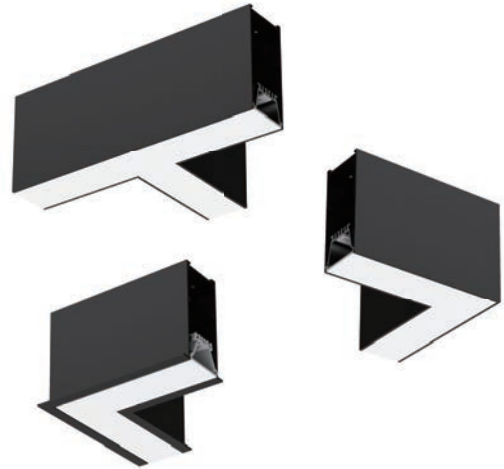

T Type

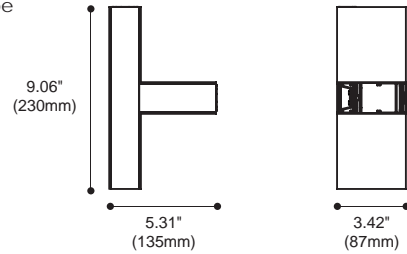

L Type

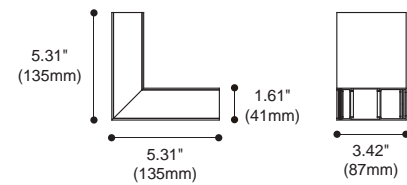

L Type trim

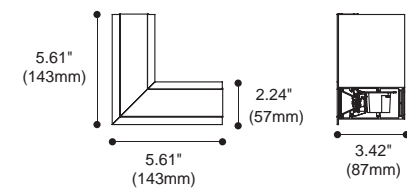

Colours Black White

Product performance

BROWNIE 40-PT Type

Article number	LED Consumption	Voltage	Delivered Lumen	Beam Angle	CCT/CRI
2117.417-V	6W	120-277VAC	523 (lm)	100°	30/90+

BROWNIE 40-PL Type

Article number	LED Consumption	Voltage	Delivered Lumen	Beam Angle	CCT/CRI
2117.416-V	4W	120-277VAC	344(lm)	100°	30/90+

BROWNIE 40-PL Type trim

Article number	LED Consumption	Voltage	Delivered Lumen	Beam Angle	CCT/CRI
2117.468-V	4W	120-277VAC	344 (lm)	100°	30/90+





BROWNIE 40-P



7 Type

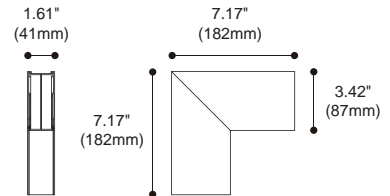

X Type

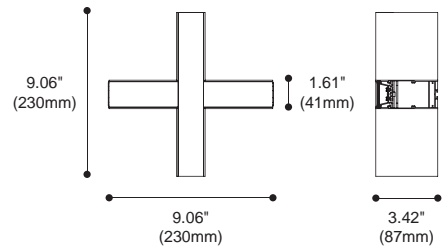

Colours Black White

Product performance

BROWNIE 40-P7 Type

Article number	LED Consumption	Voltage	Delivered Lumen	Beam Angle	CCT/CRI
2117.419-V	4W	120-277VAC	344 (lm)	100°	30/90+

BROWNIE 40-PX Type

Article number	LED Consumption	Voltage	Delivered Lumen	Beam Angle	CCT/CRI
2117.418-V	10W	120-277VAC	604 (lm)	100°	30/90+





BROWNIE 40-W

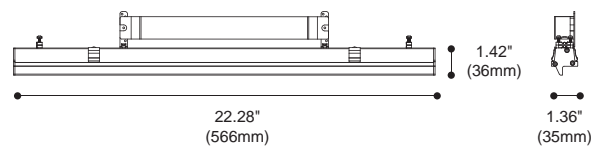

Colours Black White

Product performance

BROWNIE 40-W

Article number	LED Consumption	Voltage	Delivered Lumen	Beam Angle	CCT/CRI
2117.403-28-V	23W	120-277VAC	1870 (lm)	55° (Reflector)	30/90+



BROWNIE 40-F

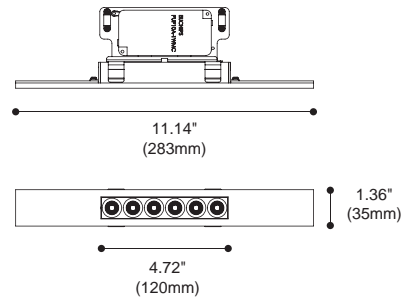

- Colours
 Black White
- Baffle :
 Black White Chrome Gold

Product performance

BROWNIE 40-F

Article number	LED Consumption	Voltage	Delivered Lumen	Beam Angle	CCT/CRI
2117.404-6-V	1W X6	120-277VAC	463 (lm)	25°/50° (Reflector)	30/90+



BROWNIE 40-G

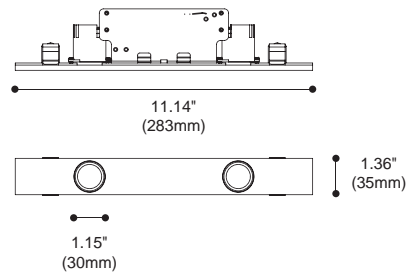

- Colours Black White
- Baffle : Black White

Product performance

BROWNIE 40-G

Article number	LED Consumption	Voltage	Delivered Lumen	Beam Angle	CCT/CRI
2117.411-V	5W X2	120-277VAC	768 (lm)	25°/40°/50° (Reflector)	30/90+





BROWNIE 40-S

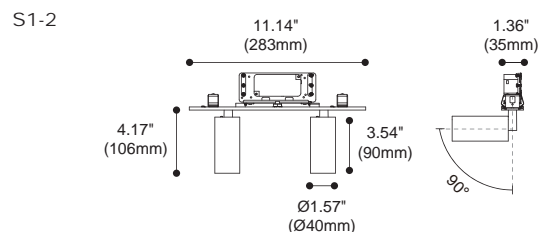
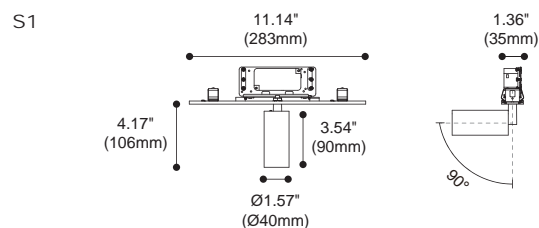

Accessories



ACSN-11 Long baffle ACSG-9 Striped glass ACWG-10 Woven glass ACDS-8 Diffusion sheet ACHO-13 Honeycomb louver

- Colours
 Black White
- Baffle :
 Black White Copper

Product performance

BROWNIE 40-S1

Article number	LED Consumption	Voltage	Delivered Lumen	Beam Angle	CCT/CRI
2117.405-V	7W	120-277VAC	567 (lm)	20°/25°/36° (Lens)	30/90+

BROWNIE 40-S1-2

Article number	LED Consumption	Voltage	Delivered Lumen	Beam Angle	CCT/CRI
2117.408-V	7W X2	120-277VAC	1147 (lm)	20°/25°/36° (Lens)	30/90+





BROWNIE 40-S



S2

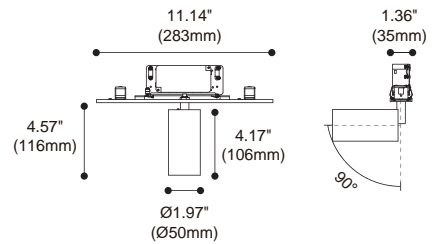

S2-2

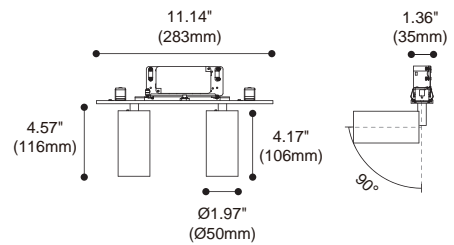

Accessories



ACSN-12
Long baffle



ACSG-10
Striped glass



ACWG-11
Woven glass



ACDS-9
Diffusion sheet

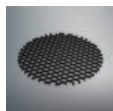

ACHO-14
Honeycomb
louver

- Colours
 Black White
- Baffle :
 Black White Copper

Product performance

BROWNIE 40-S2

Article number	LED Consumption	Voltage	Delivered Lumen	Beam Angle	CCT/CRI
2117.406-V	13W	120-277VAC	1172 (lm)	20°/30°/40° (Lens)	30/90+

BROWNIE 40-S2-2

Article number	LED Consumption	Voltage	Delivered Lumen	Beam Angle	CCT/CRI
2117.409-V	13W X2	120-277VAC	2376 (lm)	20°/30°/40° (Lens)	30/90+





BROWNIE 40-C

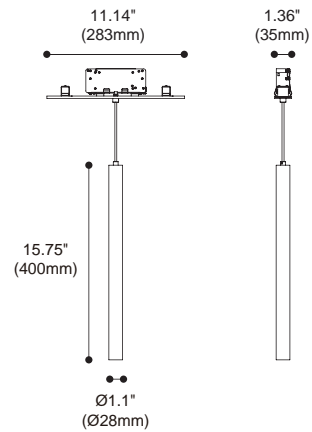

- Colours
- Black
 - White
- Baffle :
- Black
 - White
 - Copper

Product performance

BROWNIE 40-C5

Article number	LED Consumption	Voltage	Delivered Lumen	Beam Angle	CCT/CRI
2117.450-V	7W	120-277VAC	437 (lm)	30° (Lens)	30/90+

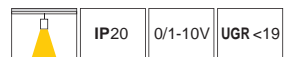



BROWNIE 40-C

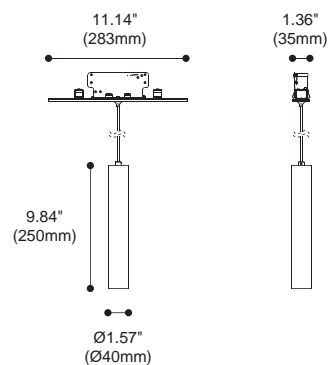

- Colours
 Black White
- Baffle :
 Black White Copper

Product performance

BROWNIE 40-C1

Article number	LED Consumption	Voltage	Delivered Lumen	Beam Angle	CCT/CRI
2117.412-V	7W	120-277VAC	557 (lm)	20°/25°/36° (Lens)	30/90+

BROWNIE 40-C2

Article number	LED Consumption	Voltage	Delivered Lumen	Beam Angle	CCT/CRI
2117.413-V	13W	120-277VAC	951 (lm)	20°/25°/36° (Lens)	30/90+





BROWNIE 40-C

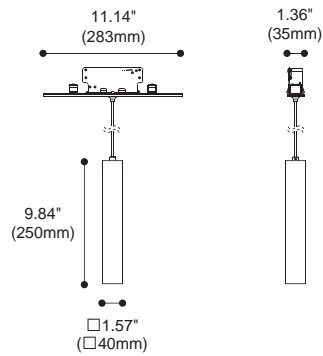

- Colours
- Black
 - White
- Baffle :
- Black
 - White
 - Copper

Product performance

BROWNIE 40-C3

Article number	LED Consumption	Voltage	Delivered Lumen	Beam Angle	CCT/CRI
2117.414-V	7W	120-277VAC	587 (lm)	20°/30°/40° (Lens)	30/90+

BROWNIE 40-C4

Article number	LED Consumption	Voltage	Delivered Lumen	Beam Angle	CCT/CRI
2117.415-V	13W	120-277VAC	983 (lm)	20°/30°/40° (Lens)	30/90+

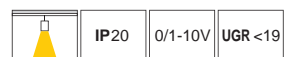



BROWNIE 40-C

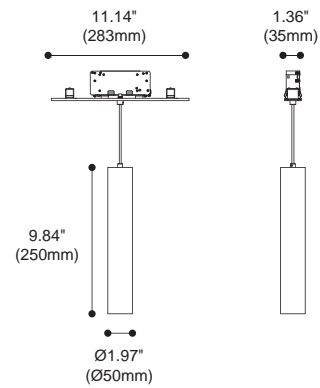

- Colours
- Black
 - White
- Baffle :
- Black
 - White
 - Copper

Product performance

BROWNIE 40-C6

Article number	LED Consumption	Voltage	Delivered Lumen	Beam Angle	CCT/CRI
2117.459-V	20W	120-277VAC	1666 (lm)	20°/30°/40° (Lens)	30/90+

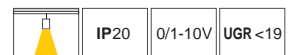



BROWNIE 40-LC

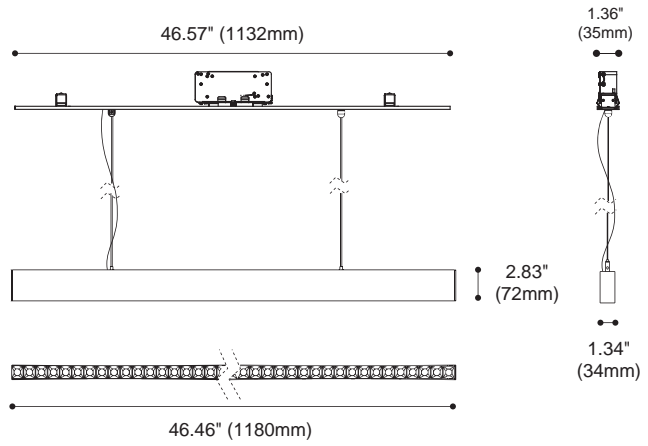
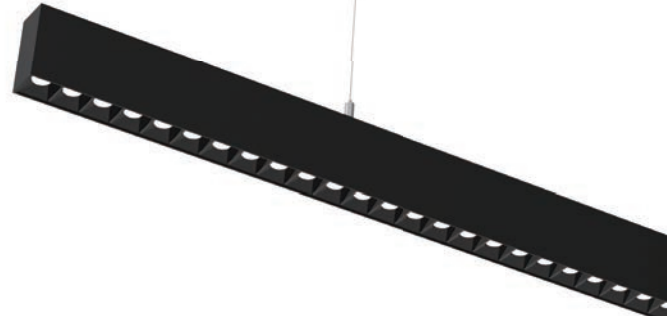

Colours Black White

Product performance

BROWNIE 40-LC					
Article number	LED Consumption	Voltage	Delivered Lumen	Beam Angle	CCT/CRI
2117.457-V	25W	120-277VAC	2112 (lm)	45° (Lens)	30/90+





Luminous intensity distribution diagram

2117.402-V

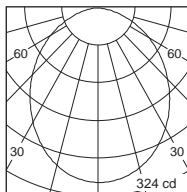

h (m)	D (m)	E (lx)
100°		
1.0	2.23	324
2.0	4.45	81
3.0	6.68	36
4.0	8.91	20
5.0	11.13	12

2117.416-V

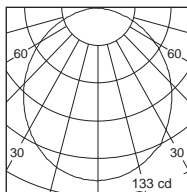

h (m)	D (m)	E (lx)
100°		
1.0	2.54	133
2.0	5.07	33
3.0	7.61	14
4.0	10.15	8
5.0	12.68	5

2117.417-V

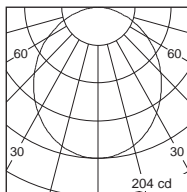

h (m)	D (m)	E (lx)
100°		
1.0	2.47	204
2.0	4.94	51
3.0	7.41	22
4.0	9.88	12
5.0	12.34	8

2117.418-V

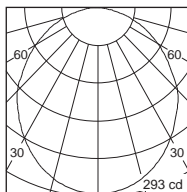

h (m)	D (m)	E (lx)
100°		
1.0	2.48	293
2.0	4.97	73
3.0	7.45	32
4.0	9.93	18
5.0	12.41	11

2117.404-6-V

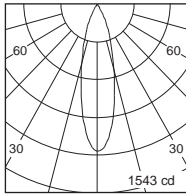

h (m)	D (m)	E (lx)
26°		
1.0	0.47	1545
2.0	0.94	386
3.0	1.41	171
4.0	1.88	96
5.0	2.35	61

2117.404-6-V

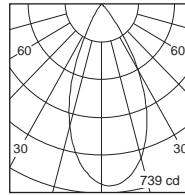

h (m)	D (m)	E (lx)
47°		
1.0	0.87	738
2.0	1.74	184
3.0	2.61	82
4.0	3.48	41
5.0	4.35	29

2117.411-V

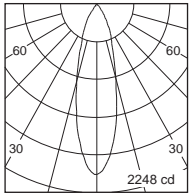

h (m)	D (m)	E (lx)
27°		
1.0	0.46	2244
2.0	0.92	561
3.0	1.37	249
4.0	1.84	140
5.0	2.30	89

2117.411-V

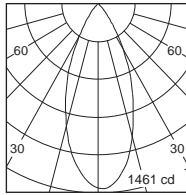

h (m)	D (m)	E (lx)
41°		
1.0	0.72	1460
2.0	1.45	364
3.0	2.17	162
4.0	2.90	91
5.0	3.62	58

2117.411-V

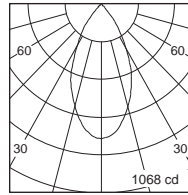

h (m)	D (m)	E (lx)
51°		
1.0	0.95	1065
2.0	1.90	266
3.0	2.84	118
4.0	3.79	66
5.0	4.74	42

2117.405-V

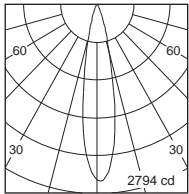

h (m)	D (m)	E (lx)
20°		
1.0	0.35	2804
2.0	0.71	701
3.0	1.06	311
4.0	1.41	175
5.0	1.76	112

2117.405-V

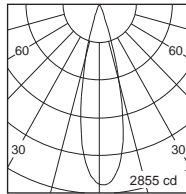

h (m)	D (m)	E (lx)
25°		
1.0	0.44	2860
2.0	0.89	715
3.0	1.33	317
4.0	1.77	178
5.0	2.22	114

2117.408-V

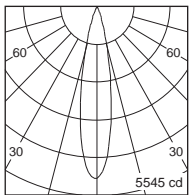

h (m)	D (m)	E (lx)
20°		
1.0	0.34	5659
2.0	0.69	1415
3.0	1.03	628
4.0	1.37	353
5.0	1.72	226

2117.408-V

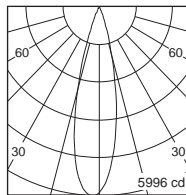

h (m)	D (m)	E (lx)
24°		
1.0	0.43	5956
2.0	0.86	1489
3.0	1.30	661
4.0	1.73	372
5.0	2.16	238

2117.406-V

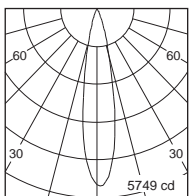

h (m)	D (m)	E (lx)
22°		
1.0	0.39	5764
2.0	0.78	1441
3.0	1.16	640
4.0	1.55	360
5.0	1.94	230

2117.406-V

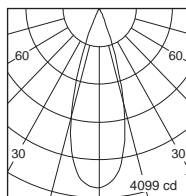

h (m)	D (m)	E (lx)
32°		
1.0	0.56	4081
2.0	1.12	1020
3.0	1.69	453
4.0	2.25	255
5.0	2.82	163

2117.406-V

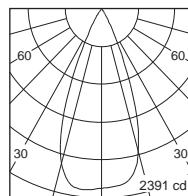

h (m)	D (m)	E (lx)
42°		
1.0	0.76	2364
2.0	1.52	591
3.0	2.28	262
4.0	3.05	147
5.0	3.81	94

2117.409-V

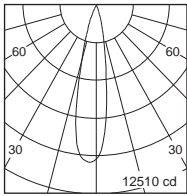

h (m)	D (m)	E (lx)
21°		
1.0	0.36	12534
2.0	0.72	3133
3.0	1.09	1393
4.0	1.46	783
5.0	1.82	501

2117.409-V

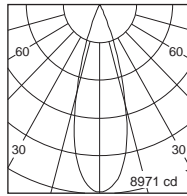

h (m)	D (m)	E (lx)
30°		
1.0	0.54	8972
2.0	1.07	2243
3.0	1.61	996
4.0	2.14	560
5.0	2.68	358

2117.409-V

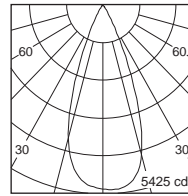

h (m)	D (m)	E (lx)
40°		
1.0	0.72	5414
2.0	1.44	1353
3.0	2.16	601
4.0	2.88	338
5.0	3.60	216

2117.450-V

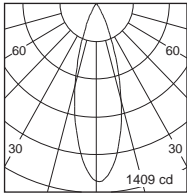

h (m)	D (m)	E (lx)
30°		
1.0	0.53	1416
2.0	1.07	354
3.0	1.60	157
4.0	2.14	88
5.0	2.67	56

2117.412-V

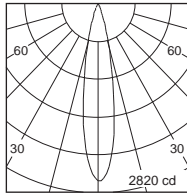

h (m)	D (m)	E (lx)
20°		
1.0	0.35	2808
2.0	0.70	702
3.0	1.05	312
4.0	1.39	175
5.0	1.74	112

2117.412-V

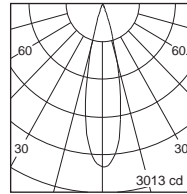

h (m)	D (m)	E (lx)
25°		
1.0	0.41	3006
2.0	0.82	751
3.0	1.23	334
4.0	1.64	187
5.0	2.06	120

2117.412-V

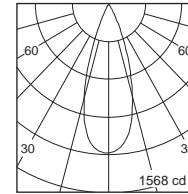

h (m)	D (m)	E (lx)
36°		
1.0	0.62	1567
2.0	1.24	391
3.0	1.86	174
4.0	2.48	97
5.0	3.10	62

2117.413-V

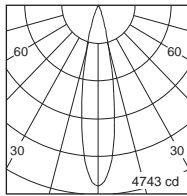

h (m)	D (m)	E (lx)
21°		
1.0	0.36	4752
2.0	0.72	1188
3.0	1.09	528
4.0	1.45	297
5.0	1.81	190

2117.413-V

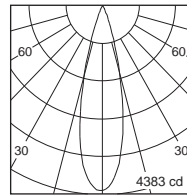

h (m)	D (m)	E (lx)
26°		
1.0	0.45	4392
2.0	0.90	1098
3.0	1.36	488
4.0	1.81	274
5.0	2.26	175

2117.414-V

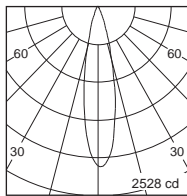

h (m)	D (m)	E (lx)
22°		
1.0	0.39	2545
2.0	0.78	636
3.0	1.18	282
4.0	1.57	159
5.0	1.96	101

2117.415-V

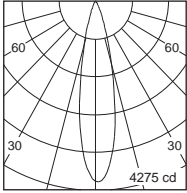

h (m)	D (m)	E (lx)
22°		
1.0	0.39	4293
2.0	0.78	1073
3.0	1.17	477
4.0	1.56	268
5.0	1.95	171

2117.459-V

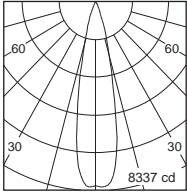

h (m)	D (m)	E (lx)
22°		
1.0	0.39	8320
2.0	0.78	2080
3.0	1.17	924
4.0	1.57	520
5.0	1.96	332

2117.459-V

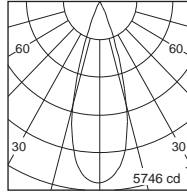

h (m)	D (m)	E (lx)
32°		
1.0	0.57	5731
2.0	1.15	1433
3.0	1.72	636
4.0	2.29	358
5.0	2.87	229

2117.459-V

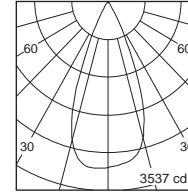

h (m)	D (m)	E (lx)
42°		
1.0	0.77	3504
2.0	1.53	875
3.0	2.30	389
4.0	3.06	219
5.0	3.83	140