



BROWNIE 60 (EU) system



BROWNIE 60(EU)

Creativity in linear style

Innovative slim linear connecting system, a perfect combination between tracks and LED fixtures. Not only emphasizing on characteristics and rapid installation of the modules, also creates simple and clean appearance. Unique designed spot, panel and downlight modules are available for multitasking lighting requirement to the area. This is a perfect solution to maximize lighting creativity.

BROWNIE 60 (EU)

BROWNIE 60 TRACK

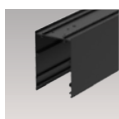

BNT-11



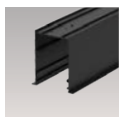











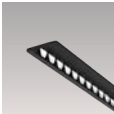

Surface / Pendant Track



BNF-11

Recessed Track

BROWNIE 60 MODULES

	Series name	LED Consumption	Lumen
	BROWNIE 60-P	16W	948 (lm)
		30.6W	948 (lm) X2
	BROWNIE 60-P	6.5W	396 (lm)
		6.5W	388 (lm)
		9.4W	599 (lm)
		12.6W	754 (lm)
	BROWNIE 60-W	23W	1870 (lm)
			
	BROWNIE 60-K	11W	820 (lm)
		22W	1599 (lm)
	BROWNIE 60-G	6W X2	948 (lm)
			
	BROWNIE 60-S	7W	567 (lm)
		13W	1172 (lm)
		26W	2829 (lm)
		38W	3050 (lm)
		7W X2	1147 (lm)
		13W X2	2376 (lm)
26W X2	2829 (lm) X2		
	BROWNIE 60-C	7W	437 (lm)
		13W	951 (lm)
		20W	1666 (lm)
	BROWNIE 60-LC	25W	2113 (lm)
			



BROWNIE 60 (EU)

linear connecting system, can be recessed, surface mounted or pendant. Suitable for all kinds of interior environment. The LED modules are designed with simple linear style, each series perform its own function, making lighting design easier than ever.

BROWNIE 60 (EU)

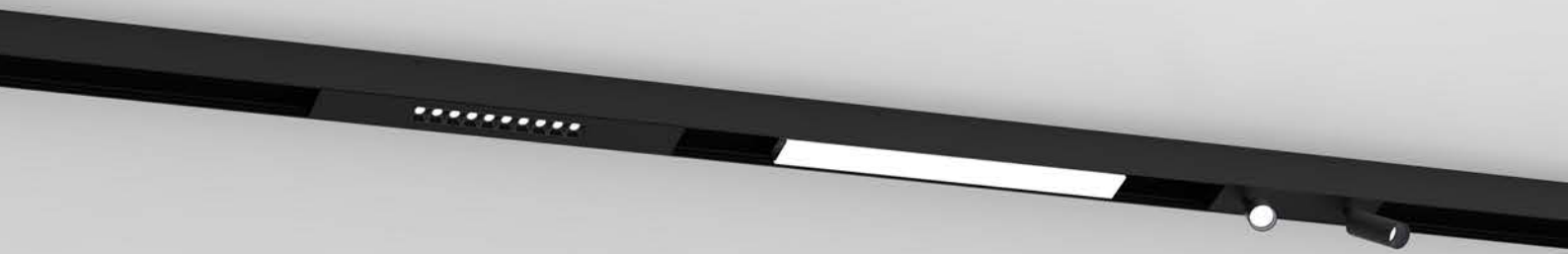

Recessed

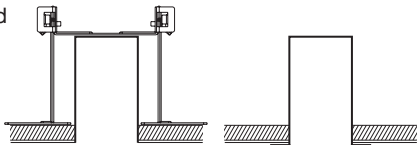

Surface mounted

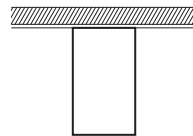

Pendant

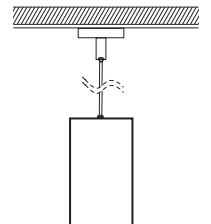



Quickinfo

GENERAL

Recessed

Pendant

Surface mounted

ELECTRICAL

0-10V

PHYSICAL

Aluminium

Spray powder

Description

With the ingenious mechanics, BROWNIE 60 brings a new picture to display lighting solutions for both pendant & surface mounted system.

The system can add different kind of the lighting module you want and offering a harmonious visual expert experience.

Panel

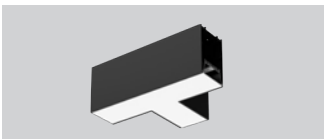

Pendant

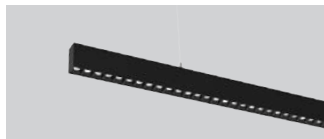

Fixed



Wallwash

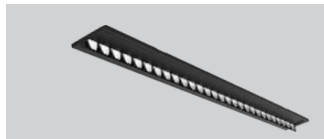

Spot



BROWNIE 60

order installation track, light insets+ mounting accessories separately

Colour Black ■ White □

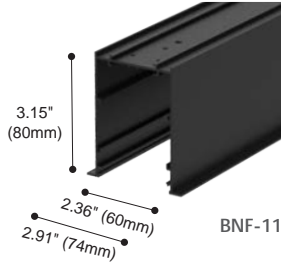
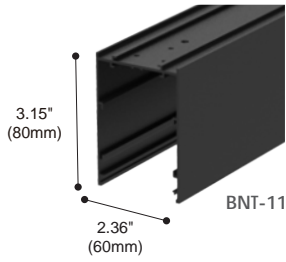

TRACK SECTION

Article number	L (mm)	TYPE
BNT-11-44	44.61"(1133mm)	Channel
BNT-11-89	89.21"(2266mm)	Channel
BNF-11-44	44.61"(1133mm)	Channel
BNF-11-89	89.21"(2266mm)	Channel

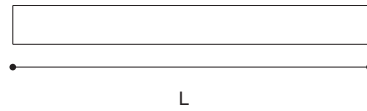

Accessories

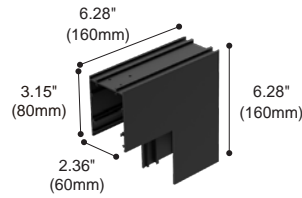
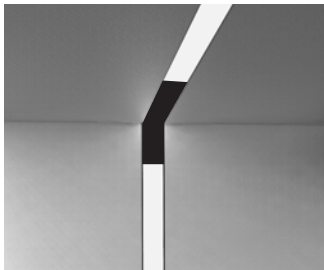

Article number: BNT-13
Type : 7 Type vertical corner

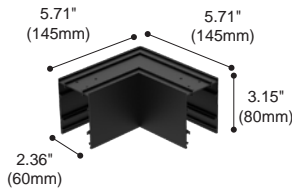
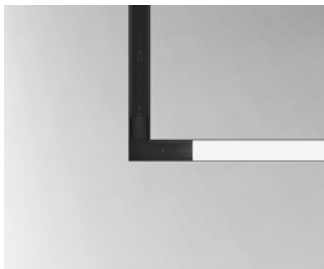

Article number: BNT-12
Type : L Type horizontal connector

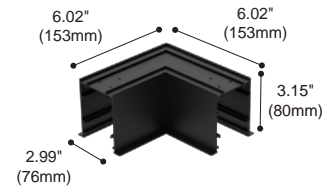

Article number: BNF-12
Type : L Type horizontal connector

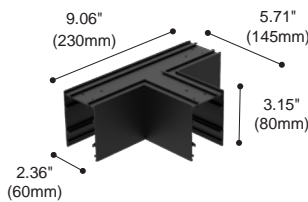

Article number: BNT-14
Type : T Type horizontal connector

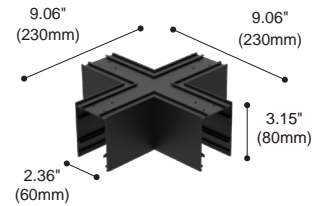

Article number: BNT-15
Type : X Type horizontal connector

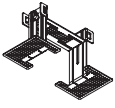

2PCS

Article number: BNR-01
Type : Trimless bracket

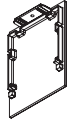

2PCS

Article number: BNC-03
Type : End cap

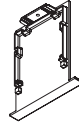

2PCS

Article number: BNC-05
Type : Trim end cap

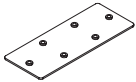

3PCS

Article number: BNC-02
Type : Surface mounted &
Pendant reinforced plate

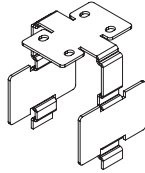

Article number: BNC-07
Type : Light Leak-proof aluminium
extrusion reinforce plate

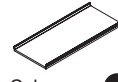

Colours
Black White

Article number:
BNE-02-11 11.14"(283mm)
BNE-02-22 22.28"(566mm)
Type : Blank cover

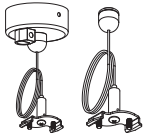

Article number: SDI-22
Type : Pendant Kit
for power connection
(without power cord)



Article number: SDI-22-V
Type : Pendant Kit
for power connection
(without power cord
and singal wire)



Article number: SDI-16
Type : Pendant kit

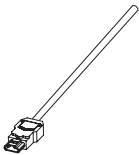

Models : CPE-41-180 71" (1800mm)
Type : Power cord connect to AC

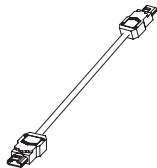

Models : CSE-41-30 12" (300mm)
CSE-41-60 24" (600mm)
Type : Power cord connect
between modules

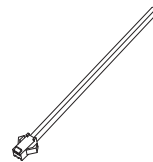

Models : CPSE-31-180 71" (1800mm)
Type : Signal wire connect
to system / dimmer

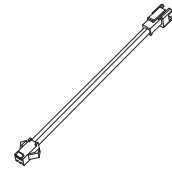

Models : CSSE-31-30 12" (300mm)
CSSE-31-60 24" (600mm)
Type : Signal wire connect
between modules





BROWNIE 60-P



P12

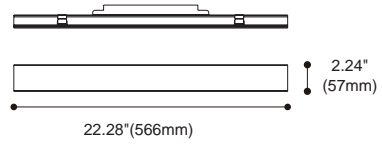

P24

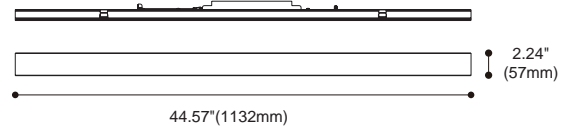

Product performance

BROWNIE 60-P12

Article number	LED Consumption	Voltage	Delivered Lumen	Beam Angle	CCT/CRI
2117.420A-V	16W	120-277VAC	948 (lm)	100°	30/90+

BROWNIE 60-P24

Article number	LED Consumption	Voltage	Delivered Lumen	Beam Angle	CCT/CRI
2117.420B-V	30.6W	120-277VAC	948 (lm) X2	100°	30/90+





BROWNIE 60-P

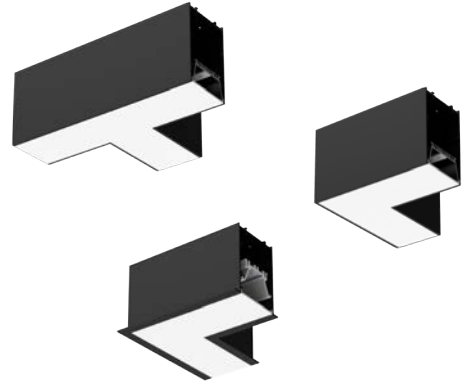

T Type

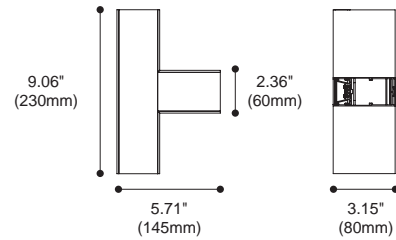

L Type

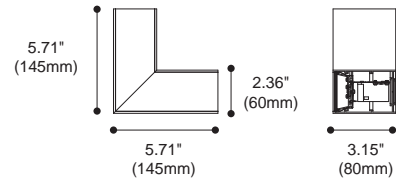

L Type trim

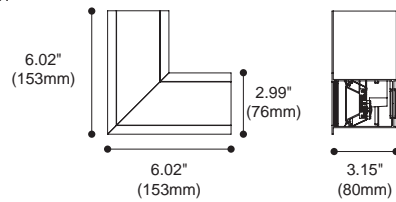

Colours Black White

Product performance

BROWNIE 60-PT Type

Article number	LED Consumption	Voltage	Delivered Lumen	Beam Angle	CCT/CRI
2117.431-V	9.4W	120-277VAC	599 (lm)	100°	30/90+

BROWNIE 60-PL Type

Article number	LED Consumption	Voltage	Delivered Lumen	Beam Angle	CCT/CRI
2117.430-V	6.5W	120-277VAC	396 (lm)	100°	30/90+

BROWNIE 60-PL Type trim

Article number	LED Consumption	Voltage	Delivered Lumen	Beam Angle	CCT/CRI
2117.469-V	6.5W	120-277VAC	396 (lm)	100°	30/90+





BROWNIE 60-P

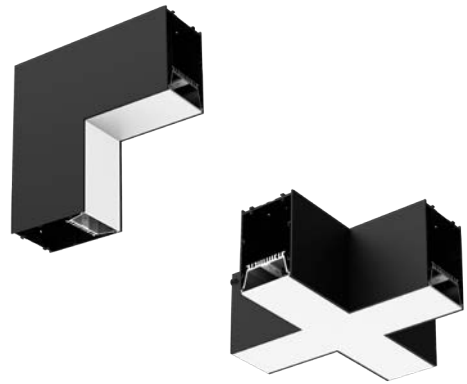

7 Type

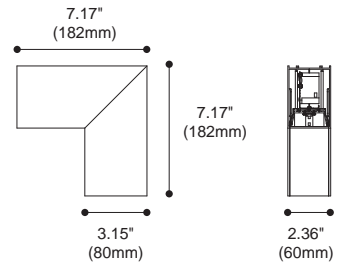

X Type

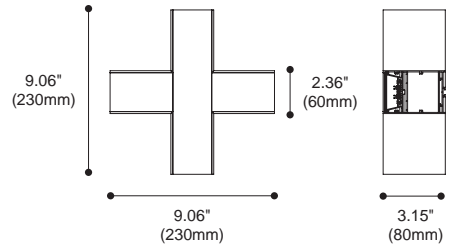

Colours Black White

Product performance

BROWNIE 60-P7 Type

Article number	LED Consumption	Voltage	Delivered Lumen	Beam Angle	CCT/CRI
2117.429-V	6.5W	120-277VAC	388 (lm)	100°	30/90+

BROWNIE 60-PX Type

Article number	LED Consumption	Voltage	Delivered Lumen	Beam Angle	CCT/CRI
2117.428-V	12.6W	120-277VAC	754 (lm)	100°	30/90+





BROWNIE 60-W

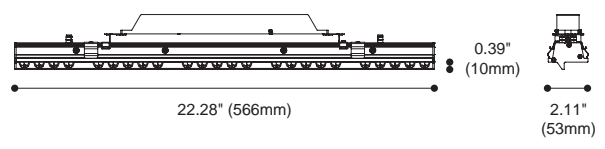
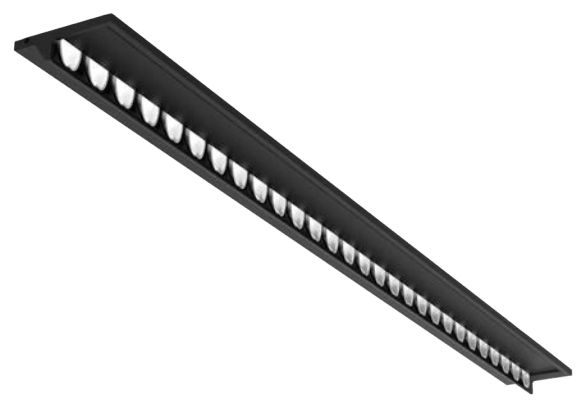

Colours Black White

Product performance

BROWNIE 60-W					
Article number	LED Consumption	Voltage	Delivered Lumen	Beam Angle	CCT/CRI
2117.421-28-V	23W	120-277VAC	1870 (lm)	55° (Reflector)	30/90+







BROWNIE 60-K

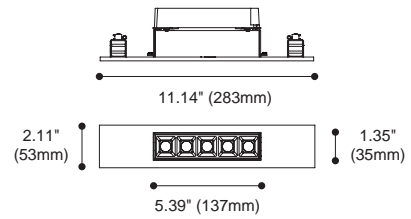

K5

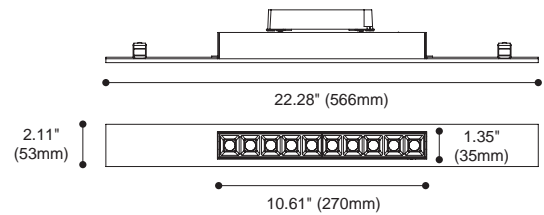

K10



- Colours Black White
- Baffle : Black White Piano black

Product performance

BROWNIE 60-K5

Article number	LED Consumption	Voltage	Delivered Lumen	Beam Angle	CCT/CRI
2117.427-5-V	11W	120-277VAC	820 (lm)	20°/30°/40° (Reflector)	30/90+

BROWNIE 60-K10

Article number	LED Consumption	Voltage	Delivered Lumen	Beam Angle	CCT/CRI
2117.427-10-V	22W	120-277VAC	1599 (lm)	20°/30°/40° (Reflector)	30/90+

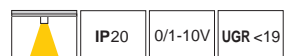



BROWNIE 60-G

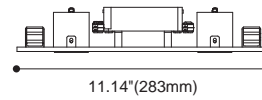

11.14"(283mm)

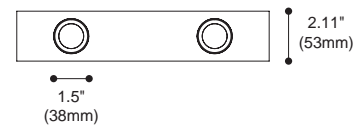

2.11"
(53mm)

1.5"
(38mm)

- Colours Black White
- Baffle : Black White

Product performance

BROWNIE 60-G

Article number	LED Consumption	Voltage	Delivered Lumen	Beam Angle	CCT/CRI
2117.426-V	6WX2	120-277VAC	948 (lm)	18°/25°/35° (Lens)	30/90+

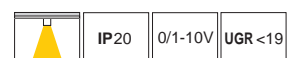



BROWNIE 60-S

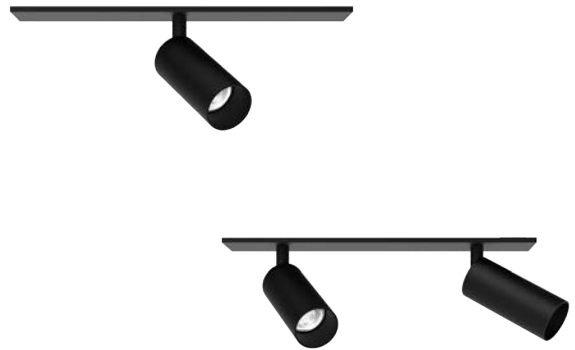

S1

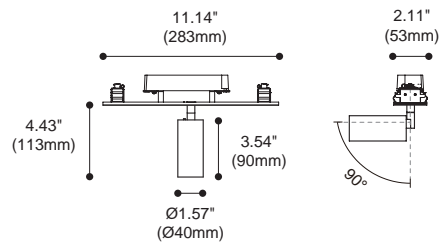

S1-2

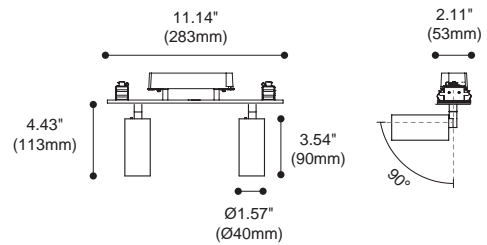

Accessories



- ACSN-11
Long baffle
- ACSG-9
Striped glass
- ACWG-10
Woven glass
- ACDS-8
Diffusion sheet
- ACHO-13
Honeycomb louver

- Colours
- Black White
- Baffle :
- Black White Copper

Product performance

BROWNIE 60-S1

Article number	LED Consumption	Voltage	Delivered Lumen	Beam Angle	CCT/CRI
2117.436-V	7W	120-277VAC	567 (lm)	20°/25°/36° (Lens)	30/90+

BROWNIE 60-S1-2

Article number	LED Consumption	Voltage	Delivered Lumen	Beam Angle	CCT/CRI
2117.433-V	7WX2	120-277VAC	1147 (lm)	20°/25°/36° (Lens)	30/90+



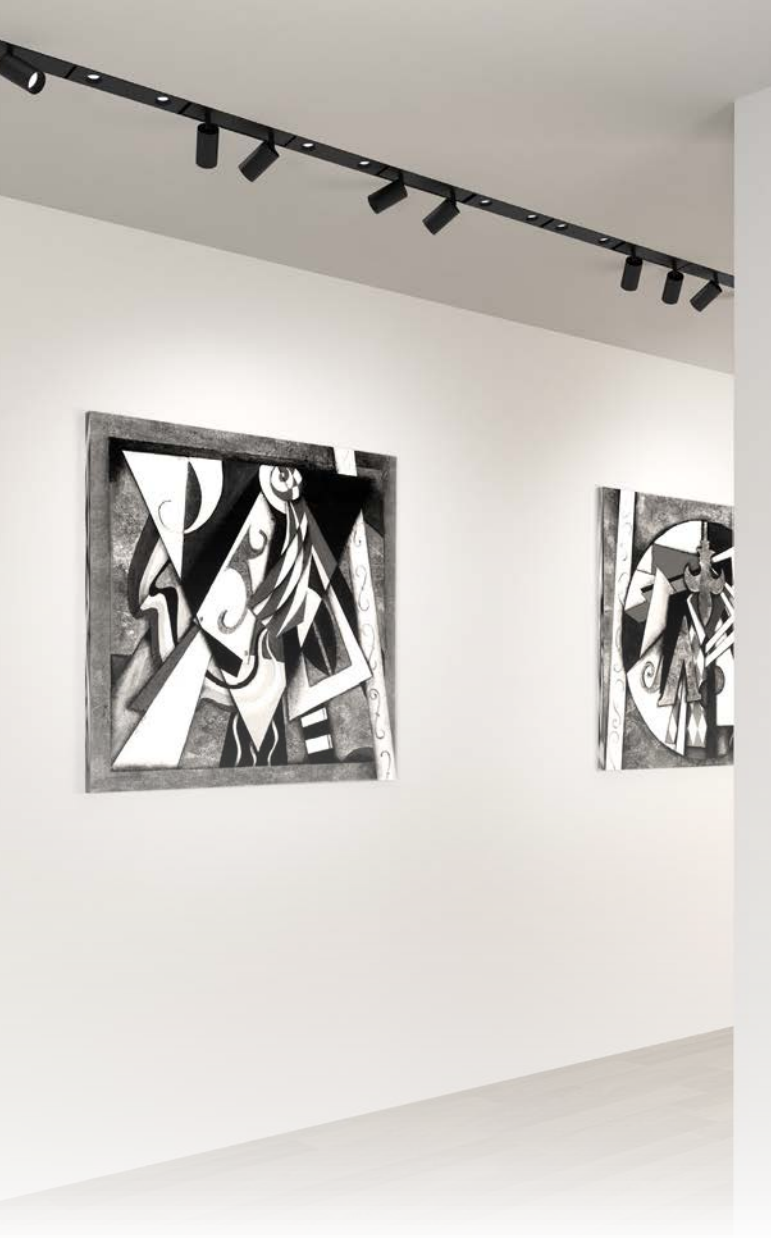

BROWNIE 60-S



S2

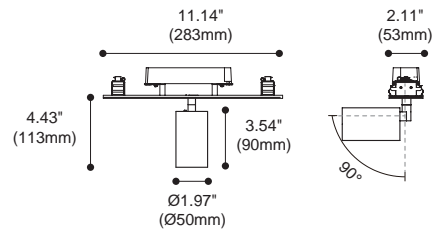

S2-2

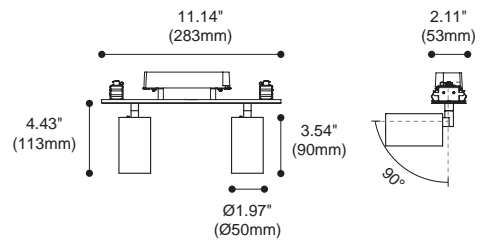

Accessories



- ACSN-12 Long baffle
- ACSG-10 Striped glass
- ACWG-11 Woven glass
- ACDS-9 Diffusion sheet
- ACHO-14 Honeycomb louver

- Colours
 Black White
- Baffle :
 Black White Copper

Product performance

BROWNIE 60-S2

Article number	LED Consumption	Voltage	Delivered Lumen	Beam Angle	CCT/CRI
2117.437-V	13W	120-277VAC	1172 (lm)	20°/30°/40° (Lens)	30/90+

BROWNIE 60-S2-2

Article number	LED Consumption	Voltage	Delivered Lumen	Beam Angle	CCT/CRI
2117.434-V	13W X2	120-277VAC	2376 (lm)	20°/30°/40° (Lens)	30/90+





BROWNIE 60-S

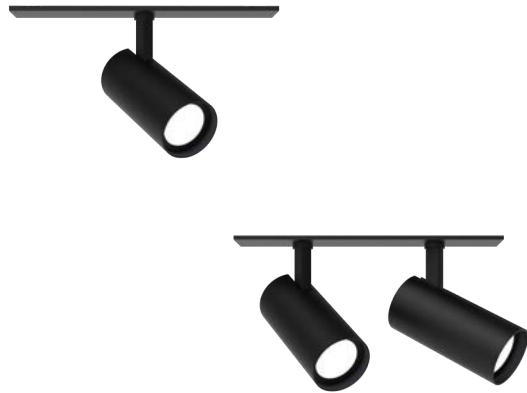

S3

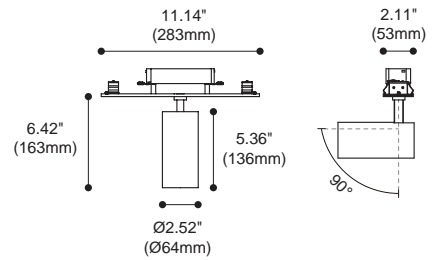

S3-2

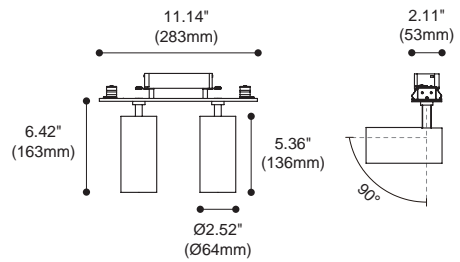

Accessories



S17-1 Long snoot
 ACSG-8 striped glass
 ACHO-11 Honeycomb louver
 ACWG-9 Woven glass

- Colours
 Black White
- Baffle :
 Black White Copper

Product performance

BROWNIE 60-S3

Article number	LED Consumption	Voltage	Lumen	Beam Angle	CCT/CRI
2117.496-V	26W	120-277VAC	2829 (lm)	17°/25°/35° (Lens)	30/90+

BROWNIE 60-S3-2

Article number	LED Consumption	Voltage	Lumen	Beam Angle	CCT/CRI
2117.497-V	26W X2	120-277VAC	2829 (lm) X2	17°/25°/35° (Lens)	30/90+





BROWNIE 60-S



S4

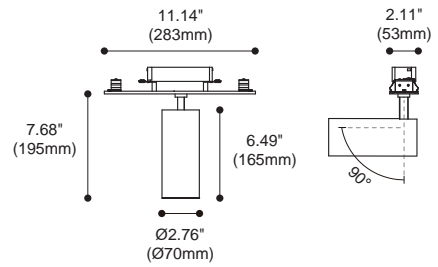

Accessories



- ACSN-10 Long snoot
- ACSG-7 Striped glass
- ACHO-10 Honeycomb louver
- ACWG-8 Woven glass

- Colours
 Black White
- Baffle :
 Black White Copper

Product performance

BROWNIE 60-S4

Article number	LED Consumption	Voltage	Delivered Lumen	Beam Angle	CCT/CRI
2117.456-V	38W	120-277VAC	3050 (lm)	17°/21°/35° (Lens)	30/90+





BROWNIE 60-C

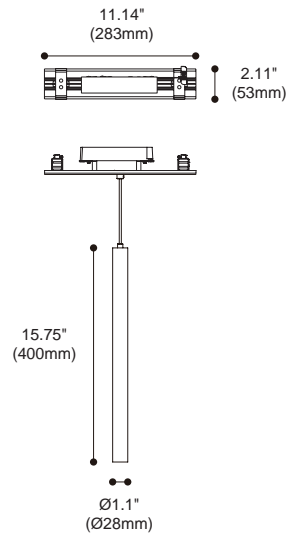
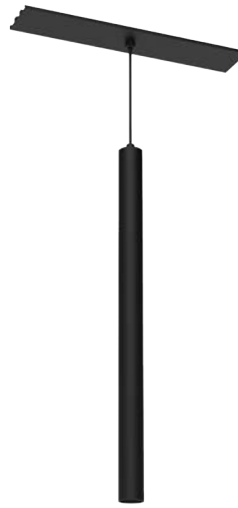

- Colours ● ○
 Black White
- Baffle : ● ○ ●
 Black White Copper

Product performance

BROWNIE 60-C5

Article number	LED Consumption	Voltage	Delivered Lumen	Beam Angle	CCT/CRI
2117.447-V	7W	120-277VAC	437 (lm)	30° (Lens)	30/90+

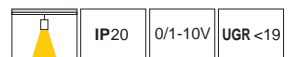



BROWNIE 60-C

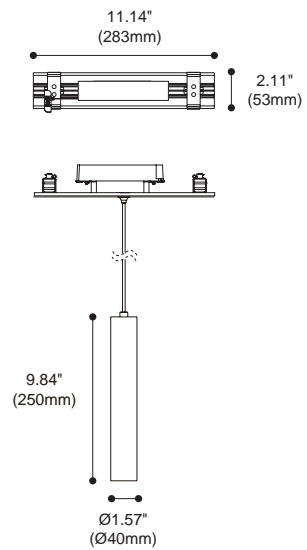

Accessories



ACHO-13
Honeycomb
louver

- Colours
- Black
 - White
- Baffle :
- Black
 - White
 - Copper

Product performance

BROWNIE 60-C1

Article number	LED Consumption	Voltage	Delivered Lumen	Beam Angle	CCT/CRI
2117.424-V	7W	120-277VAC	557 (lm)	20°/25°/36° (Lens)	30/90+

BROWNIE 60-C2

Article number	LED Consumption	Voltage	Delivered Lumen	Beam Angle	CCT/CRI
2117.425-V	13W	120-277VAC	951 (lm)	20°/25°/36° (Lens)	30/90+

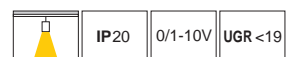



BROWNIE 60-C

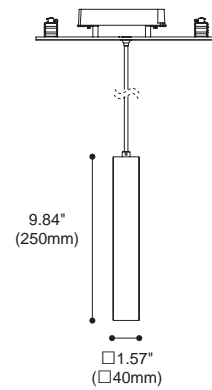
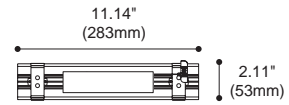
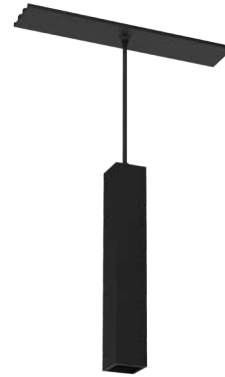

- Colours
 Black White
- Baffle :
 Black White Copper

Product performance

BROWNIE 60-C3

Article number	LED Consumption	Voltage	Delivered Lumen	Beam Angle	CCT/CRI
2117.422-V	7W	120-277VAC	587 (lm)	20°/25°/40° (Lens)	30/90+

BROWNIE 60-C4

Article number	LED Consumption	Voltage	Delivered Lumen	Beam Angle	CCT/CRI
2117.423-V	13W	120-277VAC	983 (lm)	20°/25°/40° (Lens)	30/90+

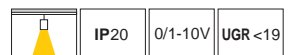



BROWNIE 60-C

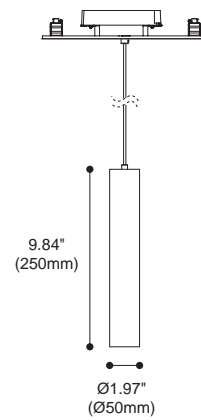
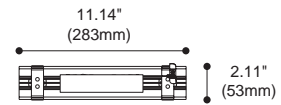

- Colours
 Black White
- Baffle :
 Black White Copper

Product performance

BROWNIE 60-C6

Article number	LED Consumption	Voltage	Delivered Lumen	Beam Angle	CCT/CRI
2117.460-V	20W	120-277VAC	1666 (lm)	20°/30°/40° (Lens)	30/90+

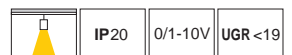



BROWNIE 60-LC

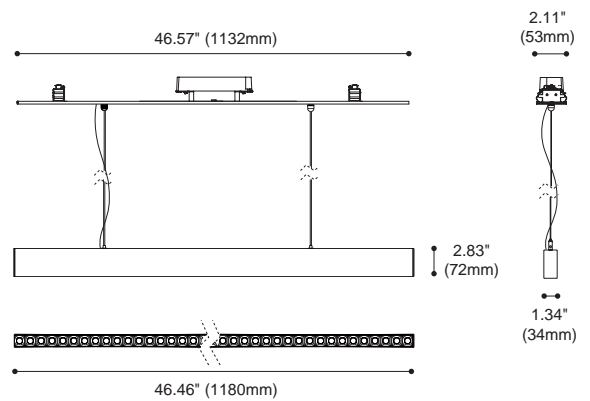
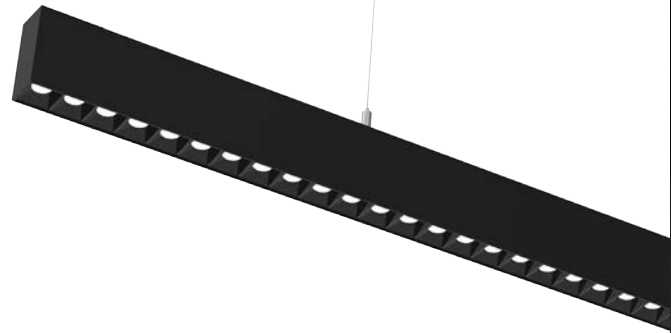

Colours Black White

Product performance

BROWNIE 60-LC

Article number	LED Consumption	Voltage	Lumen	Beam Angle	CCT/CRI
2117.458-V	25W	120-277VAC	2113 (lm)	45° (Lens)	30/90+





Luminous intensity distribution diagram

2117.420A-V

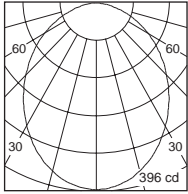

h (m)	D (m)	E (lx)
100°		
1.0	2.16	397
2.0	4.32	99
3.0	6.48	44
4.0	8.64	24
5.0	10.80	15

2117.431-V

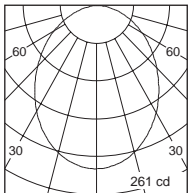

h (m)	D (m)	E (lx)
100°		
1.0	2.05	257
2.0	4.11	64
3.0	6.16	28
4.0	8.22	16
5.0	10.27	10

2117.430-V

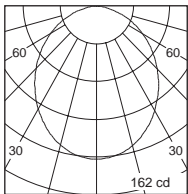

h (m)	D (m)	E (lx)
100°		
1.0	2.30	162
2.0	4.60	40
3.0	6.89	18
4.0	9.19	10
5.0	11.49	6

2117.469-V

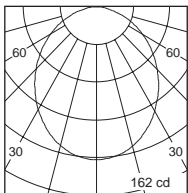

h (m)	D (m)	E (lx)
100°		
1.0	2.30	162
2.0	4.60	40
3.0	6.89	18
4.0	9.19	10
5.0	11.49	6

2117.428-V

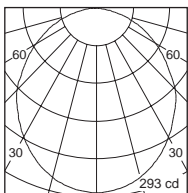

h (m)	D (m)	E (lx)
100°		
1.0	2.48	293
2.0	4.97	74
3.0	7.45	32
4.0	9.93	18
5.0	12.41	11

2117.427-5-V

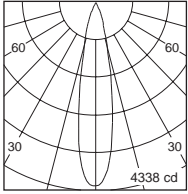

h (m)	D (m)	E (lx)
20°		
1.0	0.36	4348
2.0	0.73	1087
3.0	1.09	483
4.0	1.45	271
5.0	1.82	173

2117.427-5-V

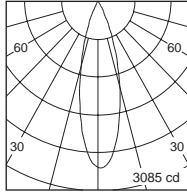

h (m)	D (m)	E (lx)
30°		
1.0	0.49	3096
2.0	0.98	774
3.0	1.47	344
4.0	1.97	193
5.0	2.45	123

2117.427-5-V

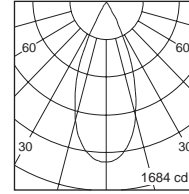

h (m)	D (m)	E (lx)
40°		
1.0	0.76	1684
2.0	1.53	421
3.0	2.29	187
4.0	3.06	105
5.0	3.82	67

2117.427-10-V

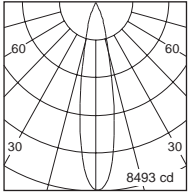

h (m)	D (m)	E (lx)
20°		
1.0	0.36	8524
2.0	0.71	2131
3.0	1.07	947
4.0	1.43	532
5.0	1.78	341

2117.427-10-V

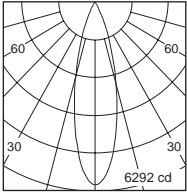

h (m)	D (m)	E (lx)
30°		
1.0	0.47	6322
2.0	0.94	1581
3.0	1.42	702
4.0	1.89	395
5.0	2.36	252

2117.427-10-V

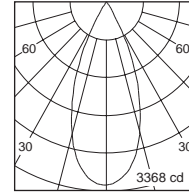

h (m)	D (m)	E (lx)
40°		
1.0	0.75	3376
2.0	1.50	843
3.0	2.25	375
4.0	3.00	211
5.0	3.75	135

2117.426-V

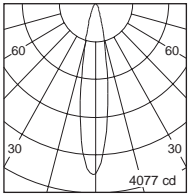

h (m)	D (m)	E (lx)
18°		
1.0	0.32	4071
2.0	0.65	1018
3.0	0.97	452
4.0	1.30	254
5.0	1.62	162

2117.426-V



h (m)	D (m)	E (lx)
25°		
1.0	0.46	3284
2.0	0.92	820
3.0	1.39	364
4.0	1.85	205
5.0	2.31	131

2117.426-V

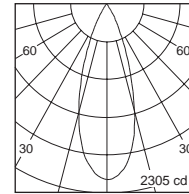

h (m)	D (m)	E (lx)
35°		
1.0	0.63	2306
2.0	1.27	576
3.0	1.90	256
4.0	2.53	144
5.0	3.17	92

2117.436-V

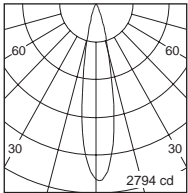

h (m)	D (m)	E (lx)
20°		
1.0	0.35	2804
2.0	0.71	701
3.0	1.06	311
4.0	1.41	175
5.0	1.76	112

2117.436-V

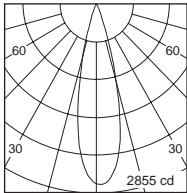

h (m)	D (m)	E (lx)
25°		
1.0	0.44	2860
2.0	0.89	715
3.0	1.33	317
4.0	1.77	178
5.0	2.22	114

2117.433-V

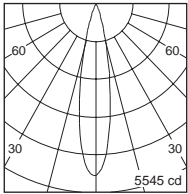

h (m)	D (m)	E (lx)
20°		
1.0	0.34	5659
2.0	0.69	1415
3.0	1.03	628
4.0	1.37	353
5.0	1.72	226

2117.433-V

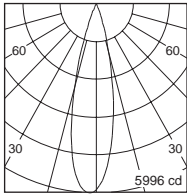

h (m)	D (m)	E (lx)
25°		
1.0	0.43	5956
2.0	0.86	1489
3.0	1.30	661
4.0	1.73	372
5.0	2.16	238

2117.437-V

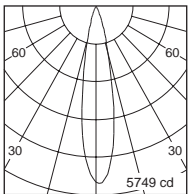

h (m)	D (m)	E (lx)
20°		
1.0	0.39	5764
2.0	0.78	1441
3.0	1.16	640
4.0	1.55	360
5.0	1.94	230

2117.437-V

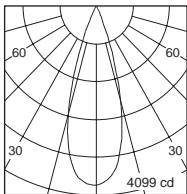

h (m)	D (m)	E (lx)
30°		
1.0	0.56	4081
2.0	1.12	1020
3.0	1.69	453
4.0	2.25	255
5.0	2.82	163

2117.437-V

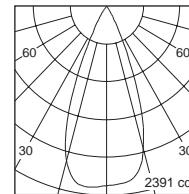

h (m)	D (m)	E (lx)
40°		
1.0	0.76	2364
2.0	1.52	591
3.0	2.28	262
4.0	3.05	147
5.0	3.81	94

2117.434-V

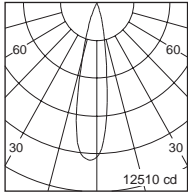

h (m)	D (m)	E (lx)
20°		
1.0	0.36	12534
2.0	0.72	3133
3.0	1.09	1393
4.0	1.46	783
5.0	1.82	501

2117.434-V

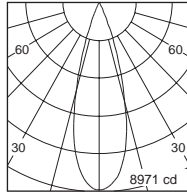

h (m)	D (m)	E (lx)
30°		
1.0	0.54	8972
2.0	1.07	2243
3.0	1.61	996
4.0	2.14	560
5.0	2.68	358

2117.434-V

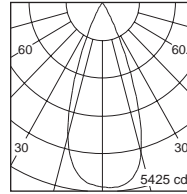

h (m)	D (m)	E (lx)
40°		
1.0	0.72	5414
2.0	1.44	1353
3.0	2.16	601
4.0	2.88	338
5.0	3.60	216

2117.456-V

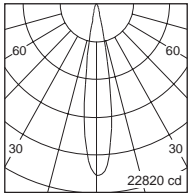

h (m)	D (m)	E (lx)
17°		
1.0	0.30	22919
2.0	0.60	5730
3.0	0.89	2547
4.0	1.19	1432
5.0	1.49	916

2117.456-V

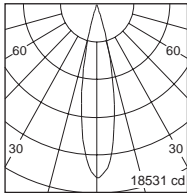

h (m)	D (m)	E (lx)
21°		
1.0	0.38	18465
2.0	0.75	4616
3.0	1.13	2052
4.0	1.51	1154
5.0	1.89	738

2117.456-V

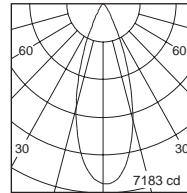

h (m)	D (m)	E (lx)
35°		
1.0	0.63	7191
2.0	1.27	1798
3.0	1.90	799
4.0	2.54	449
5.0	3.17	287

2117.447-V

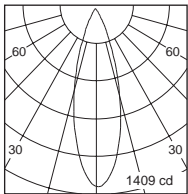

h (m)	D (m)	E (lx)
30°		
1.0	0.53	1416
2.0	1.07	354
3.0	1.60	157
4.0	2.14	88
5.0	2.67	56

2117.424-V

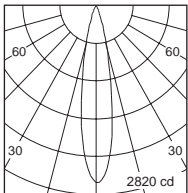

h (m)	D (m)	E (lx)
20°		
1.0	0.35	2808
2.0	0.70	702
3.0	1.05	312
4.0	1.39	175
5.0	1.74	112

2117.424-V

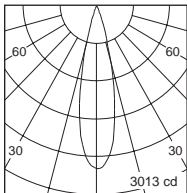

h (m)	D (m)	E (lx)
25°		
1.0	0.41	3006
2.0	0.82	751
3.0	1.23	334
4.0	1.64	187
5.0	2.06	120

2117.424-V

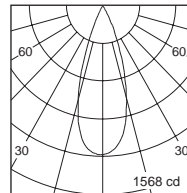

h (m)	D (m)	E (lx)
36°		
1.0	0.62	1567
2.0	1.24	391
3.0	1.86	174
4.0	2.48	97
5.0	3.10	62

2117.425-V

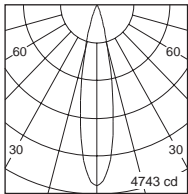

h (m)	D (m)	E (lx)
20°		
1.0	0.36	4752
2.0	0.72	1188
3.0	1.09	528
4.0	1.45	297
5.0	1.81	190

2117.425-V

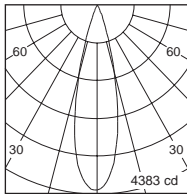

h (m)	D (m)	E (lx)
25°		
1.0	0.45	4392
2.0	0.90	1098
3.0	1.36	488
4.0	1.81	274
5.0	2.26	175

2117.422-V

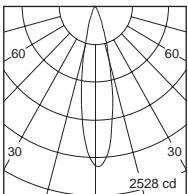

h (m)	D (m)	E (lx)
20°		
1.0	0.39	2545
2.0	0.78	636
3.0	1.18	282
4.0	1.57	159
5.0	1.96	101

