

POLE system



POLE

Using pipe connection concept
Pole creates vertical, horizontal, mesh,
Irregular, flexible, creative style
To meet all kinds of requirement.



ETL Approved

POLE

POLE TRACK

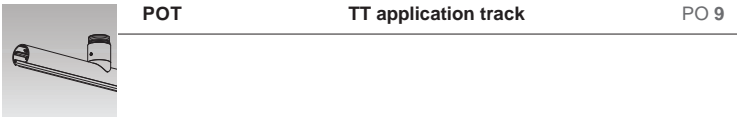

POT

TT application track

PO 9

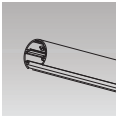

POT

ITI application track

PO 9

POLE MODULES

	Series name	LED Consumption	Lumen	Page
	POLE-L	2W 6W 12W	115 (lm) 344 (lm) 616 (lm)	PO 20
	POLE-S	6.4W	626 (lm)	PO 21
	POLE-S	2.2W	50-70 (lm)	PO 21
	POLE-K	11W	1000 (lm)	PO 22
	POLE-C	6.4W	626 (lm)	PO 23
	POLE-KC	22W	2000 (lm)	PO 24

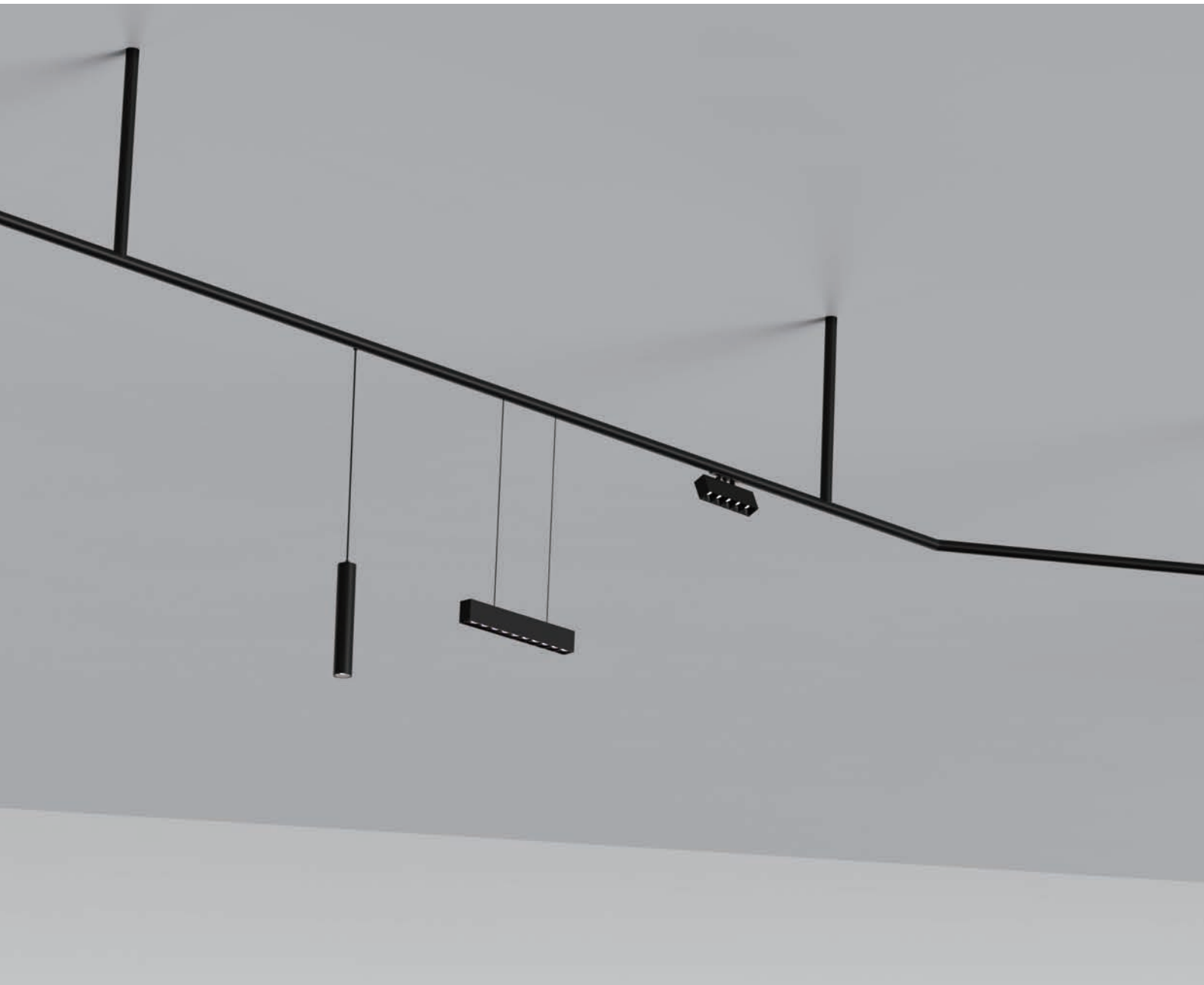

POLE modules

LED module can be installed easily with variety of style to choose from.
 Pendant module can be used on desktop, countertop
 Spot module can be used on focal lighting.
 Linear module can be used as general lighting.

Pendant lights

POLE-C
6.4W



POLE-KC
22W

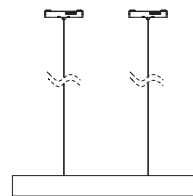



Spot lights

POLE-S

6.4W



2.2W



POLE-K

11W

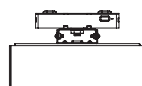

Strip lights

POLE-L 100mm 2W / 300mm 6W / 600mm 12W



POLE-L-S 100mm 2W / 300mm 6W / 600mm 12W





POLE application

Suitable for open space, combining with nordic leisure industrial style furniture,
Use different LED module to light up individual area for unique lighting effect.
LED module is designed to be click on installation.

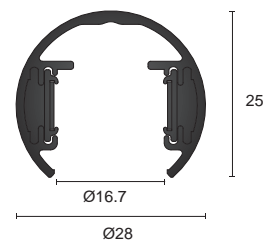



POLE track connecting system

TT connection illustration

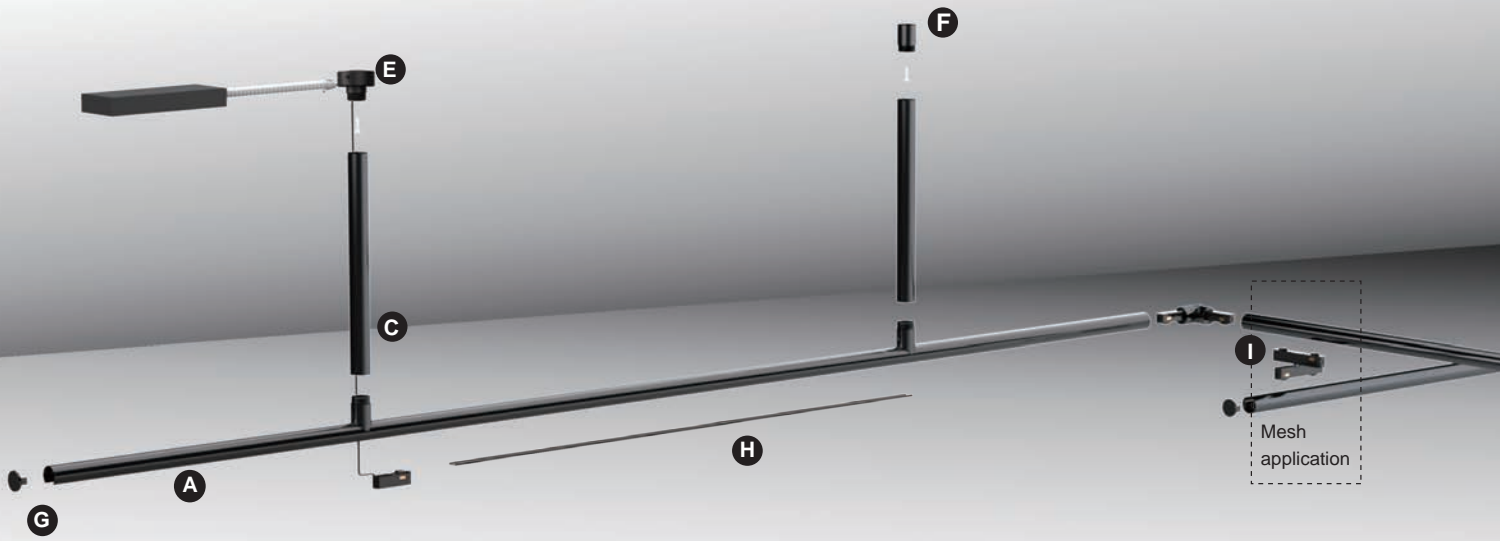

ITI connection illustration

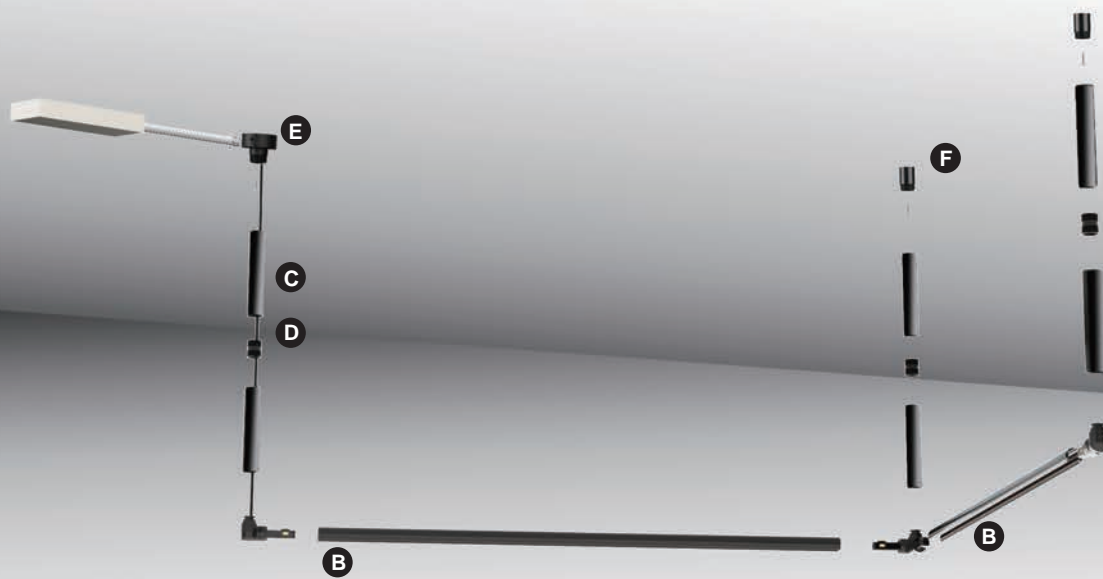

Accessories specifications

Track

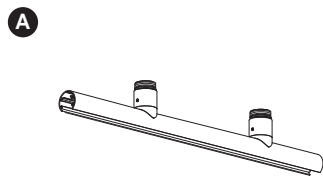

TT application track

POT-01A
Length : 1936mm
POT-01B
Length : 936mm

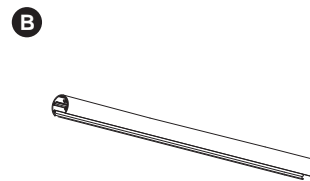

ITI application track

POT-02B
Length : 936mm
POT-02C
Length : 300mm

Fixed parts

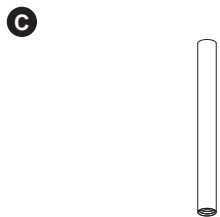

Fixed tube

POI-01A
Length : 1000mm
POI-01B
Length : 600mm
POI-01C
Length : 300mm

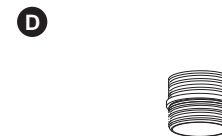

Connecting tube

POI-02

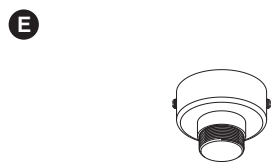

Surface mounted base for power cord

POI-03

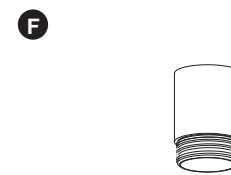

Surface mounted base

POI-04



End cap

POC-06

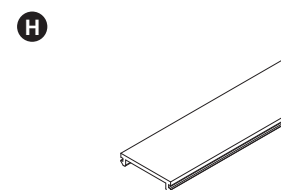

Blank cover

POE-01A
Length : 2000mm

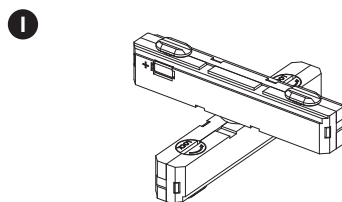

Mesh connector

POC-05

POLE loop connecting system



Electric Circuit Installation:

1. Max wattage linkable per loop for constant voltage 24VDC is 150W
2. Max length of track linkable per loop is 10M , and the max cable length between driver and power in is 2M.
3. Dimming modules are compatible to PWM output dimming driver only, PWM frequency $\leq 1.47\text{KHz}$.
4. To use drivers not on recommended list , it require compatibility test before installation.
5. Voltage drop cannot below 22VDC (measure at the end of the loop), under 22VDC per loop might cause abnormal.
6. Calculating max wattage connection, save 20% buffer for linear modules, and 25% buffer for other modules
7. Use driver not in the recommended list might cause module flickering, unstable dimming and/or noise, even causing module failure.
8. When multiple drivers are use in the connection, make sure the connector without circuit is used to divide the loop
9. When installation tracks (pipes), make sure measuring the voltage from POC-01 & POC-03 & POC-04 with the driver connected first, without modules, to see if the voltage is 24VDC, then measure the track & POC-02 & POC-04B to see if the voltage drop is $\leq 0.1\text{V}$, if the voltage drop is over 0.1V, make sure the connector is secured properly, warpage is not allowed in the connection, also check the cleanliness of the copper connector, copper connector can be cleaned using alcohol.

TT connection illustration

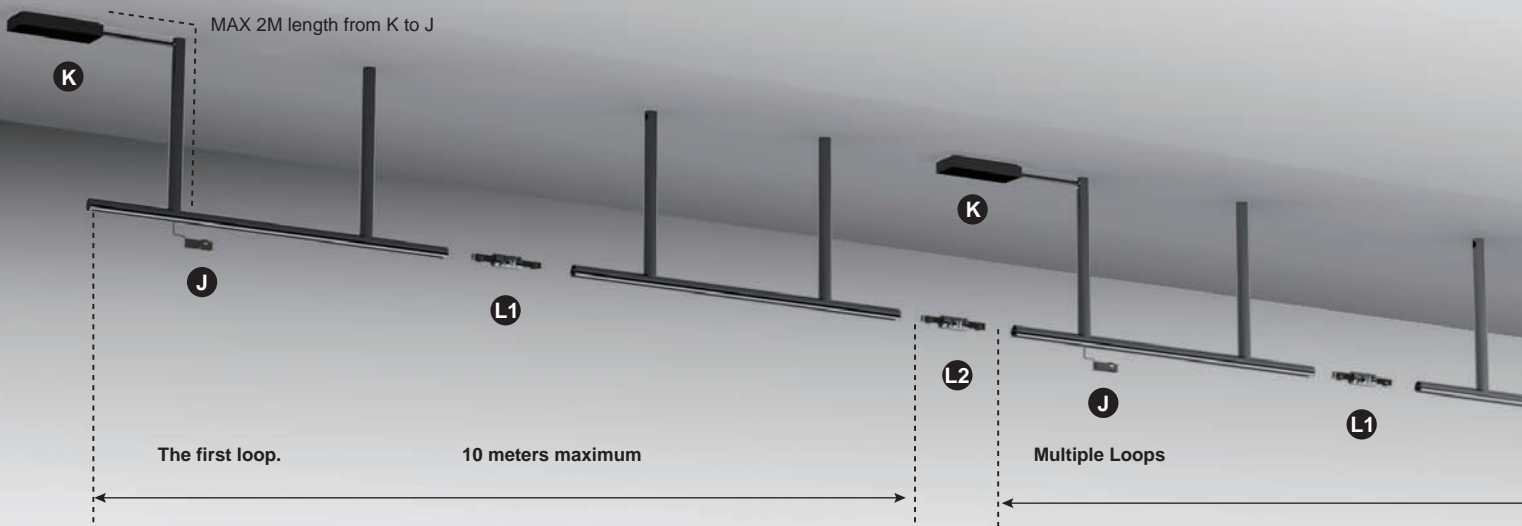

ITI connection illustration

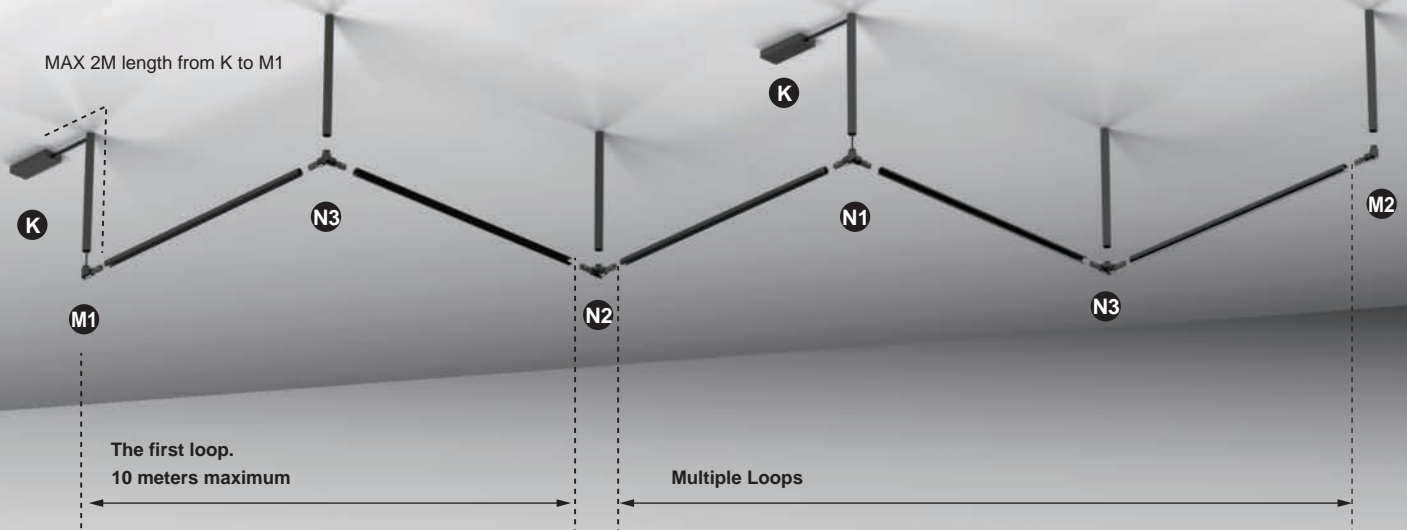

Accessories specifications

Power

J

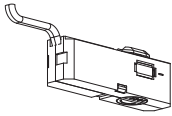

Adaptor With Power Cord

POC-01A
Length : 200cm
POC-01B
Length : 100cm

K

24V DC Driver

Connector

L1

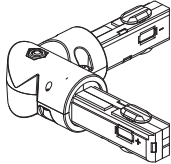

I-Connector with circuit

POC-02

L2

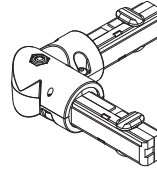

I-Connector without circuit

POC-02A

M1

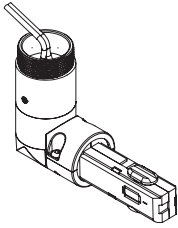

L-Connector with power cord

POC-03

M2

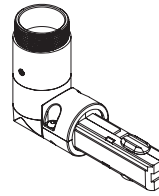

L-Connector without circuit

POC-03A

N1

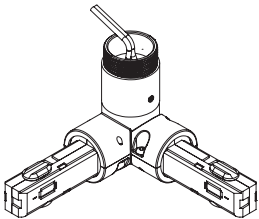

T-Connector with power cord

POC-04

N4

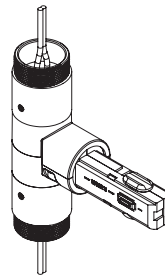

T-Connector with power cord-L

POC-04C

N2

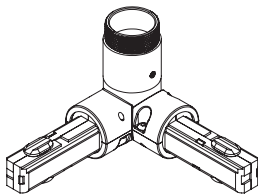

T-Connector without circuit

POC-04A

N5

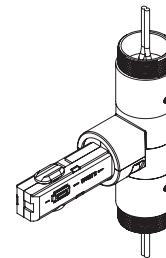

T-Connector with power cord-R

POC-04D

N3

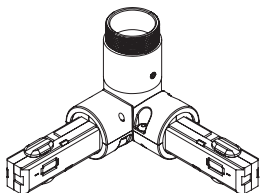

T-Connector with circuit

POC-04B



90° horizontal connection



Straight connection



90° vertical connection

TT application

TT application is designed to use POT-01 track.
Together with accessories for horizontal & vertical connections.

1936mm

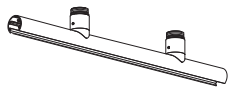

A x4



E x1



J x1

1000mm

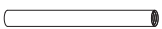

C x8



G x2



F x7

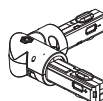

L1 x3



360°

Rotate



360°

Rotate



T connection



3-way connection

ITI application

ITI application is designed to use POT-02 track.
Together with accessories for 360 degrees rotation.

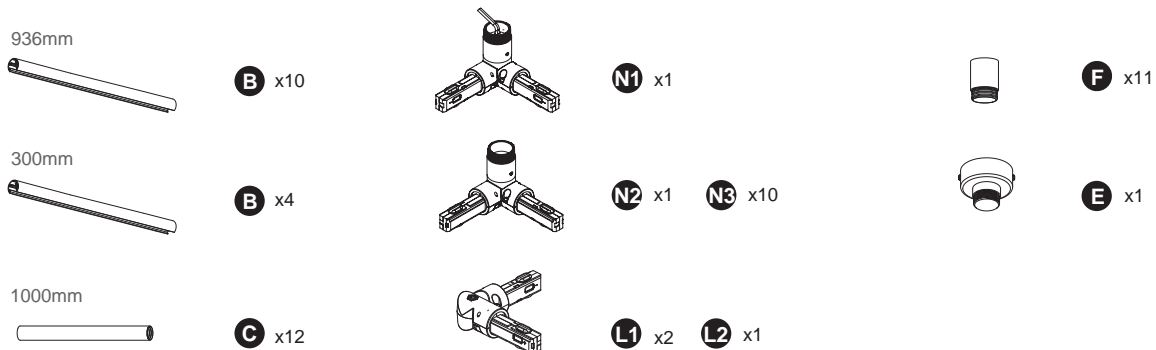

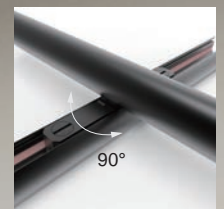

Cross connection

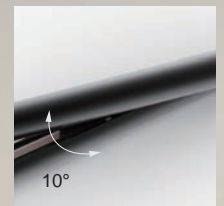

Mesh application

Mesh application uses both POT-01 & POT-02 track.
 This application creates up and down lighting effect by using POC-05 cross connector.

1936mm

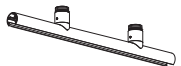

A x4

936mm

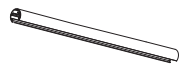

B x8

1000mm



C x12



E x1



F x11



G x8



J x1

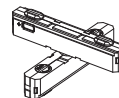

I x8

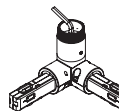

N1 x1

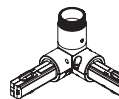

N2 x1

N3 x2

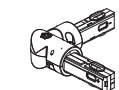

L1 x3

L2 x1

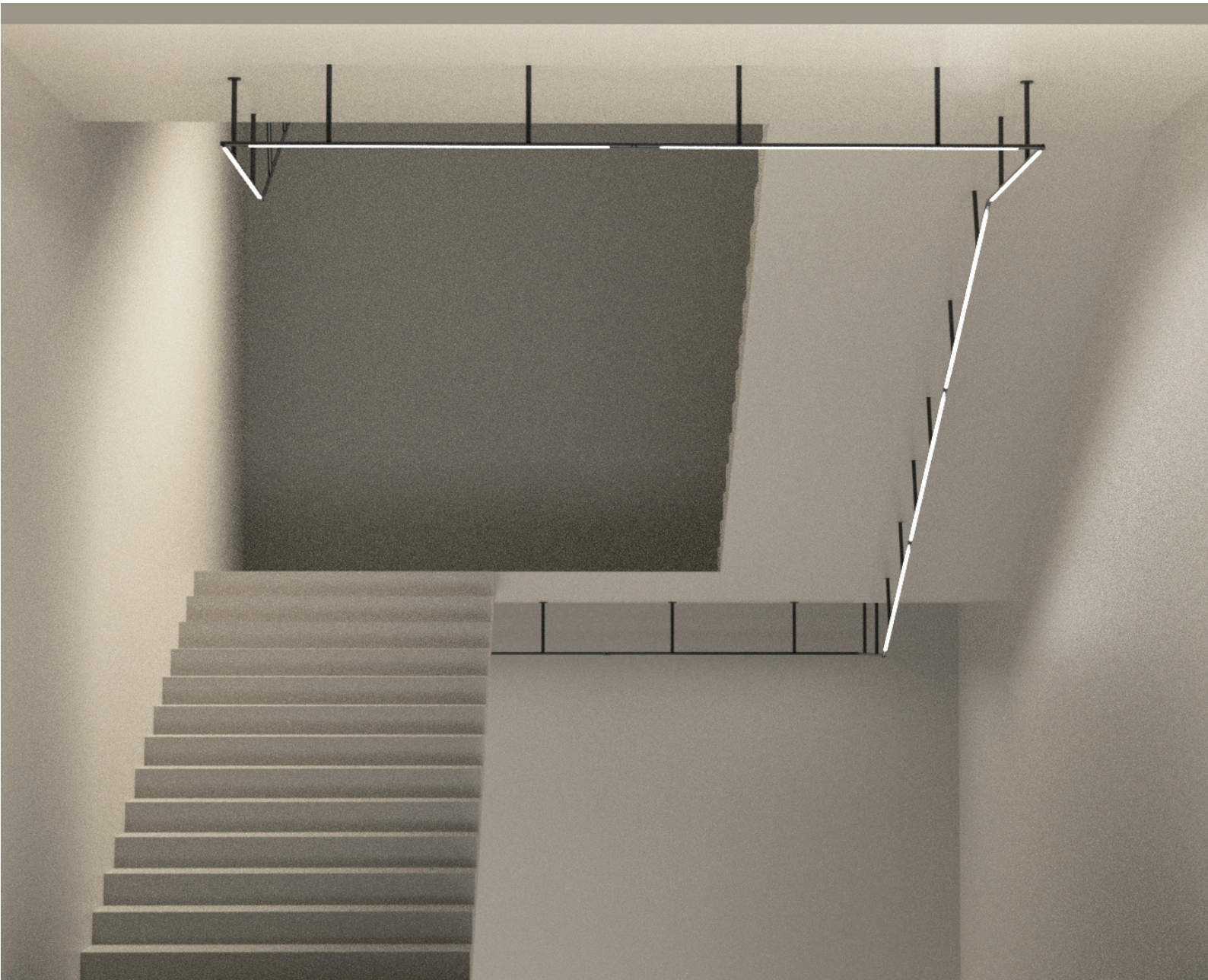

Multi-angle connection

T-Connector allows POLE to be used in different angle & height application. The connector can be bend 180 degrees max & rotate 360 degrees.

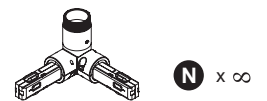
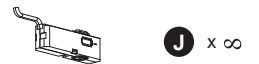
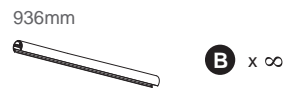



Pendant kit

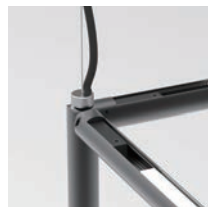

Pendant kit+Power cord

936mm



B x8

300mm



B x4

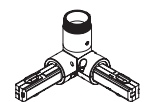

N2 x1

N3 x3

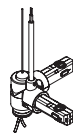

x1*

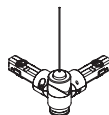

x3*

POLE-Pendant application

Can be pendant freely on the ceiling
 T-Connector is used at 90 degrees or greater.
 Suspension length can be adjusted to create stylish environment.



Rotate

(Customize)



B x5



J x5

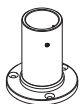

x10*

POLE-Straight application

Rotatable straight application creates all kinds of lighting possible.

*Special parts is required, please contact with our sales rep for more info.

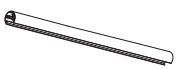

B x8

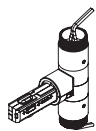

N4 x2



L1 x6

L2 x4

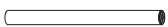

C



E x10



J x1

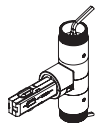

N5 x4

*Special parts is required, please contact with our sales rep for more info.

POLE-L

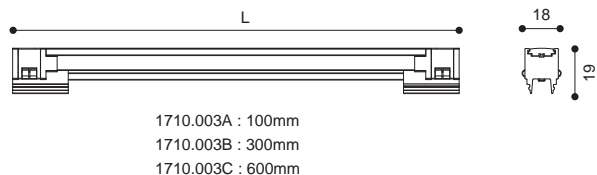

1710.003A

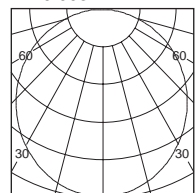

h (m)	D (m)	E (lx)
110°		
1.0	2.93	39
2.0	5.87	9
3.0	8.81	4
4.0	11.75	2
5.0	14.69	1

1710.003B

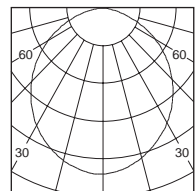

h (m)	D (m)	E (lx)
110°		
1.0	2.52	129
2.0	5.04	32
3.0	7.56	14
4.0	10.09	8
5.0	12.61	5



Colours ●
 Black

Product performance

Article number	LED Consumption	Voltage	Delivered Lumen	Beam Angle	LED Type	LED q'ty	CCT/CRI
1710.003A-V	2 W	24V DC	115 (lm)	110°	SMD	21	30/80+
1710.003B-V	6 W	24V DC	344 (lm)	110°	SMD	63	30/80+
1710.003C-V	12 W	24V DC	616 (lm)	110°	SMD	126	30/80+

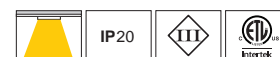

POLE-S

1719.204

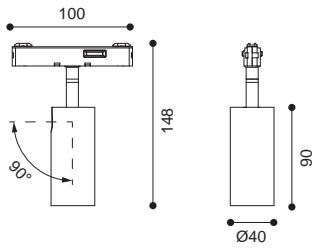

1719.204

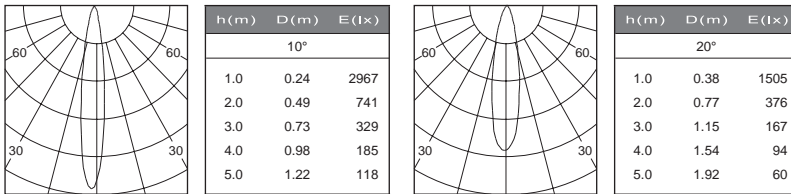

1719.203

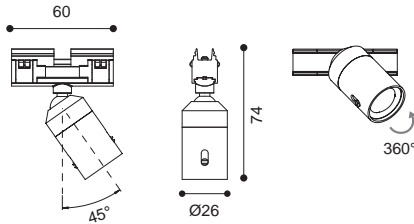

Zoom in 8°

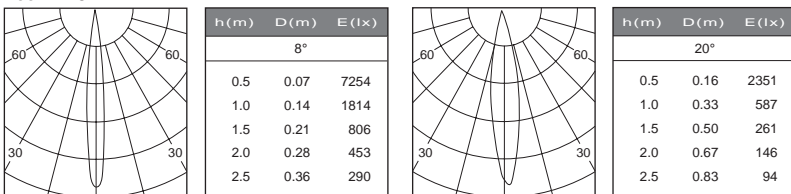

- Colours
 Black White
- Baffle :
 (1719.204) Black White Copper

Product performance

Article number	LED Consumption	Voltage	Lumen	Beam Angle	CCT/CRI
1719.204-V	6.4W	24V DC	626 (lm)	10°/20°	30/90+
Article number	LED Consumption	Voltage	Delivered Lumen	Beam Angle	CCT/CRI
1719.203-V	2.2W	24V DC	50~70 (lm)	8°-20°	30/80+



POLE-K

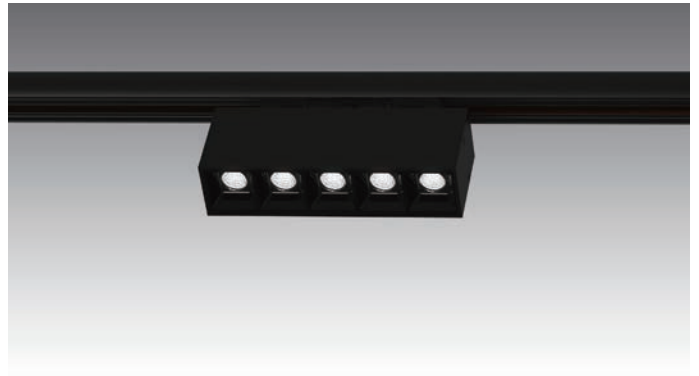
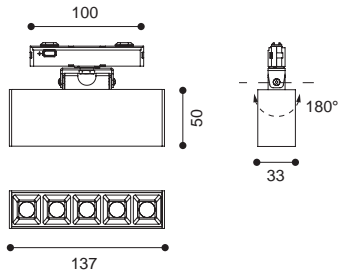

1917.400-5-V

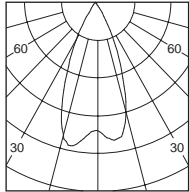

h (m)	D (m)	E (lx)
40°		
1.0	0.80	1543
2.0	1.60	385
3.0	2.40	171
4.0	3.20	96
5.0	4.00	61

- Colours Black White
- Baffle : Black White Piano black

Product performance

Article number	LED Consumption	Voltage	Lumen	Beam Angle	CCT/CRI
1917.400-5-V	11W	24V DC	1000 (lm)	15°/30°/40°	30/90+



POLE-C

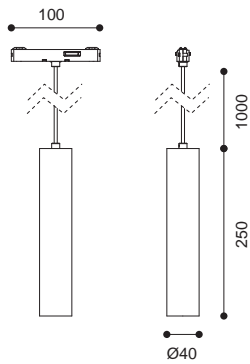

1716.100

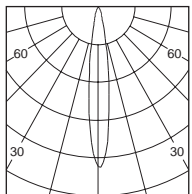

h (m)	D (m)	E (lx)
10°		
1.0	0.25	2984
2.0	0.50	746
3.0	0.75	331
4.0	1.00	186
5.0	1.25	119

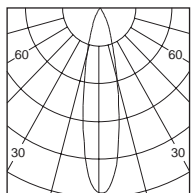

h (m)	D (m)	E (lx)
20°		
1.0	0.38	1476
2.0	0.77	369
3.0	1.16	164
4.0	1.55	92
5.0	1.94	59



- Colours Black White
- Baffle : Black White Copper

Product performance

Article number	LED Consumption	Voltage	Lumen	Beam Angle	CCT/CRI
1716.100-V	6.4W	24V DC	626 (lm)	10°/ 20°	30/90+

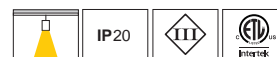

POLE-KC

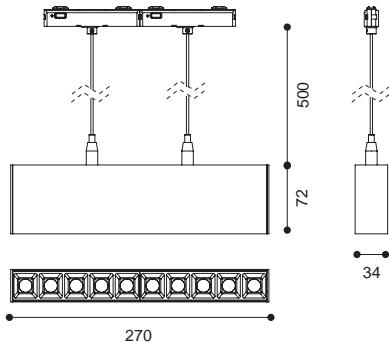

1917.401-10-V

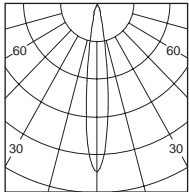

h (m)	D (m)	E (lx)
	15°	
1.0	0.26	12704
2.0	0.52	3176
3.0	0.78	1412
4.0	1.05	794
5.0	1.31	508

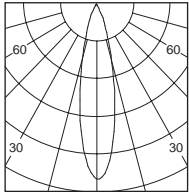

h (m)	D (m)	E (lx)
	25°	
1.0	0.40	6526
2.0	0.81	1632
3.0	1.22	725
4.0	1.62	407
5.0	2.03	261

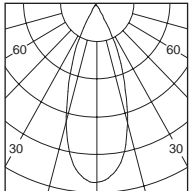

h (m)	D (m)	E (lx)
	40°	
1.0	0.68	3318
2.0	1.36	829
3.0	2.04	368
4.0	2.72	207
5.0	3.40	132



- Colours ● ○
 Black White
- Baffle : ● ○ ●
 Black White Piano black

Product performance

Article number	LED Consumption	Voltage	Lumen	Beam Angle	CCT/CRI
1917.401-10-V	22W	24V DC	2000 (lm)	15°/25°/40°	30/90+

