



OZMMAS-24V
system



OZMMAS-24V

Innovative design of ultra-micro structure, there are designs for recessed, ceilings, and pendent.

They adopt micro-shaped and exquisite magnetic designs.

Because they are very easy to install.

They can be easily and quickly adjusted according to various professional lighting standards to meet the needs of lighting design.

Suitable for a variety of professional lighting solutions including widely used in luxury chain counter lighting, window lighting, exhibition lighting, hospitality, home lighting, etc.

The ultimate solution



ETL pending

OZMMAS-24V

OZMMAS-24V TRACK

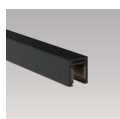

OZT-01

Surface Mounted

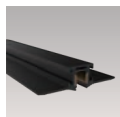

OZR-01

Recessed Trimless

(Not available in North America)



OZT-02















Pendant



OZT-03

Pendant

OZMMAS-24V MODULES

		Series name	LED Consumption	Lumen
		OZMMAS-P	4.3W 8.7W 13W	146 (lm) 287 (lm) 448 (lm)
		OZMMAS-S1	1W	90 (lm)
		OZMMAS-S2	2W	140 (lm)
		OZMMAS-S3	3W	210 (lm)
		OZMMAS-S3 (Framing)	2.3W	164 (lm)
		OZMMAS-S4	6.5W	668 (lm)
		OZMMAS-S4 (Zoomable)	6.5W	317 (lm)



OZMMAS-24V mini track system

Thanks to the exquisite structure of the 11 mm track design, the OZMMAS series has strong capabilities to fit into stenosis space. Its magnetic adaptor provides a convenient and prompt replacement module. The best solution for the showcase, shelf, niche, etc.



OZMMAS-24V





OZMMAS-24V diversity installation

The track for the OZMMAS series has multi-type functions. Such as surface mounted, recessed trimless, pendant, and top-down pendant type. Furthermore, the track has three default lengths, 1 M, 1.5 M, and 2 M, for the choice. What's even more pleasant is the track can be cut on-site. In other words, users can customize the specific length of the track to meet various requirements.

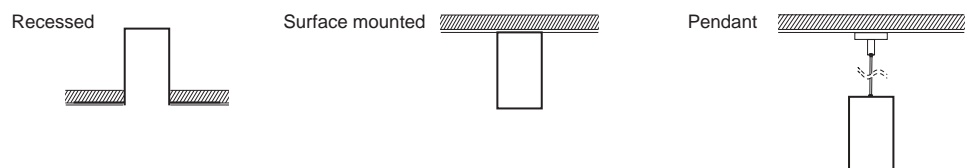

OZMMAS-24V Surface mounted system



Quickinfo

GENERAL

Surface Mounted

Recessed

ELECTRICAL

NON DIM

PHYSICAL

Aluminium

Spray powder

Panel



Spot



Description

The incredible 11 mm profile size that characterizes the program enhances the light's flexibility and its relationship with the architecture.

The surface-mounted profile track gives the architectural designer the ability to outline the most distinctive artistic expressions inside the space.

Max wattage linkable per loop for 24V, 96W, class 2 driver. (FOR U.S.)

Max wattage linkable per loop for 24V, 100W. (FOR EU)

Minimum voltage per loop is 22VDC (measure at the end of the loop),
under 22VDC per loop might cause abnormal.

Max length of track linkable per loop is 6M , and the max cable length between driver and track is 2M.

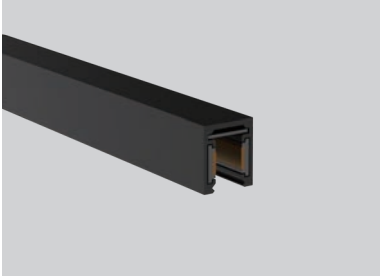

OZT-01
Surface mounter track

Colour Black ■

INSTALLATION TRACK

Article number	L (mm)	TYPE
OZT-01-1118	44" (1118mm)	Surface mounted
OZT-01-1829	72" (1829mm)	Surface mounted
OZT-01-2337	92" (2337mm)	Surface mounted

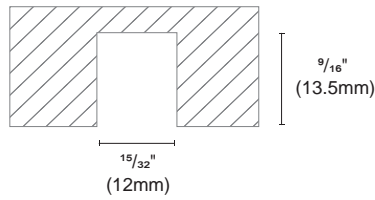
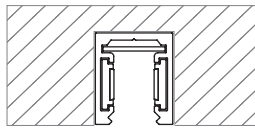
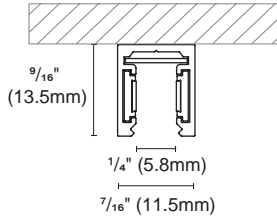

⏏ Cut out : 15/32" X 1/2" (12X13mm)

1



Article number	TYPE
OZC-02	L Circuit joint Horizontal corner



2

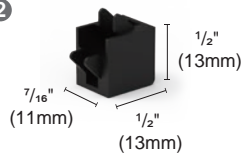



Article number	TYPE
OZC-08	Vertical corner Right angle seat





Accessories

	Article number	TYPE
	OZC-03-2000	Power joint Length : 78.74" (2000mm)

	Article number	TYPE
	OZC-04-15	Circuit joint Length : 0.59" (15mm)

	Article number	TYPE
	OZC-04-300	Circuit joint Length : 11.81" (300mm)

	Article number	TYPE
	OZC-05	I Circuit joint

	Article number	TYPE
	OZE-01-2000	Blank cover Length : 78.74" (2000mm)

	Article number	TYPE
	OZC-06	End cap

* Tail cap has break-off holes for self-trimming.



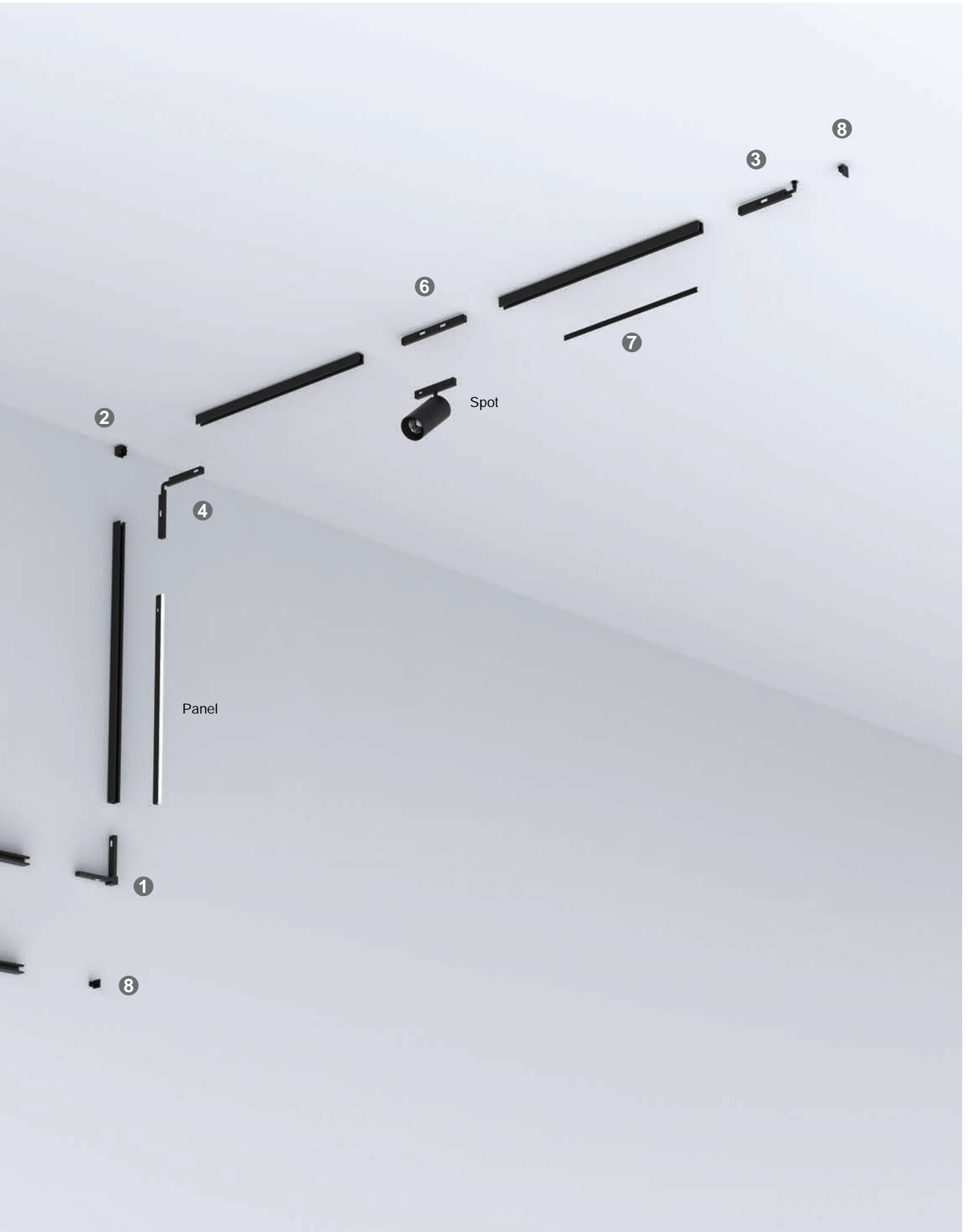

OZMMAS-24V Recessed trimless system



Quickinfo

GENERAL

Recessed Trimless

ELECTRICAL

NON DIM

PHYSICAL

Aluminium

Spray powder

Panel



Spot



Description

Surprising to the 5.8mm width of the track's inner length.

The recessed trimless track creates an extremely neat surface wherever it is installed.

Combining with the horizontal and vertical corner profiles,

this system significantly reduces the sensitivity of oppressive in the boutique area.

Exquisite, elegant, luxurious, and grandeur are its deputation.

Max wattage linkable per loop for 24V, 96W, class 2 driver. (FOR U.S.)

Max wattage linkable per loop for 24V, 100W. (FOR EU)

Minimum voltage per loop is 22VDC (measure at the end of the loop),

under 22VDC per loop might cause abnormal.

Max length of track linkable per loop is 6M , and the max cable length between driver and track is 2M.

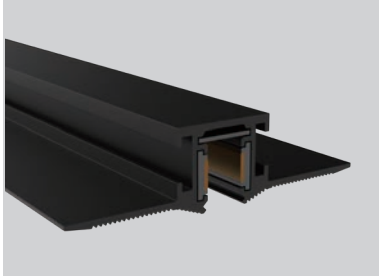

OZR-01
Recessed trimless track

Colour Black ■

INSTALLATION TRACK

Article number	L (mm)	TYPE
OZR-01-1118	44" (1118mm)	Recessed trimless
OZR-01-1829	72" (1829mm)	Recessed trimless
OZR-01-2337	92" (2337mm)	Recessed trimless

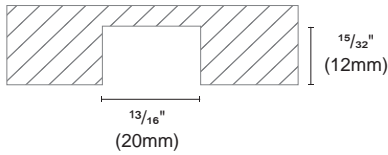
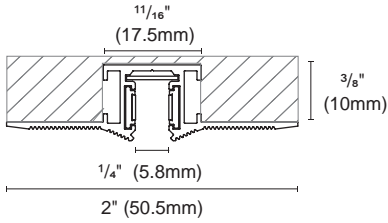

△ Cut out : 13/16" X 15/32" (20X12mm)

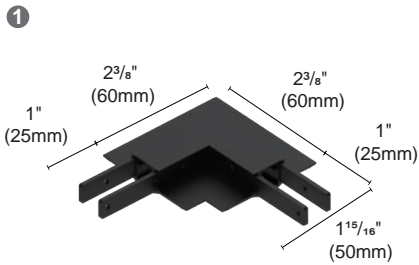

Article number	TYPE
OZ48-TL-RH	Trimless recessed horizontal corner for OZR-01 track

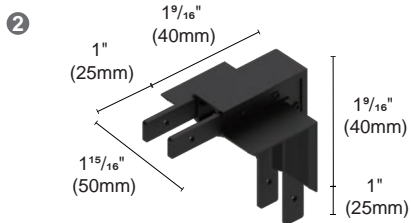
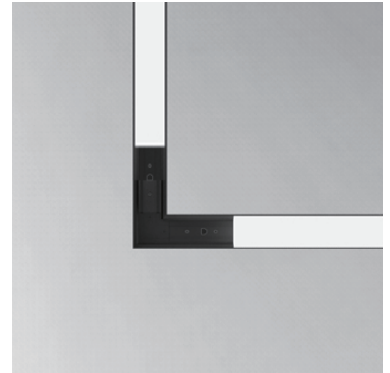

Article number	TYPE
OZ48-TL-RV	Trimless recessed vertical corner for OZR-01 track



Accessories

	Article number	TYPE
	OZC-03-2000	Power joint (For EU) Length : 78.74" (2000mm)

	Article number	TYPE
	OZC-04-15	Circuit joint Length : 0.59" (15mm)

	Article number	TYPE
	OZC-05	I Circuit joint

	Article number	TYPE
	OZE-01-2000	Blank cover Length : 78.74" (2000mm)

	Article number	TYPE
	OZC-06	End cap

	Article number	TYPE
	OZC-07-2	Reinforced joint (2 Pieces)

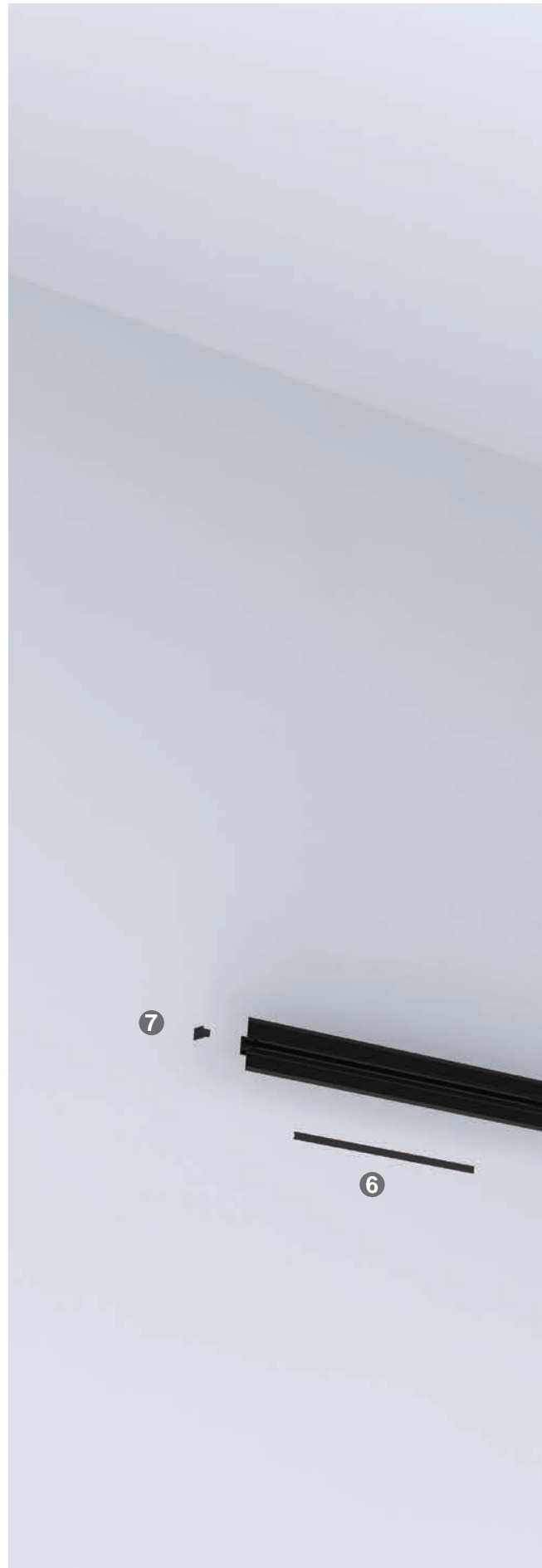



OZMMAS-24V Pendant system



Quickinfo

GENERAL

Pendant

ELECTRICAL

NON DIM

PHYSICAL

Aluminium

Spray powder

Panel



Spot



Description

Imagine creating a 3 dimension artificial works of art floating above in the space. This pendant system provides the possibility of creativity for the users and designers.

It gets rid of the shackles of the surface, allows endless imagination and creativity to emanate from each idea endlessly.

Max wattage linkable per loop for 24V, 96W, class 2 driver. (FOR U.S.)

Max wattage linkable per loop for 24V, 100W. (FOR EU)

Minimum voltage per loop is 22VDC (measure at the end of the loop),
under 22VDC per loop might cause abnormal.

Max length of track linkable per loop is 6M , and the max cable length between driver and track is 2M.

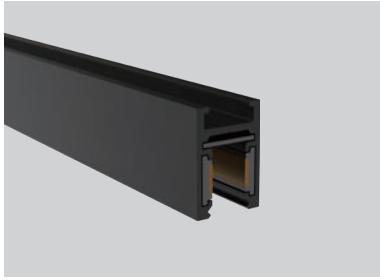

OZT-02
Pendant track

Colour Black ■

INSTALLATION TRACK

Article number	L (mm)	TYPE
OZT-02-1118	44" (1118mm)	Pendant
OZT-02-1829	72" (1829mm)	Pendant
OZT-02-2337	92" (2337mm)	Pendant

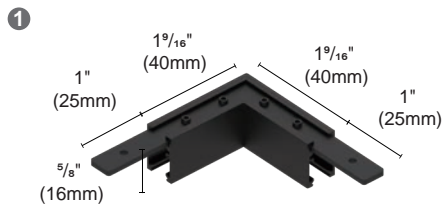
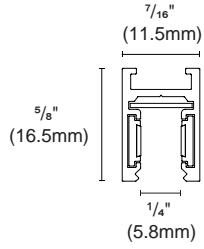

Article number	TYPE
OZ48-TP-RH	Horizontal corner for OZT-02 track



Accessories



Article number	TYPE
OZC-03-2000	Power joint Length : 78.74" (2000mm)



Article number	TYPE
OZC-04-15	Circuit joint Length : 0.59" (15mm)



Article number	TYPE
OZC-05	I Circuit joint



Article number	TYPE
OZE-01-2000	Blank cover Length : 78.74" (2000mm)



Article number	TYPE
OZC-09	End cap



Article number	TYPE
OZC-07	Reinforced joint

CEILING FASTENER / CABLE SUSPENSION



Article number	TYPE
OZI-01	Pendant Kit



Article number	TYPE
OZI-02	Pendant Kit for power connection without power cord (FOR EU)



Article number	TYPE
OZI-03	Pendant Kit for power connection without power cord (FOR US)

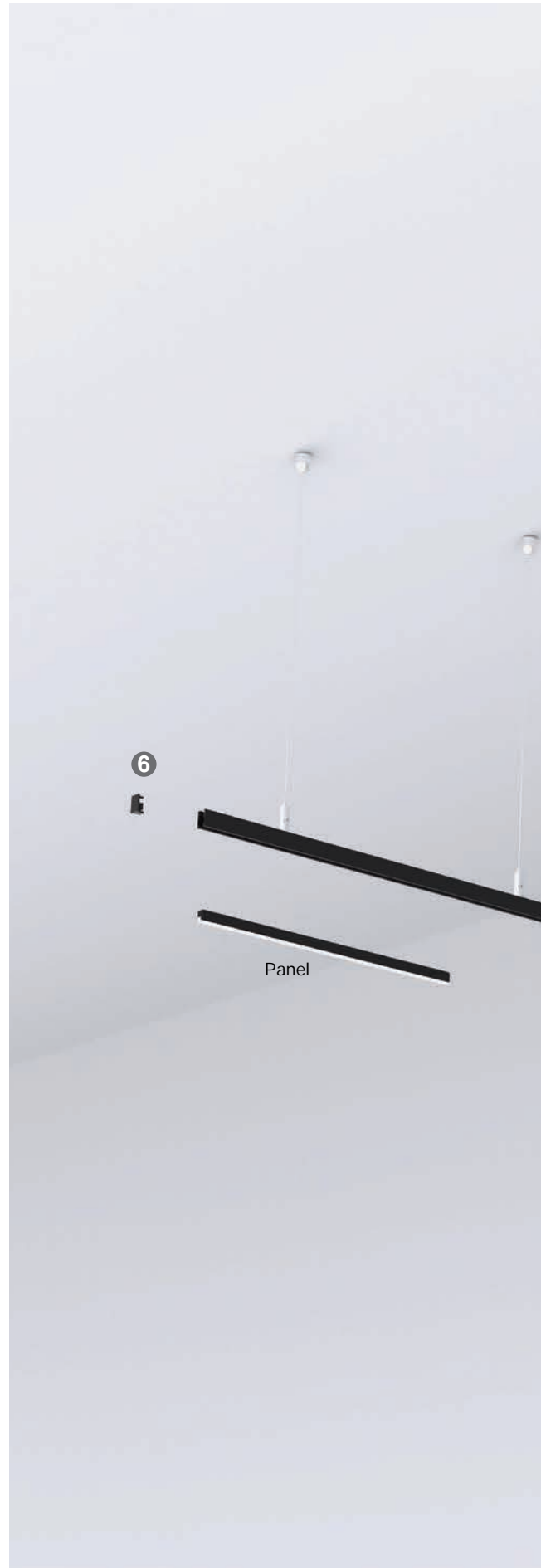

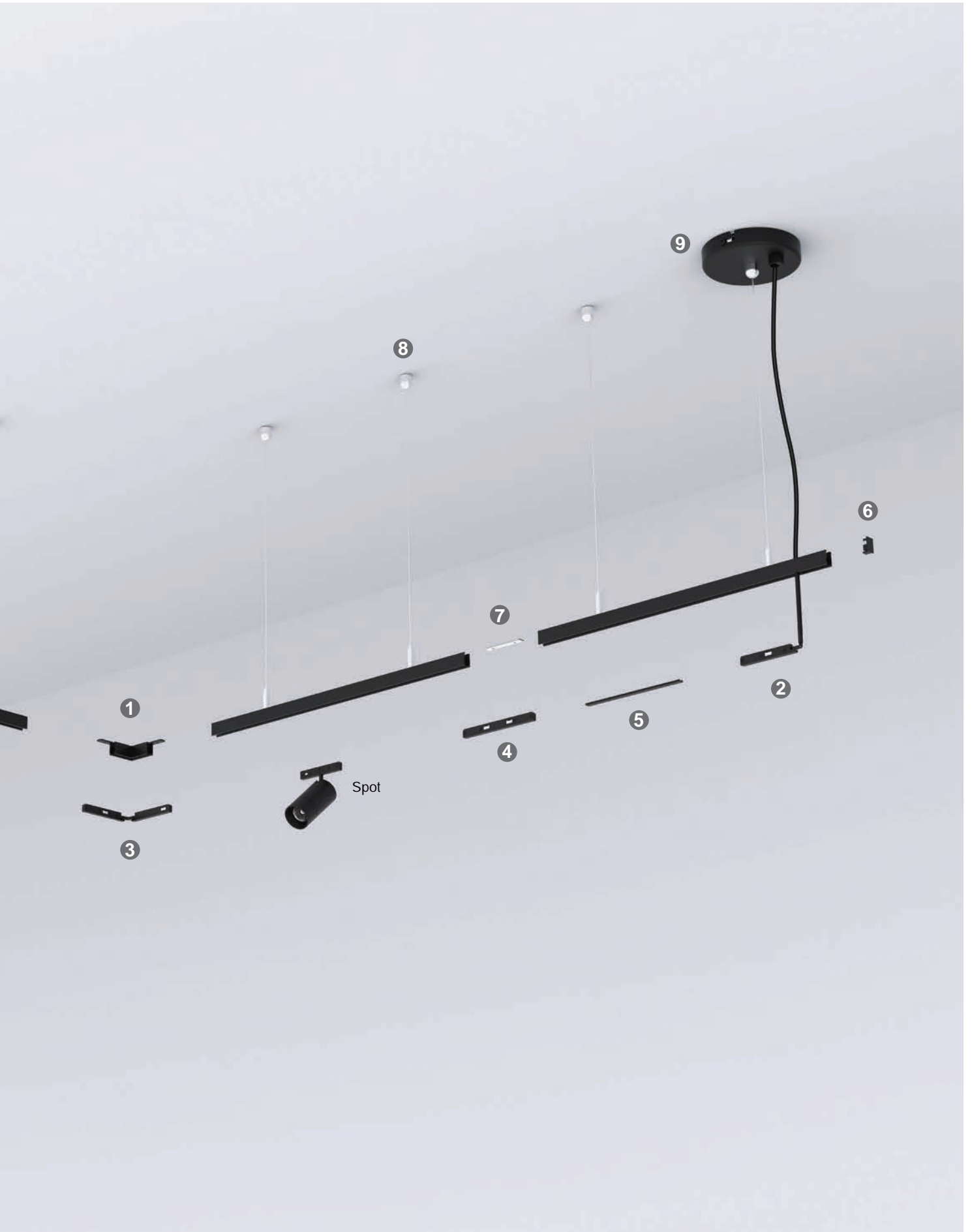

OZMMAS-24V Pendant system



Quickinfo

GENERAL

Pendant

ELECTRICAL

NON DIM

PHYSICAL

Aluminium

Spray powder

Panel



Spot



Description

Want to create an eye-catching work of art?

The OZMMAS up-down pendant system is your choice.

According to the two directions of the luminous surface, up-down pendant system gives a diverse performance in 3 dimensions.

Lights aren't just for decoration and illuminated anymore.

It becomes an eye-catching work of art for intellectual, emotional, and rational.

Max wattage linkable per loop for 24V, 96W, class 2 driver. (FOR U.S.)

Max wattage linkable per loop for 24V, 100W. (FOR EU)

Minimum voltage per loop is 22VDC (measure at the end of the loop), under 22VDC per loop might cause abnormal.

Max length of track linkable per loop is 6M , and the max cable length between driver and track is 2M.



OZT-03
Pendant track up and down

Colour Black ■

INSTALLATION TRACK



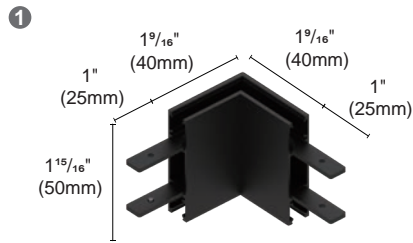
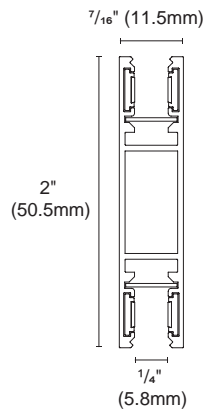







Article number	L (mm)	TYPE
OZT-03-1118	44" (1118mm)	Up-down pendant
OZT-03-1829	72" (1829mm)	Up-down pendant
OZT-03-2337	92" (2337mm)	Up-down pendant



Article number	TYPE
OZ48-TPD-RH	Horizontal corner for OZT-03 track



Accessories

	<p>Article number</p> <hr/> <p>OZC-03-2000</p> <p>TYPE</p> <hr/> <p>Power joint Length : 78.74" (2000mm)</p>
	<p>Article number</p> <hr/> <p>OZC-04-15</p> <p>TYPE</p> <hr/> <p>Circuit joint Length : 0.59" (15mm)</p>
	<p>Article number</p> <hr/> <p>OZC-04-70</p> <p>TYPE</p> <hr/> <p>Circuit joint Length : 2.76" (70mm)</p>
	<p>Article number</p> <hr/> <p>OZC-05</p> <p>TYPE</p> <hr/> <p>I Circuit joint</p>
	<p>Article number</p> <hr/> <p>OZE-01-2000</p> <p>TYPE</p> <hr/> <p>Blank cover Length : 78.74" (2000mm)</p>
	<p>Article number</p> <hr/> <p>OZC-10</p> <p>TYPE</p> <hr/> <p>End cap</p>
	<p>Article number</p> <hr/> <p>OZC-07-2</p> <p>TYPE</p> <hr/> <p>Reinforced joint (2 Pieces)</p>
<p>CEILING FASTENER / CABLE SUSPENSION</p>	
	<p>Article number</p> <hr/> <p>OZI-04</p> <p>TYPE</p> <hr/> <p>Pendant Kit</p>
	<p>Article number</p> <hr/> <p>OZI-05</p> <p>TYPE</p> <hr/> <p>Pendant Kit for power connection without power cord (FOR EU)</p>
	<p>Article number</p> <hr/> <p>OZI-06</p> <p>TYPE</p> <hr/> <p>Pendant Kit for power connection without power cord (FOR U.S.)</p>

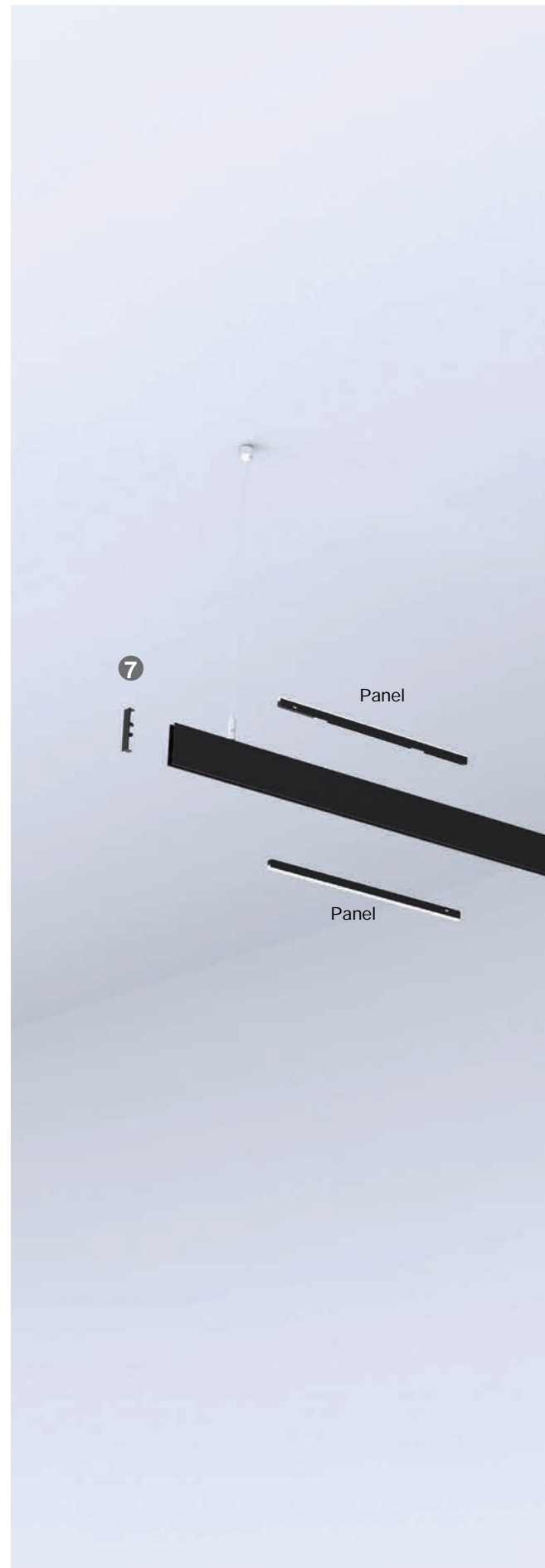

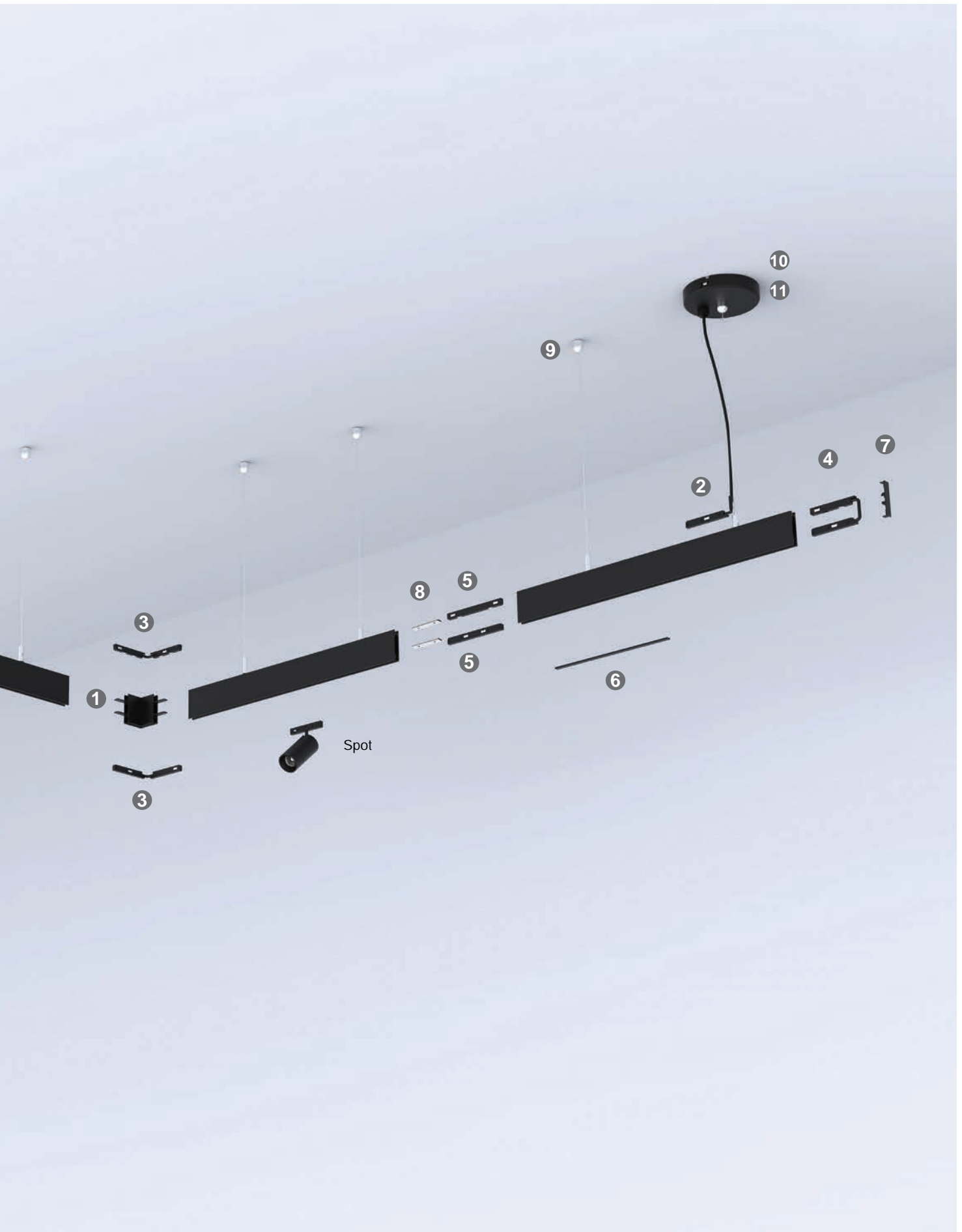



Installation method 1

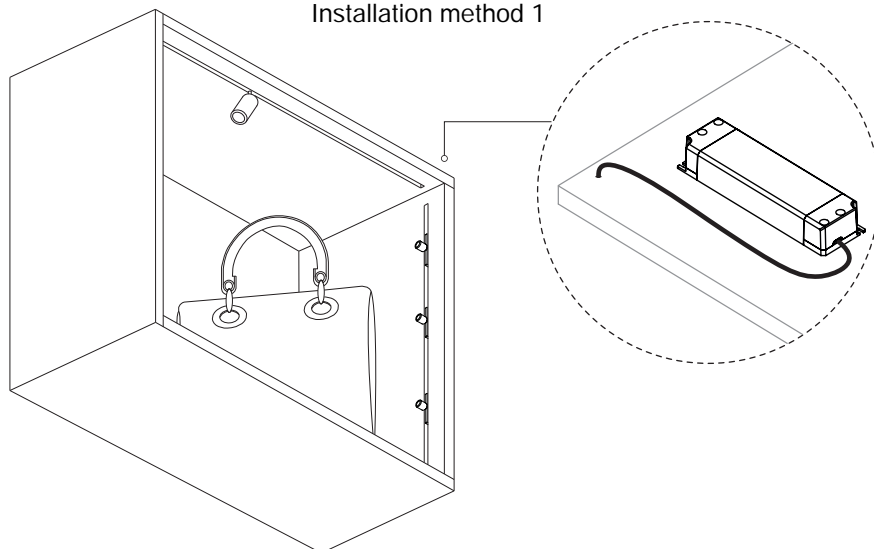



Installation method 2

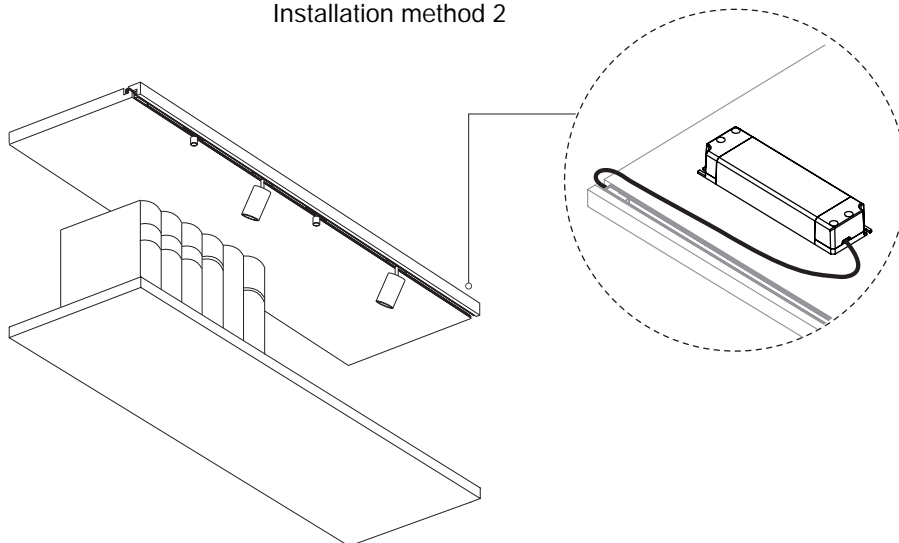

OZMMAS-24V Display system



Quickinfo

GENERAL

Recessed

ELECTRICAL

NON DIM

PHYSICAL

Aluminium

Spray powder

Panel



Spot



Description

The ceiling, wall, and shelf aren't the limitations of the OZMMAS series.

The showcase for the shopping mall and museum also can be lit up by the OZMMAS.

Its ultimate performance lets any product be highlighted by the display system.

The featured product in the store will become an eye-catching point immediately.



OZJ-01
Stem track

Colour Black ■

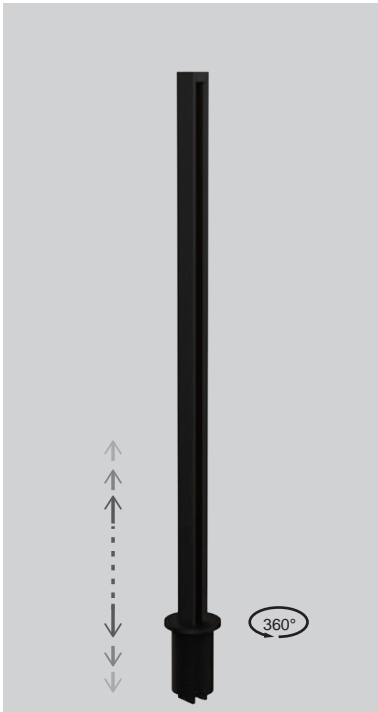

INSTALLATION TRACK

Article number	L (mm)	TYPE
OZJ-01-500	19.69" (500mm)	Stem

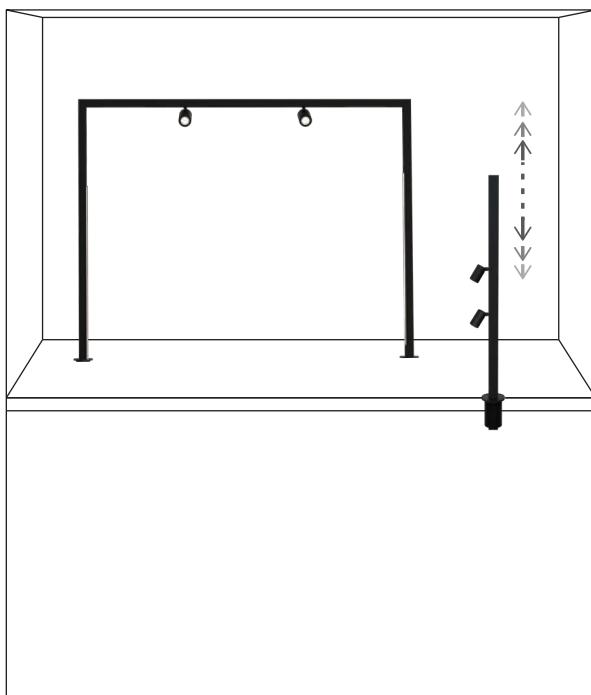
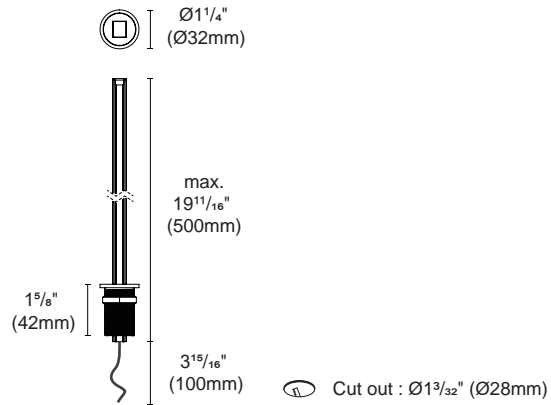

Article number	TYPE
OZ48-TS-RV	vertical corner for OZT-01 track

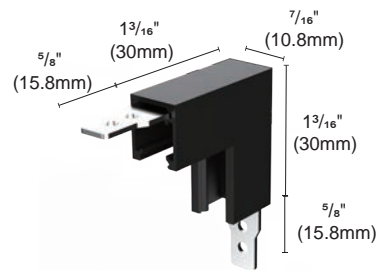

OZMMAS-24V

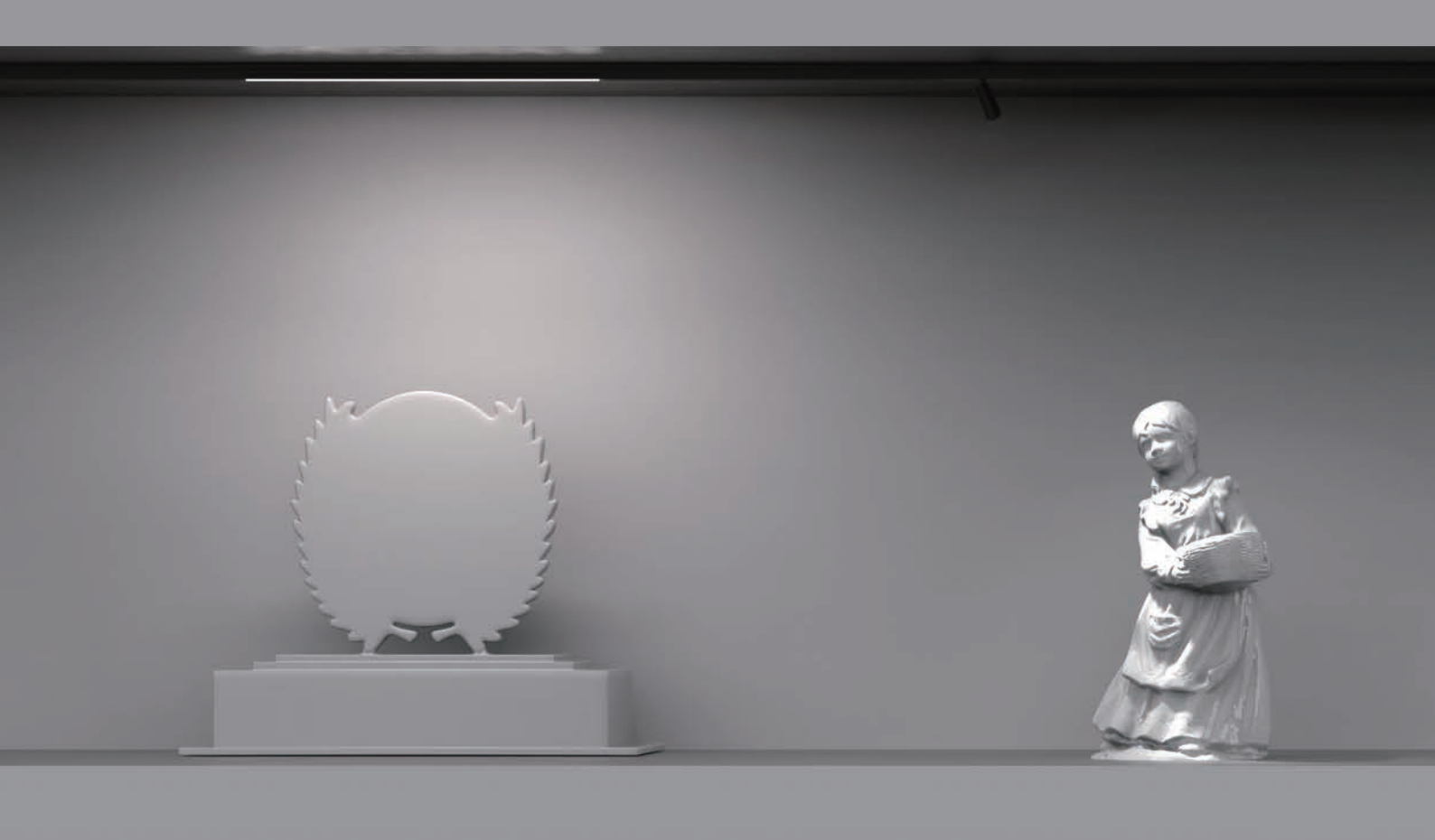

Panel 4.3w/8.7w/13w

Fully integrated linear micro-profile featuring an opal diffuser screen, perfect for creating soft, diffused lighting effects.

Spot Ø13mm 1.2w

This spotlight is compact and perfect for areas requiring small light sources, such as display cases and jewelry showcases. Despite its low power, its LED technology provides excellent light efficiency and brightness, making it ideal for highlighting product details and creating a soft lighting ambiance.

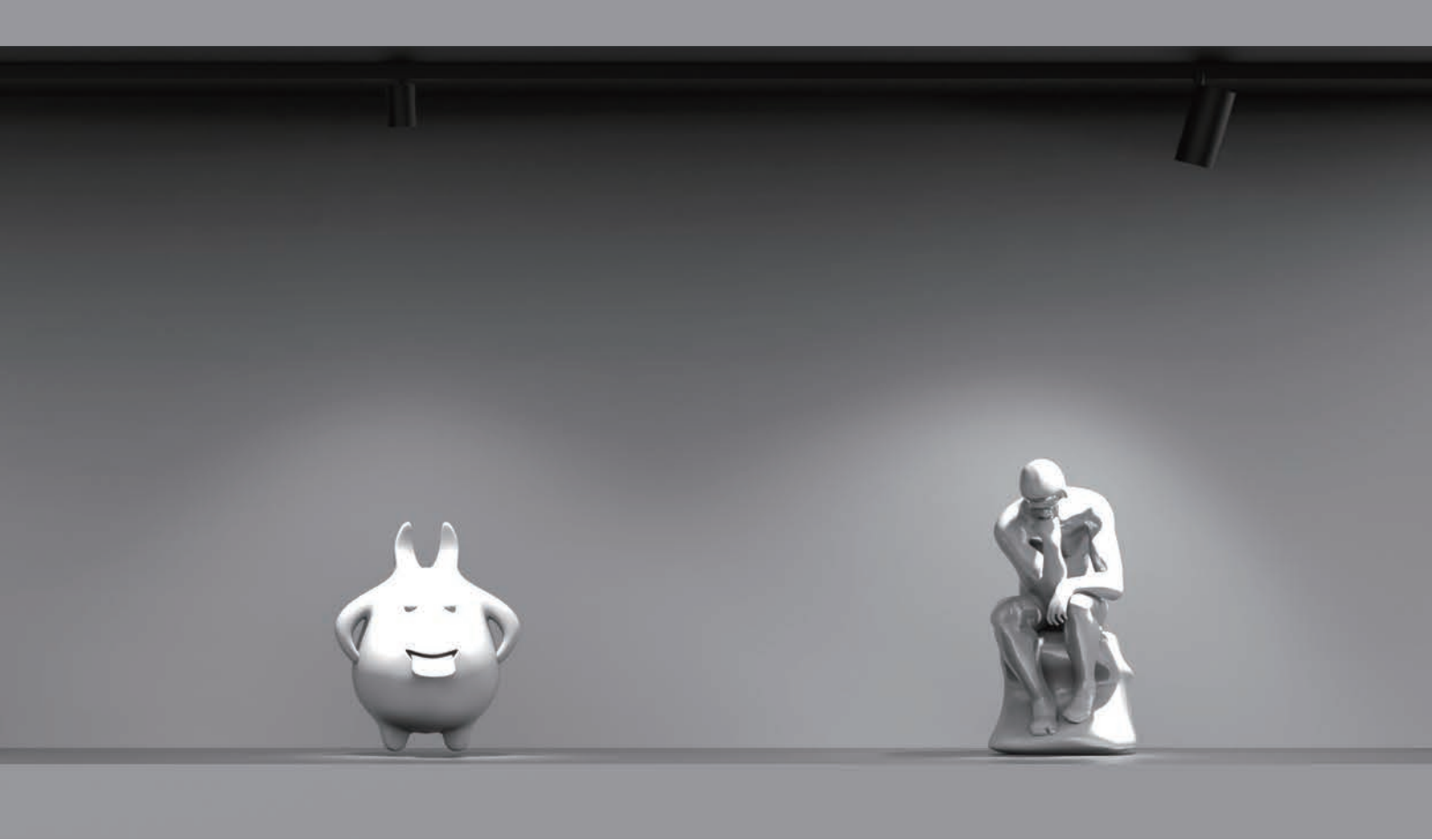

Spot

Ø24mm 2.6w

Ø23mm 2.3w (Framing)

This spotlight combines high performance with low energy consumption, making it an ideal choice for retail and exhibition applications. Its powerful light output can highlight key details of displayed items while maintaining energy efficiency. Flexible installation options allow it to easily integrate into various display environments.

Spot

Ø33mm 6.5w (Dimming) / (Zoomable+Dimming)

This spotlight features a powerful beam and high brightness, designed for display environments that require high light intensity. Whether in museums, galleries, or retail spaces, this spotlight delivers exceptional lighting performance, highlighting every detail of displayed items and creating an impressive visual impact.

OZMMAS-P

Panel

OZ1-P1



Article number	2417.200A
Fixture Consumption	4.3W (72pcs)
Voltage	24 VDC
Delivered Lumen	134 (lm)
Beam Angle	120°
CCT	3000K
CRI	90+
Colour	Black ■



ETL pending

OZ1-P2



Article number	2417.200B
Fixture Consumption	8.7W (144pcs)
Voltage	24 VDC
Delivered Lumen	322 (lm)
Beam Angle	120°
CCT	3000K
CRI	90+
Colour	Black ■



ETL pending

OZ1-P3



Article number	2417.200C
Fixture Consumption	13W (216pcs)
Voltage	24 VDC
Delivered Lumen	485 (lm)
Beam Angle	120°
CCT	3000K
CRI	90+
Colour	Black ■



ETL pending

TRIM MODELS DIMENSIONS

2417.200A/B/C

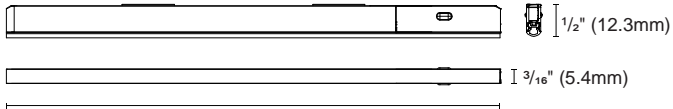

L

- 2417.200A : 11⁷/₁₆" (290mm)
- 2417.200B : 22¹³/₁₆" (580mm)
- 2417.200C : 34⁵/₈" (870mm)

 120°
2417.200A

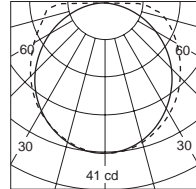
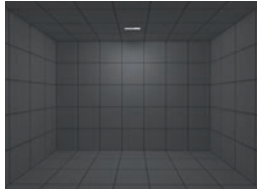

H(m)	D(m)	E(lx)
		120°
1.0	2.81	41
2.0	5.62	10
3.0	8.42	4
4.0	11.23	2
5.0	14.04	1



OZMMAS-S

Spot

OZ1-S1

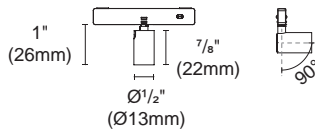

S-014-xxR
Snoot

Article number 2417.201

Fixture Consumption 1W

Voltage 24 VDC

Delivered Lumen 90 (lm)

Beam Angle 20°/25°/40° (Lens)

CCT 3000K

CRI 90+

Colour Black ■

OZ1-S2

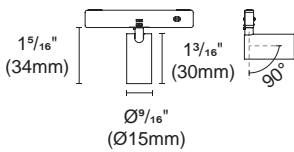

S-020
Snoot

Article number 2417.238

Fixture Consumption 2W

Voltage 24 VDC

Delivered Lumen 140 (lm)

Beam Angle 20°/30°/45° (Lens)

CCT 3000K

CRI 90+

Colour Black ■

OZ1-S3

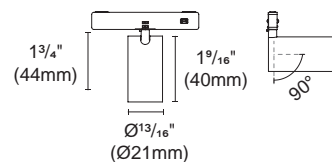

S-021
Snoot

Article number 2417.239

Fixture Consumption 3W

Voltage 24 VDC

Delivered Lumen 210 (lm)

Beam Angle 15°/25°/40° (Lens)

CCT 3000K

CRI 90+

Colour Black ■

 20°

Spot
2417.201

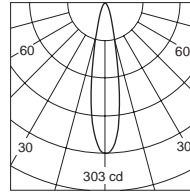
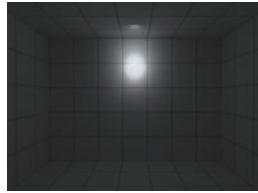

H(m)	D(m)	E(lx)
20°		
1.0	0.36	211
2.0	0.72	52
3.0	1.08	23
4.0	1.45	13
5.0	1.81	8

 25°

Spot
2417.201

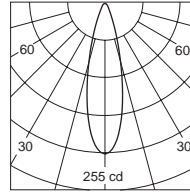
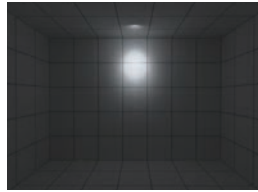

H(m)	D(m)	E(lx)
25°		
1.0	0.47	170
2.0	0.94	42
3.0	1.41	18
4.0	1.87	10
5.0	2.34	6

 40°

Spot
2417.201

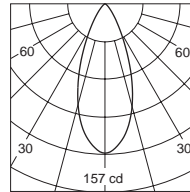
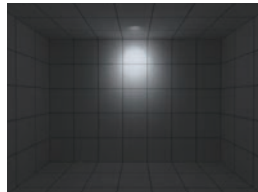

H(m)	D(m)	E(lx)
40°		
1.0	0.74	102
2.0	1.49	25
3.0	2.23	11
4.0	2.98	6
5.0	3.72	4

 20°

Spot
2417.238

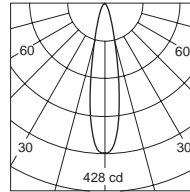
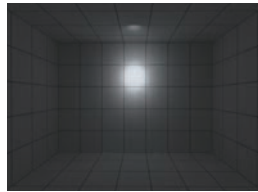

H(m)	D(m)	E(lx)
20°		
1.0	0.36	298
2.0	0.73	74
3.0	1.09	33
4.0	1.46	18
5.0	1.82	11

 30°

Spot
2417.238

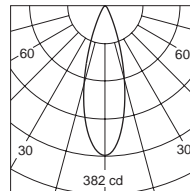
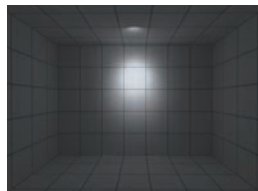

H(m)	D(m)	E(lx)
30°		
1.0	0.55	253
2.0	1.10	63
3.0	1.65	28
4.0	2.20	15
5.0	2.75	10

 45°

Spot
2417.238

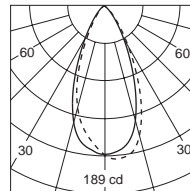
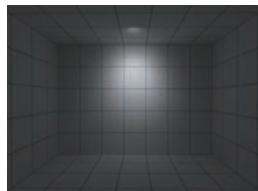

H(m)	D(m)	E(lx)
50°		
1.0	0.84	122
2.0	1.68	30
3.0	2.51	13
4.0	3.35	7
5.0	4.19	4

OZMMAS-S

Spot-Framing

OZ1-S3F

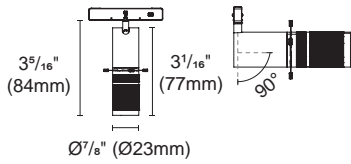

Article number	2417.206F
Fixture Consumption	2.3W
Voltage	24 VDC
Delivered Lumen	28 (lm)
Beam Angle	18° ~ 35°
CCT	3000K
CRI	90+
Colour	Black ■



CF-006-xxx
Color filter



GOBO-004-xxx.
OEM GOBO,
please contact with our sales rep for more info

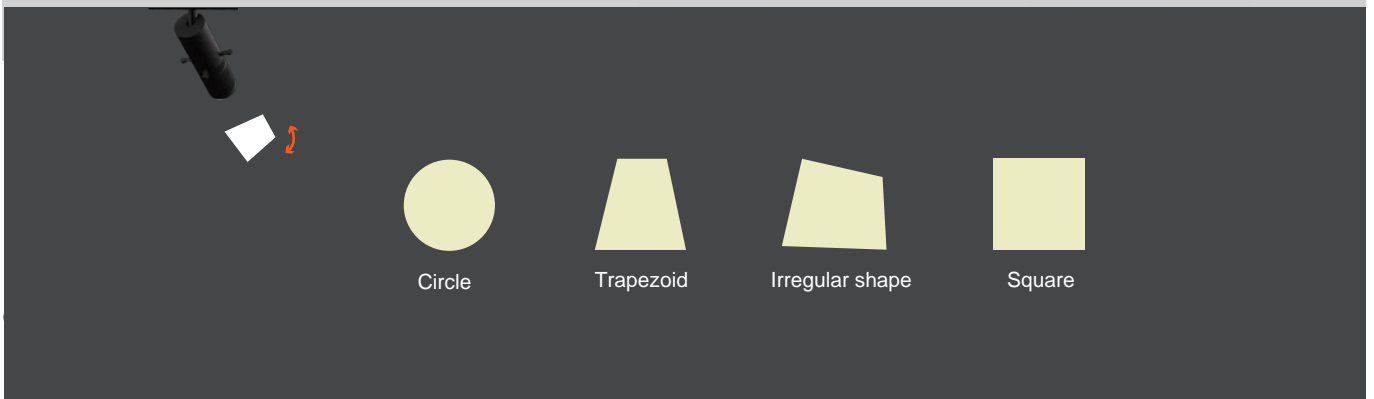
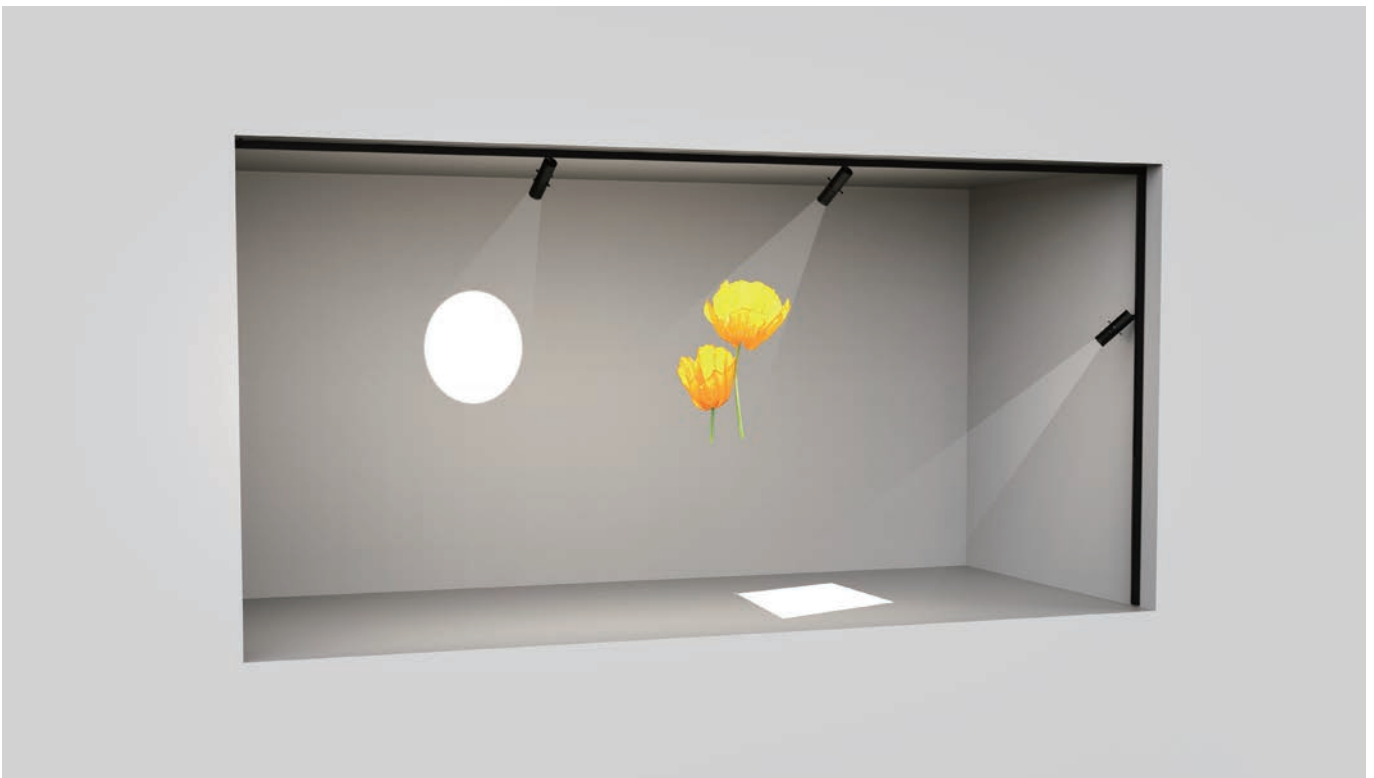



Professional-grade optical lens

Crafted with a combination of high-quality multi-layer lenses to enhance light transmission, providing high adjustability, uniform light output, and a wide zoom range.

We recommend this professional mini spotlight, specifically designed for high-end display needs. It is particularly well-suited for focusing on delicate small items, ensuring excellent illumination even for the smallest artifacts.

This light fixture features a mini track design, occupying minimal space, and can be easily adjusted without tools, adapting seamlessly to changes in the display space. It offers a vertical tilt range of 0° to 90° and a horizontal rotation capability of 355°, allowing for flexible positioning and configuration based on the display items' location and angle. Available with color filter and Customization gobo

High-precision optical components ensure clear beam outlines and high illumination uniformity, guaranteeing that every item is presented in the best possible light, drawing all attention to the exhibits themselves.

This professional mini spotlight is the ideal choice for museums, galleries, high-end retail stores, and other display spaces that require precise lighting. We believe it will provide your exhibits with outstanding illumination, allowing every piece to be showcased in its most perfect form.

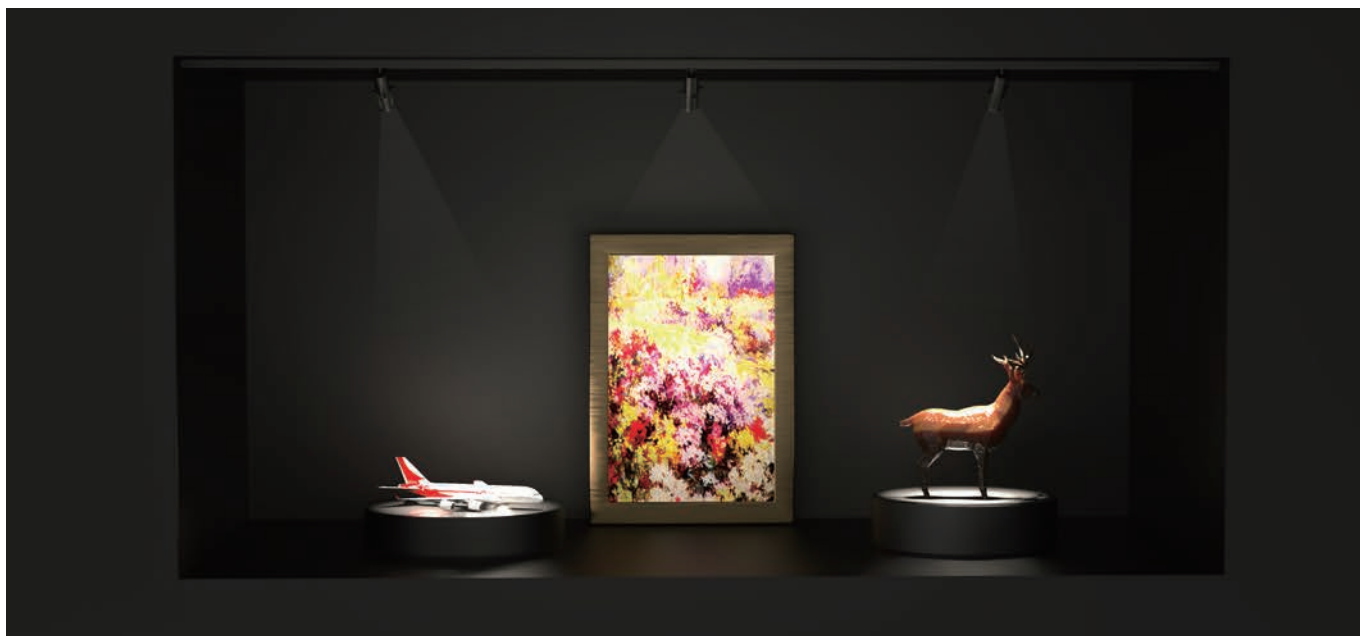

OZMMAS-S

Spot

OZ1-S4

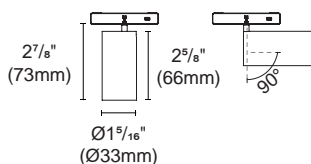

Article number	2417.203
Fixture Consumption	6.5W
Voltage	24 VDC
Lumen	799 (lm)
Delivered Lumen	668 (lm)
Beam Angle	24°/30°/40°/60° (Lens)
CCT	3000K
CRI	90+
Colour	Black ■



H-004
Honeycomb louver



DS-006
Oval filter



DS-007
Diffusers



B-001
Barndoor

* Barndoor is not suitable for vertical installation

OZ1-S4D



Dimming

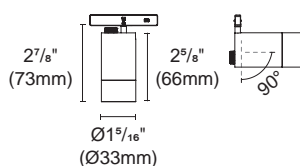

Article number	2417.205-D
Fixture Consumption	6.5W
Voltage	24 VDC
Lumen	799 (lm)
Delivered Lumen	543 (lm)
Beam Angle	24°/30°/40°/60° (Lens)
CCT	3000K
CRI	90+
Colour	Black ■



H-004
Honeycomb louver



DS-006
Oval filter



DS-007
Diffusers



B-001
Barndoor

* Barndoor is not suitable for vertical installation

OZ1-S4ZD



Zoomable

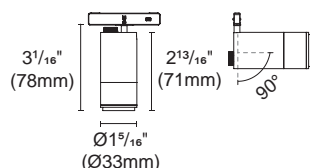

Article number	2417.205Z-D
Fixture Consumption	6.5W
Voltage	24 VDC
Lumen	799 (lm)
Delivered Lumen	317 (lm)
Beam Angle	15°-40°
CCT	3000K
CRI	90+
Colour	Black ■



 **24°**

Spotlight
2417.203
2417.205-D

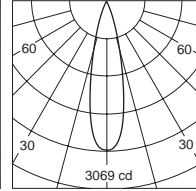
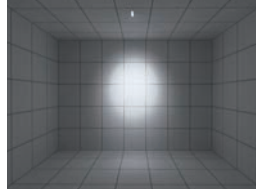

H(m)	D(m)	E(lx)
24°		
1.0	0.43	3068
2.0	0.87	767
3.0	1.30	340
4.0	1.73	191
5.0	2.17	122

 **30°**

Spotlight
2417.203
2417.205-D

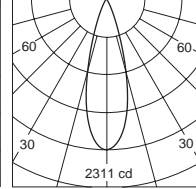
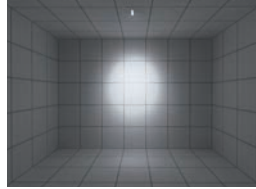

H(m)	D(m)	E(lx)
30°		
1.0	0.53	2315
2.0	1.06	578
3.0	1.58	257
4.0	2.11	144
5.0	2.64	92

 **40°**

Spotlight
2417.203
2417.205-D

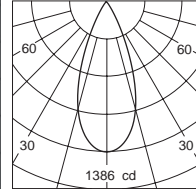
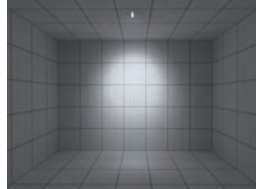

H(m)	D(m)	E(lx)
40°		
1.0	0.75	1386
2.0	1.50	346
3.0	2.25	154
4.0	2.99	86
5.0	3.74	55

 **60°**

Spotlight
2417.203
2417.205-D

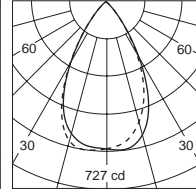
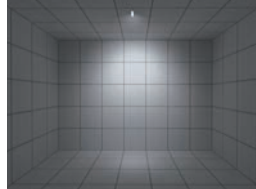

H(m)	D(m)	E(lx)
60°		
1.0	1.09	716
2.0	2.19	179
3.0	3.28	79
4.0	4.38	44
5.0	5.47	28

 **15°**

Spotlight
2417.205Z-D

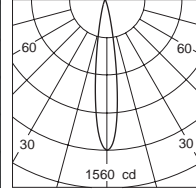
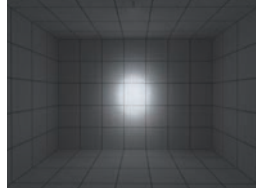

H(m)	D(m)	E(lx)
15°		
1.0	0.28	1562
2.0	0.56	390
3.0	0.84	173
4.0	1.13	97
5.0	1.41	62

 **40°**

Spotlight
2417.205Z-D

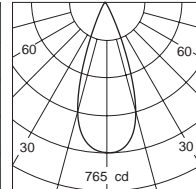
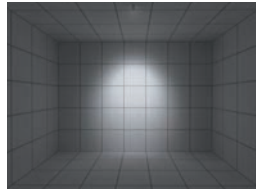

H(m)	D(m)	E(lx)
40°		
1.0	0.69	764
2.0	1.39	191
3.0	2.08	84
4.0	2.78	47
5.0	3.47	30



LD100L-VU42024-58
Type: Driver
I/P: 100 - 240VAC
O/P: 0~4.2A / 24V / 100W
Dimming: non dimmable
CE / UL



KVE-24096-TMWJ-BA
Type: Driver with gear box
I/P: 100 - 277VAC
O/P: 4A / 24V / 96W
Dimming: Triac/Phase,0/1-10V.Potentiometer
(*Note:OZMMAS-24V is non dimmable system)
CE / UL / FCC