

STAR SERIES

(AM-C.V.)
UL-1598



STAR (AM)

Small enough to be held by 2 fingers easily. Which is small and compact for blending into the ceiling perfectly, High Lumen and did not even notice the small lighting fixture in the ceiling. With a unique anti-glare feature to present soft and comfortable light emission providing UGR<19. It can apply to numerous situations, such as residential and commercial lighting.

Shape
(Baffle Size)



Round
1.5"

Square
1.5"

2 lamp
1.5"

Mountings



Recessed
Trim

Recessed
Trimless

Light distributions



Fixed

Adjustable

Wallwash

STAR-1.5"

recessed downlights



LEA-33A-HE



Fixed



Adjustable



Wallwash

Round

Trim



Trimless



Square

Trim



Trimless



Multiple lights

2 Lamp
Trim





STAR-1.5"

RISE's STAR-1.5" deliver high lumens to your spaces while remaining fully workable from below the ceiling plane.

FEATURES

- STAR-1.5" downlight offer a tiny new form element for a minutest downlight artistic.
- Industry leading luminescence and craftsmanship

Cut-off angle

Visual Comfort with Low Glare

Designed with a 36° cut-off angle, the fixture effectively blocks excess light and prevents direct glare into the eyes. It delivers focused yet soft illumination, making it ideal for environments where visual comfort is essential—such as retail displays, reception areas, and high-end residential spaces.

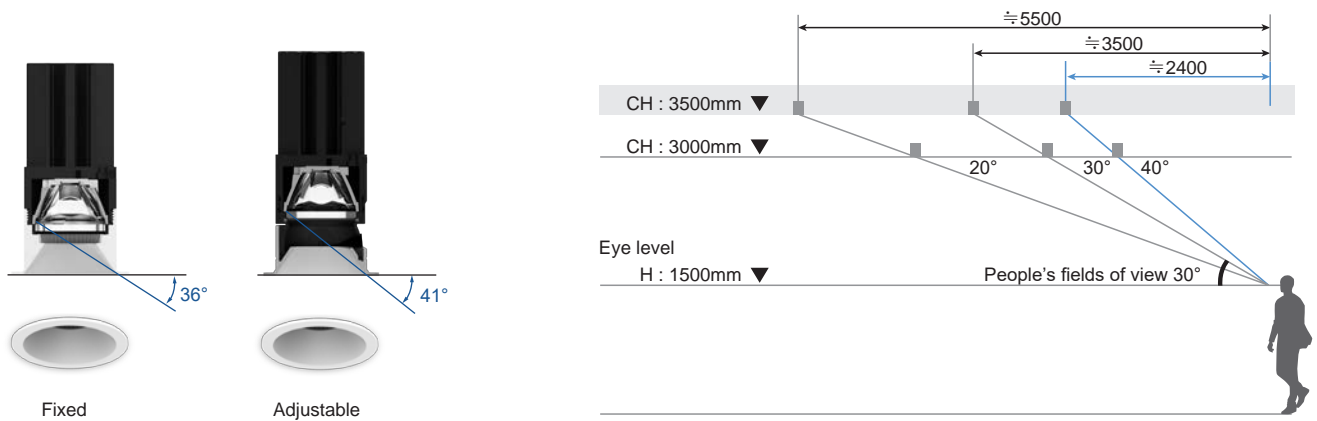

Bigger the cut-off angle, the more the visible glare is reduced





STAR-1.5" round / square
fixed / adjustable / wallwash



Specification

2700 K, 3000 K, 4000 K,
CRI ≥ 90

TRIAC, 1-10V

Types (round & square)

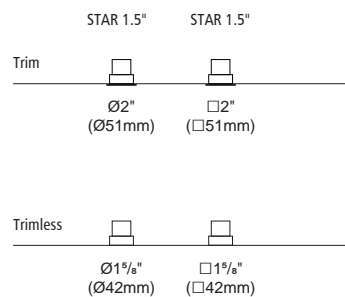



Colours

- Bezel : ● Black ○ White
- Baffle : ● Black ○ White

- Wallwash baffle : ● Black ○ White
- 

Beam Angle

- 
- 20°/25°/35°/50° (Lens)
- 
- Wallwash (Lens)



STAR-1.5-RTF



Article number	2118.564-LEA-33A-HE	
	NON-IC	IC
Fixture Consumption	14W	12W
Current	300 (mA)	250 (mA)
Delivered Lumen	1216 (lm)	1025 (lm)
Beam Angle	25°/30°/45°/55° (Lens)	
CCT	3000K	
CRI	90+	
Driver Model	EULP10AT-1WPC-WS	



Dimmable

TRIAC	1-10V
-------	-------

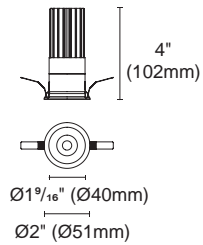

Cut out : 1²⁵/₃₂" (45mm)

STAR-1.5-RTA



Article number	2118.565-LEA-33A-HE	
	NON-IC	IC
Fixture Consumption	14W	12W
Current	300 (mA)	250 (mA)
Delivered Lumen	1148 (lm)	989 (lm)
Beam Angle	20°/30°/45°/55° (Lens)	
CCT	3000K	
CRI	90+	
Driver Model	EULP10AT-1WPC-WS	



Dimmable

TRIAC	1-10V
-------	-------

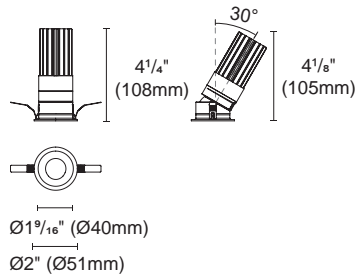

Cut out : 1²⁵/₃₂" (45mm)

STAR-1.5-RTW



Article number	2318.100-LEA-33A-HE	
	NON-IC	IC
Fixture Consumption	14W	12W
Current	300 (mA)	250 (mA)
Delivered Lumen	614(lm)	514 (lm)
Beam Angle	Wallwash (Lens)	
CCT	3000K	
CRI	90+	
Driver Model	EULP10AT-1WPC-WS	

*Wallwash lens — best optical matching angle: 15°

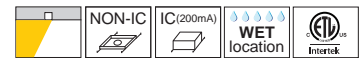

Dimmable

TRIAC	1-10V
-------	-------

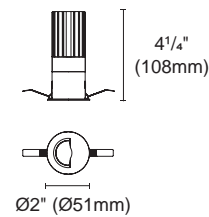

Cut out : 1²⁵/₃₂" (45mm)

Accessories

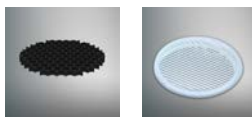

ACHO-18 honeycomb louver +PC sheet

SG-002 Striped Glass

Accessories are not suitable for wallwash fixtures

STAR-1.5-RTL



Article number	2118.659F-LEA-33A-HE	
	NON-IC	IC
Fixture Consumption	14W	12W
Current	300 (mA)	250 (mA)
Delivered Lumen	1216 (lm)	1025 (lm)
Beam Angle	25°/30°/45°/55° (Lens)	
CCT	3000K	
CRI	90+	
Driver Model	EULP10AT-1WPC-WS	



Dimmable

TRIAC	1-10V
-------	-------

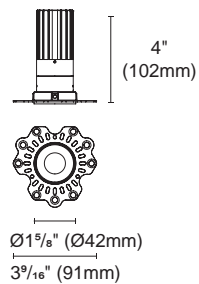

Ⓢ Cut out : 2 1/32" (54mm)

STAR-1.5-RTL

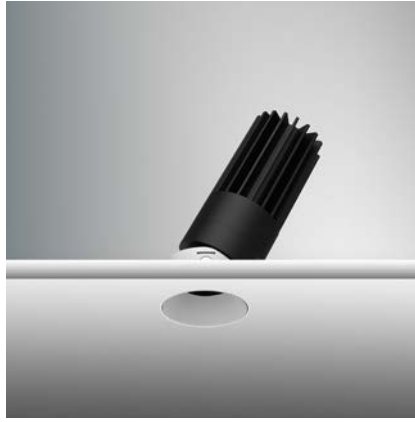

Article number	2118.660F-LEA-33A-HE	
	NON-IC	IC
Fixture Consumption	14W	12W
Current	300 (mA)	250 (mA)
Delivered Lumen	1148 (lm)	989 (lm)
Beam Angle	20°/30°/45°/55° (Lens)	
CCT	3000K	
CRI	90+	
Driver Model	EULP10AT-1WPC-WS	



Dimmable

TRIAC	1-10V
-------	-------

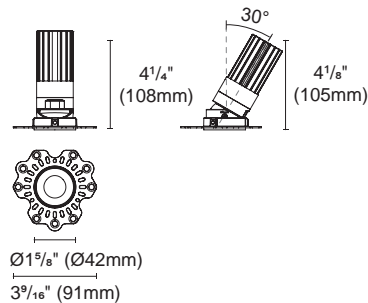

Ⓢ Cut out : 2 1/32" (54mm)

STAR-1.5-RTL



Article number	2318.200F-LEA-33A-HE	
	NON-IC	IC
Fixture Consumption	14W	12W
Current	300 (mA)	250 (mA)
Delivered Lumen	614 (lm)	514 (lm)
Beam Angle	Wallwash (Lens)	
CCT	3000K	
CRI	90+	
Driver Model	EULP10AT-1WPC-WS	

*Wallwash lens — best optical matching angle: 15°

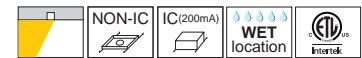

Dimmable

TRIAC	1-10V
-------	-------

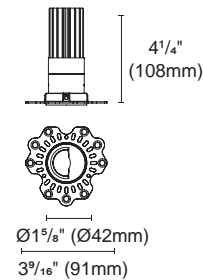

Ⓢ Cut out : 2 1/32" (54mm)

Accessories



ACHO-18 honeycomb louver +PC sheet



SG-002 Striped Glass



ACOT-107 Suction cup

Accessories are not suitable for wallwash fixtures

STAR-1.5-STF



Article number	2218.117-LEA-33A-HE	
	NON-IC	IC
Fixture Consumption	14W	12W
Current	300 (mA)	250 (mA)
Delivered Lumen	1243 (lm)	1040 (lm)
Beam Angle	25°/30°/45°/55° (Lens)	
CCT	3000K	
CRI	90+	
Driver Model	EULP10AT-1WPC-WS	



Dimmable

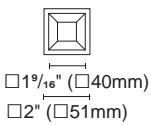
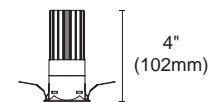
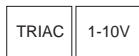

△ Cut out : 1²⁶/₃₂"X1²⁶/₃₂" (46X46mm)

STAR-1.5-STA



Article number	2218.118-LEA-33A-HE	
	NON-IC	IC
Fixture Consumption	14W	12W
Current	300 (mA)	250 (mA)
Delivered Lumen	1115 (lm)	938 (lm)
Beam Angle	20°/30°/45°/55° (Lens)	
CCT	3000K	
CRI	90+	
Driver Model	EULP10AT-1WPC-WS	



Dimmable

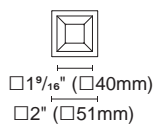
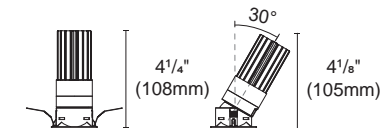

△ Cut out : 1²⁶/₃₂"X1²⁶/₃₂" (46X46mm)

STAR-1.5-STW



Article number	2318.104-LEA-33A-HE	
	NON-IC	IC
Fixture Consumption	14W	12W
Current	300 (mA)	250 (mA)
Delivered Lumen	597 (lm)	565 (lm)
Beam Angle	Wallwash (Lens)	
CCT	3000K	
CRI	90+	
Driver Model	EULP10AT-1WPC-WS	

*Wallwash lens — best optical matching angle: 15°

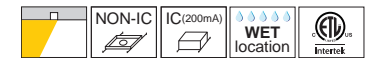

Dimmable

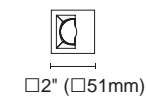
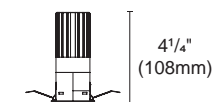

△ Cut out : 1²⁶/₃₂"X1²⁶/₃₂" (46X46mm)

Accessories



ACHO-18 honeycomb louver +PC sheet



SG-002 Striped Glass

Accessories are not suitable for wallwash fixtures

STAR-1.5-STLF



Article number	2218.208A-LEA-33A-HE	
	NON-IC	IC
Fixture Consumption	14W	12W
Current	300 (mA)	260 (mA)
Delivered Lumen	1243 (lm)	1040 (lm)
Beam Angle	25°/30°/45°/55° (Lens)	
CCT	3000K	
CRI	90+	
Driver Model	EULP10AT-1WPC-WS	



Dimmable

TRIAC	1-10V
-------	-------

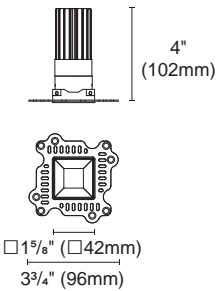

Cut out : 1³¹/₃₂"X1³¹/₃₂" (50X50mm)

STAR-1.5-STLA



Article number	2218.209A-LEA-33A-HE	
	NON-IC	IC
Fixture Consumption	14W	12W
Current	300 (mA)	250 (mA)
Delivered Lumen	1115 (lm)	938 (lm)
Beam Angle	20°/30°/45°/55° (Lens)	
CCT	3000K	
CRI	90+	
Driver Model	EULP10AT-1WPC-WS	



Dimmable

TRIAC	1-10V
-------	-------

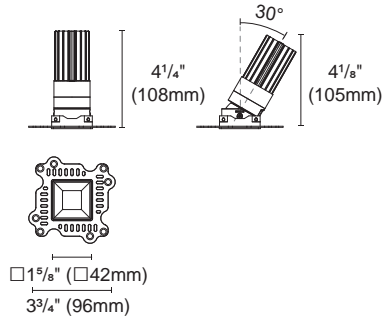

Cut out : 1³¹/₃₂"X1³¹/₃₂" (50X50mm)

STAR-1.5-STLW



Article number	2318.204A-LEA-33A-HE	
	NON-IC	IC
Fixture Consumption	14W	12 W
Current	300 (mA)	250 (mA)
Delivered Lumen	597 (lm)	565 (lm)
Beam Angle	Wallwash (Lens)	
CCT	3000K	
CRI	90+	
Driver Model	EULP10AT-1WPC-WS	

*Wallwash lens — best optical matching angle: 15°

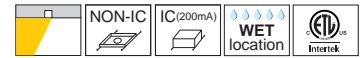

Dimmable

TRIAC	1-10V
-------	-------

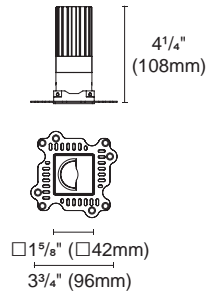

Cut out : 1³¹/₃₂"X1³¹/₃₂" (50X50mm)

Accessories

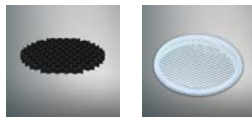

ACHO-18 honeycomb louver +PC sheet

SG-002 Striped Glass

Accessories are not suitable for wallwash fixtures

STAR-1.5" Multiple lights
fixed / adjustable / wallwash



Specification

2700 K, 3000 K, 4000 K,
CRI ≥ 90

TRIAC, 1-10V

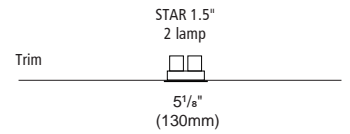

Types



Colours

Bezel :  
Black White

Baffle :

Wallwash baffle :  
Black White



Beam Angle



20°/25°/35°/50° (Lens)



Wallwash (Lens)



STAR-1.5-2-STF



Article number	2214.413-2-LEA-33A-HE	
	NON-IC	IC
Fixture Consumption	14Wx2	9.5Wx2
Current	300 (mA)X2	210 (mA)X2
Delivered Lumen	1216 (lm)X2	878 (lm)X2
Beam Angle	25°/30°/45°/55° (Lens)	
CCT	3000K	
CRI	90+	
Driver Model	EULP10AT-1WPC-WS	



Dimmable

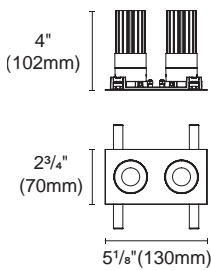

Cut out : 2¹³/₃₂"x4²⁴/₃₂" (61x121mm)

STAR-1.5-2-STA



Article number	2214.410-2-LEA-33A-HE	
	NON-IC	IC
Fixture Consumption	14Wx2	9.5Wx2
Current	300 (mA)X2	210 (mA)X2
Delivered Lumen	1148 (lm)X2	845 (lm)X2
Beam Angle	20°/30°/45°/55° (Lens)	
CCT	3000K	
CRI	90+	
Driver Model	EULP10AT-1WPC-WS	

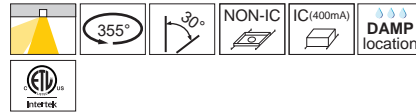

Dimmable

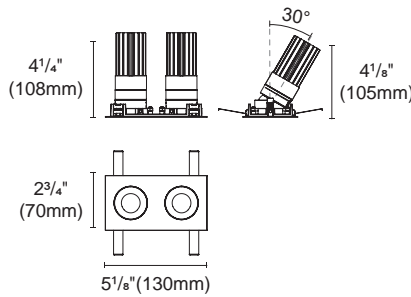

Cut out : 2¹³/₃₂"x4²⁴/₃₂" (61x121mm)

STAR-1.5-2-STW



Article number	2314.402-2-LEA-33A-HE	
	NON-IC	IC
Fixture Consumption	14Wx2	9.5Wx2
Current	300 (mA)X2	210 (mA)X2
Delivered Lumen	614 (lm)X2	439 (lm)X2
Beam Angle	Wallwash (Lens)	
CCT	3000K	
CRI	90+	
Driver Model	EULP10AT-1WPC-WS	



*Wallwash lens — best optical matching angle: 15°

Dimmable

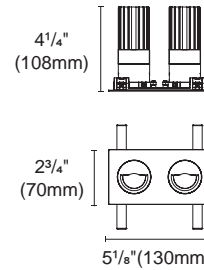

Cut out : 2¹³/₃₂"x4²⁴/₃₂" (61x121mm)

Accessories

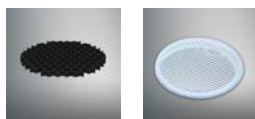

ACHO-18 honeycomb louver +PC sheet
SG-002 Striped Glass

Accessories are not suitable for wallwash fixtures



INSTALLATION OPTIONS

for Single Light

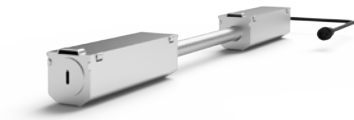

ACCG-42B-EULP10AT-1WPC-WS
 0/1-10V , TRIAC
 for STAR
 Type: NON-IC Gear box

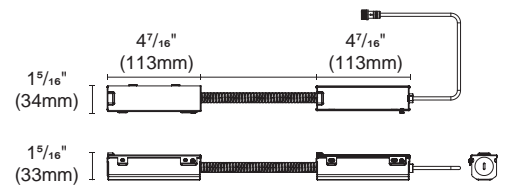

ACCH-13H-R45-S46
 for STAR round / square trim
 Type: NON-IC New construction plate

Cut out:

Round : $\varnothing 1\frac{25}{32}$ " ($\varnothing 45$ mm)

Square : $\square 1\frac{26}{32}$ " ($\square 46$ mm)

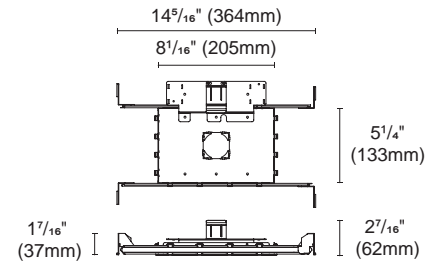

ACCH-13H-R54-S50
 for STAR round / square trimless
 Type: NON-IC New construction plate

Cut out:

Round : $\varnothing 2\frac{4}{32}$ " ($\varnothing 54$ mm)

Square : $\square 1\frac{31}{32}$ " ($\square 50$ mm)

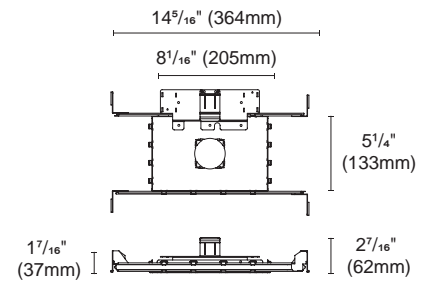

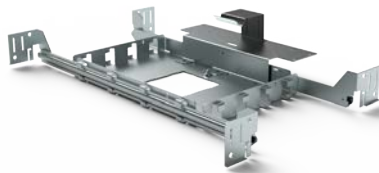

* Cutout accessories are available for different cutout dimensions

ACCH-13H-S61 + Cutout accessories
for STAR
Type: NON-IC New construction plate

Cut out:
Square : $\square 2^{13}/_{32}$ " ($\square 61$ mm)

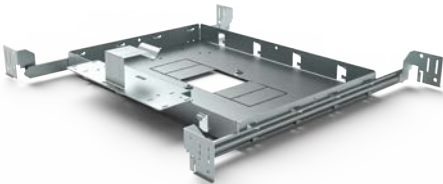
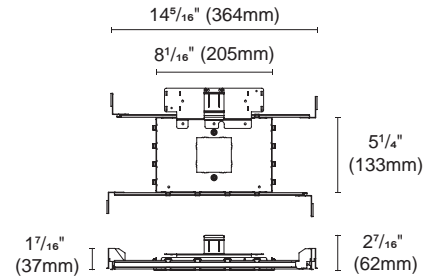

* Cutout accessories are available for different cutout dimensions

ACCH-12M-61X181 + Cutout accessories
for STAR
Type: NON-IC New construction plate

Cut out:
1 T/TL : $\square 2^{13}/_{32}$ " ($\square 61$ mm)

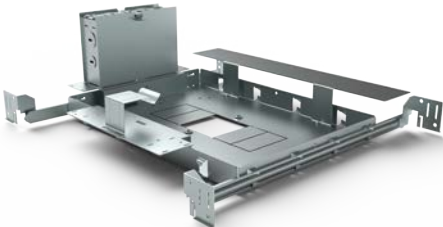
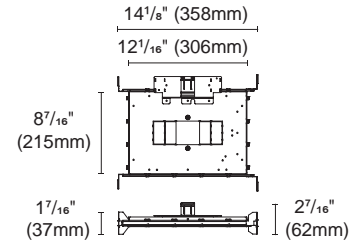

* Cutout accessories are available for different cutout dimensions

ACCH-12M-61X181-EM + Cutout accessories
for STAR
Type: Non-IC tray for emergency lighting

Cut out:
1 T/TL : $\square 2^{13}/_{32}$ " ($\square 61$ mm)

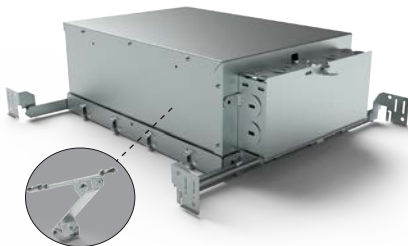
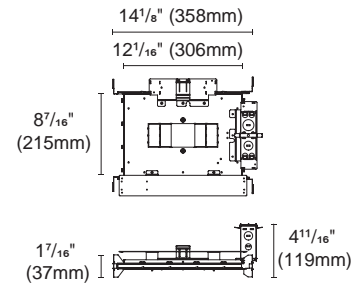

Driver is secured on patent designed bracket

ACCH-12D-S61-EULP10AT-1WPC-WS
0/1-10V , TRIAC
for STAR
Type: IC Box

* Cutout accessories are available for different cutout dimensions

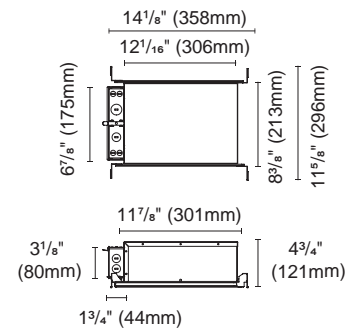

Cutout accessories

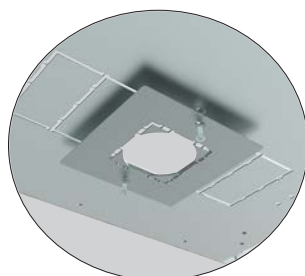

ACCI-10-R45-S46
for STAR Trim
Cut out:
Round : $\text{Ø} 1^{25}/_{32}$ " ($\text{Ø} 45$ mm)
Square : $\square 1^{26}/_{32}$ " ($\square 46$ mm)

ACCI-10-R54-S50
for STAR Trimless
Cut out:
Round : $\text{Ø} 2^{1}/_{32}$ " ($\text{Ø} 54$ mm)
Square : $\square 1^{31}/_{32}$ " ($\square 50$ mm)

INSTALLATION OPTIONS

for Multiple Lights



ACCG-30B-2-EULP10AT-1WPC-WS
0/1-10V , TRIAC
for STAR Multiple 2T
Type: NON-IC Gear box

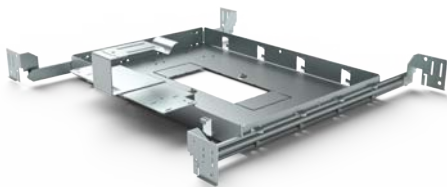
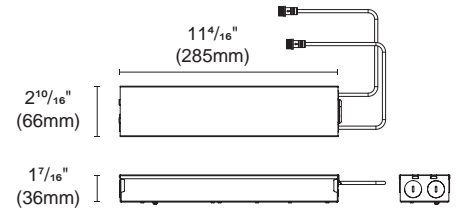

ACCH-12L-61X181
for STAR Multiple
Type: NON-IC New construction plate

Cut out:

2 T/TL : $2\frac{13}{32}" \times 4\frac{24}{32}"$ (61x121mm)

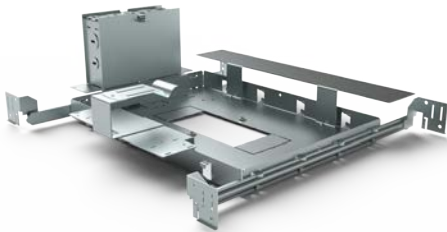
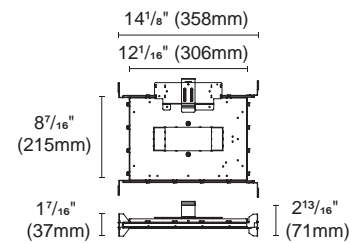

ACCH-12L-61X181-EM
for STAR Multiple
Type: NON-IC New construction plate
with emergency battery holder

Cut out:

2 T/TL : $2\frac{13}{32}" \times 4\frac{24}{32}"$ (61x121mm)

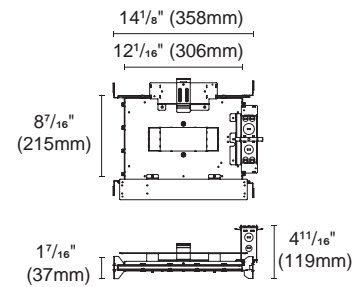

ACCH-12B-61X121-EULP10AT-1WPC-WS
0/1-10V , TRIAC
for STAR Multiple 2T
Type: IC Box

Cut out:

2 T/TL : $2\frac{13}{32}" \times 4\frac{24}{32}"$ (61x121mm)

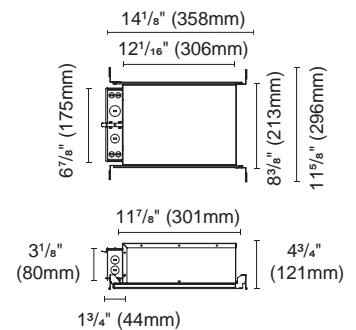

Emergency battery accessories



ACCI-3
Type: Emergency battery holder
For BillDa emergency led driver-
Model NO. BLD-HM08D-YYY

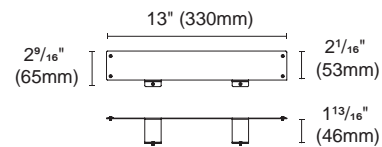

ACCI-1
Type: Junction box

