

EPIC SERIES (AM)

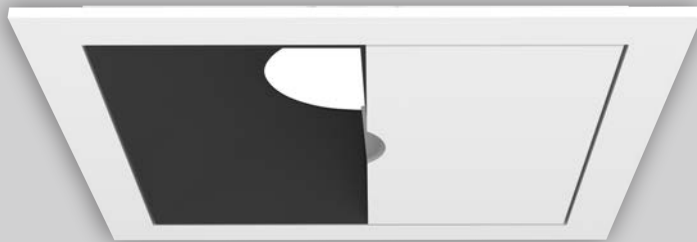

EPIC (AM)

Designed base on the concept of "light engine modularization", making EPIC series possible to be more flexible, more practical and expandable.

The features are as follows:

- * Modularized design—easy maintenance & replacement
- * Maximize common components to reduce stock cost
- * Speed up the progress of new series development in the future
- * Interchangeable design to increase product flexibility
- * Set up design norms by modularization, minimize possible faults

Shape
(Baffle size)



Round 2" Round 2.8" Round 3.5" Round 4.5"



Square 2" Square 2.8" Square 3.5" Square 4.5"

Mountings



Recessed Trim Recessed Trimless Millwork

Light distributions

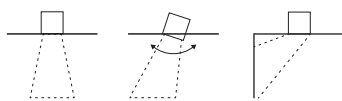

Fixed Adjustable Wallwash

EPIC
recessed downlights



LEA-13



LEA-14



LEA-14-DW
Dim To Warm
(ETL pending)

65
Fixed

65
Adjustable

85
Fixed

85
Adjustable

85
Wallwash

Round

Trim



Trimless



Millwork



Square

Trim



Trimless



Millwork





LEA-15



LEA-15-DW
Dim To Warm



ACOT-84-AM

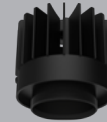

ACOT-73-AM

110
Fixed

110
Adjustable

110
Wallwash

135
Fixed

135
Adjustable

135
Wallwash

Round

Trim



Trimless



Millwork



Square

Trim



Trimless



Millwork



EPIC (AM)

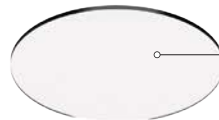

Accessories
Diffusion sheet
Striped glass
Woven glass
Honeycomb louver

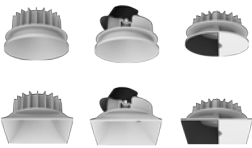
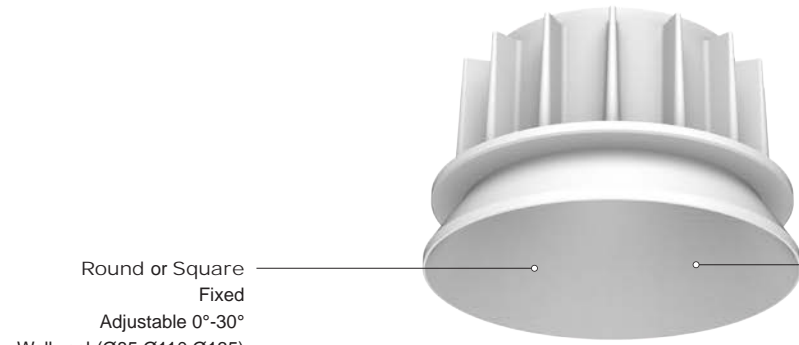

Round or Square
Trim or Trimless
Mill work

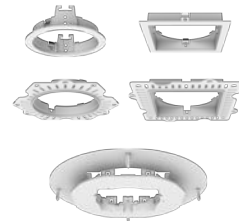



Light distributions

Three light patterns to meet all the essential functions of your lighting concept Vertical lighting is provided by downlights with different beam angles; wall-wash and floor-mounted optics provide a wide range of wall and floor lighting; adjustable spotlight settings . If the functional area changes, the optics in the luminaire housing can be easily replaced without tools.

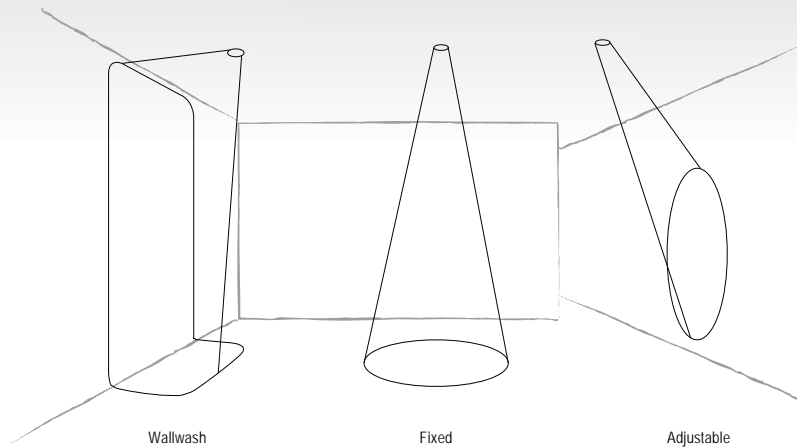

Easy installation

Easy to replace, quick to assemble and completely tool-free.



Colorful

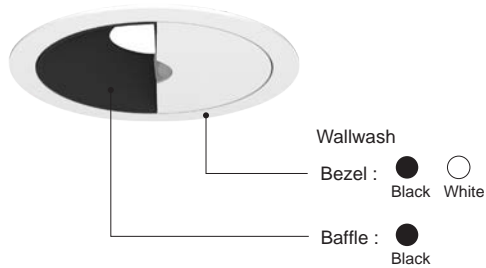
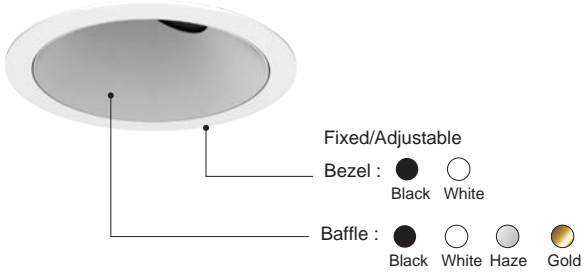

Low glare baffle

Design with 30° cut-off angle, this series ensures the low glare function that able to create a soft visual effect.

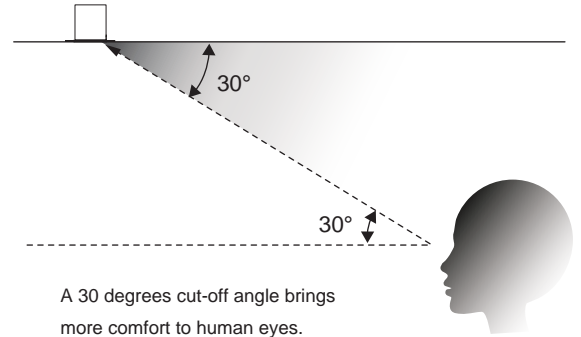

Adding an extra component to the fixture prevent people seeing through the fixture a very tender thought from our designer

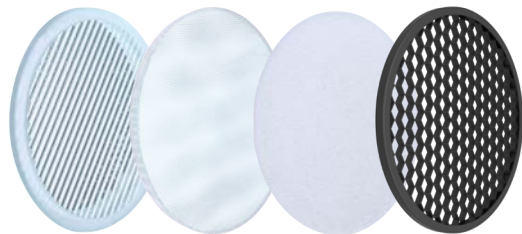
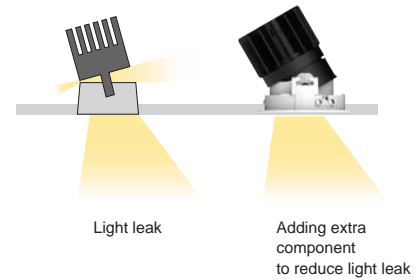

Striped glass Woven glass Diffusion sheet Honeycomb louver

With more options to the accessories, EPIC adds more flexibility and freedom for the lighting designer. Honeycomb reduces glare; strip glass creates oval distribution; diffusion sheet & woven glass soften and even spread the light.

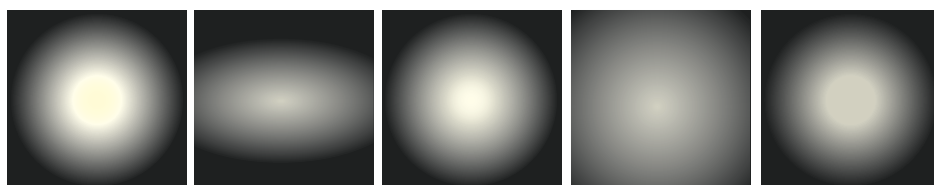

Lens (no accessory) Striped glass Woven glass Diffusion sheet Honeycomb louver

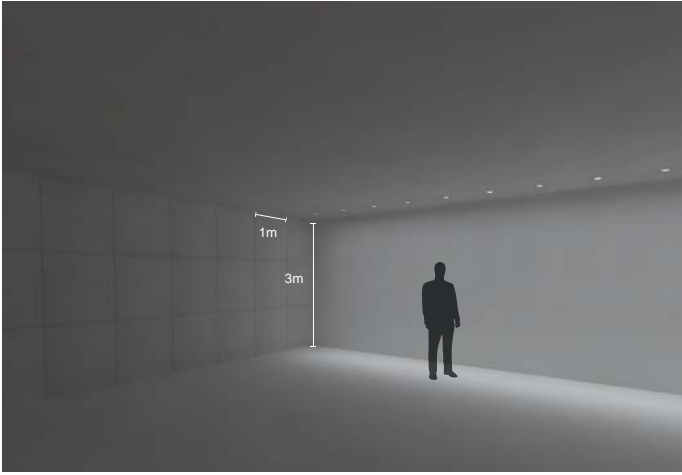

Wallwash

EPIC a wallwash enables even illumination on the target wall without shadows. It supplies an overall effect that is clean and elegant. Generally speaking, the distance between the lighting fixture and the height of the illuminated wall ranges from 1/3 to 1/5. This wallwash function; not only broadens the illumination effect with smooth lights performance but also makes the entire area feels brighter. When combining with other function fixtures together, it can form a fusion of beauty.

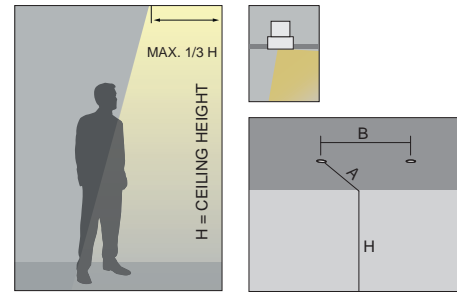
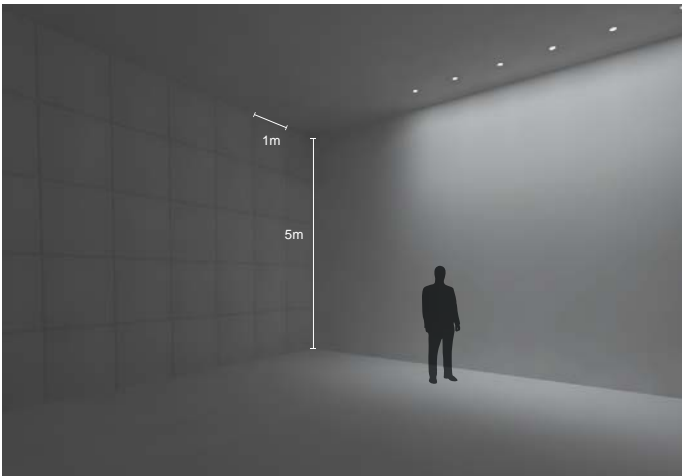

RECOMMENDED DISTANCES (Meter)	EPIC 2.8"	A : H : B	0.75 : 3 : 0.75 (m)
	EPIC 3.5"	A : H : B	0.75 : 5 : 0.75 (m)
	EPIC 4.5"	A : H : B	0.75 : 5 : 0.75 (m)



Dim to Warm 1800-3000K (for EPIC 110)

This light engine features Dim to Warm, the ultimate in dimming comfort, where the light changes its colour temperature according to the dimming curve; the darker the light, the warmer the light. Like a sunset effect, the gradual change replicates the transition from a comfortable ambience to a relaxing and soothing environment.

Dim to Warm is the term used to describe the function of LEDs to reduce the colour temperature (CCT) of the light as it dims, from 3000K at 100% to 1800K at nearly 0%.

The light provides a relaxing ambience for a typical evening dining experience, reading in bed, a moody hotel lobby or bar environment. By moving from dim to warm, we provide a light source that is alert and bright when cooking or working, then dimmed to provide a warm ambience for hosting and relaxing in the evening.



Hole size doesn't match? No worries!

Your installation "Rescue Ring" is here!

During lighting installation, one of the most frustrating issues is dealing with old ceiling cutouts that don't match the new fixture size—or when the hole was accidentally cut too large.

Now you don't need to redo the ceiling or settle for uneven gaps.

Our Goof ring is designed exactly for this situation!

One Goof ring is all you need for a perfect fit!

Whether you're reusing an existing opening or correcting a cutting mistake, this "Goof ring" ensures your lighting still looks flawless, consistent, and beautifully integrated.

Simply install the trim ring before mounting the light.

It helps you:

- Perfectly cover oversized cutouts
- Hide installation errors for a clean finish
- Blend seamlessly with your light fixture
- Install quickly—saving time and effort

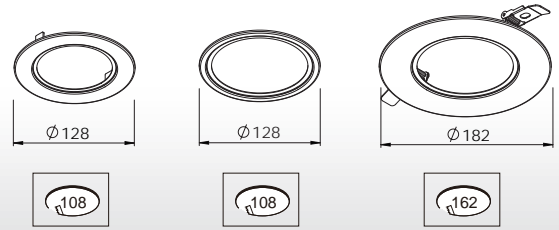

* This accessory is also compatible with various related sizes of recessed downlights.



EP85-GOOFRING-4

for 2.8"

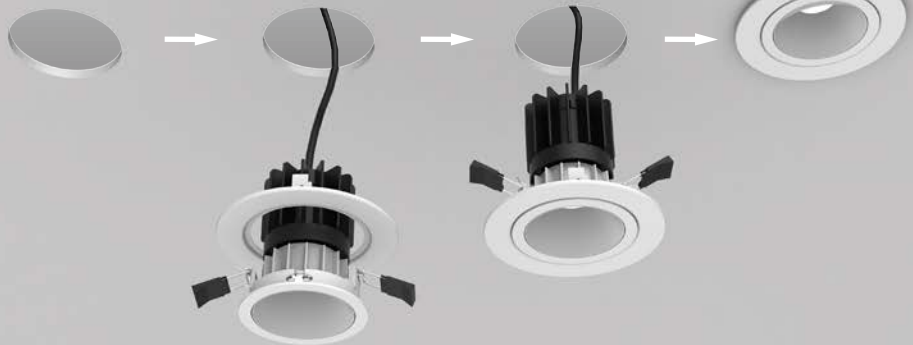

EP110-GOOFRING-4

for 3.5"

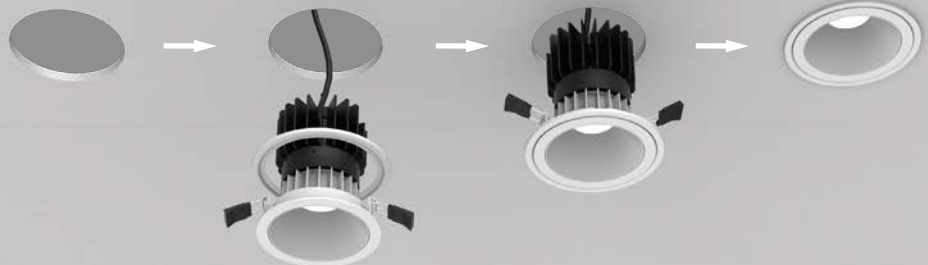

EP110-GOOFRING-6

for 3.5"

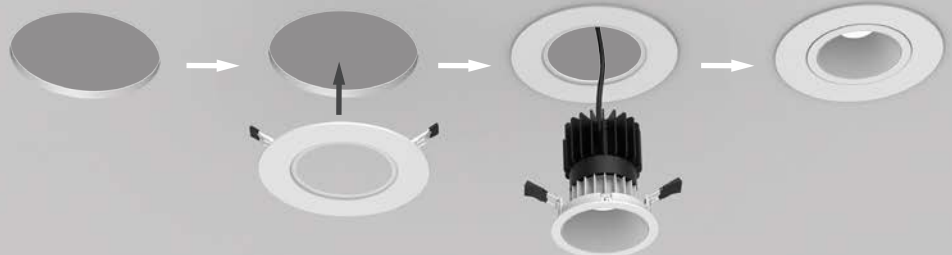

EPIC 65/85/110/135
recessed downlights

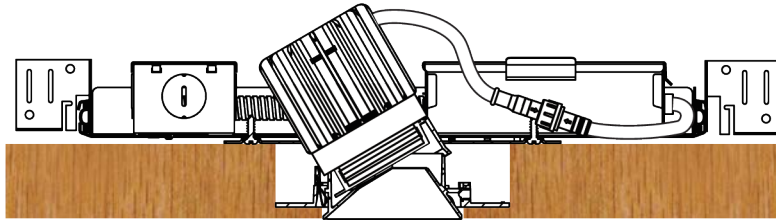

Wood Ceiling Style







B GALLERY

B GALLERY





EPIC-65

2"

Round / Square

Fixed
Adjustable

EPIC-65-RTF



Article number	2118.137-LEA-13
Fixture Consumption	12W
Current	250 (mA)
Delivered Lumen	766 (lm)
HE Delivered Lumen*	903 (lm)
Beam Angle	20°/40°/55° (Lens)
CCT	3000K
CRI	90+
Driver Model	PUP10A-1WMC-350

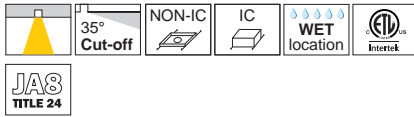

Dimmable

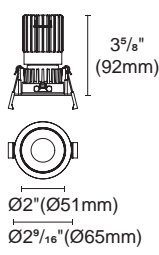

⊘ Cut out : 2 1/2" (60mm)

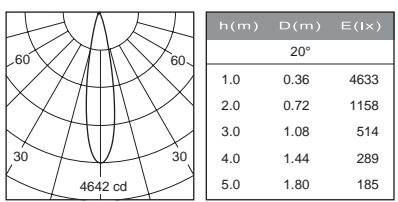

EPIC-65-RTA



Article number	2118.138-LEA-13
Fixture Consumption	12W
Current	250 (mA)
Delivered Lumen	767 (lm)
HE Delivered Lumen*	905 (lm)
Beam Angle	20°/40°/55° (Lens)
CCT	3000K
CRI	90+
Driver Model	PUP10A-1WMC-350

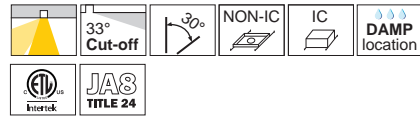

Dimmable

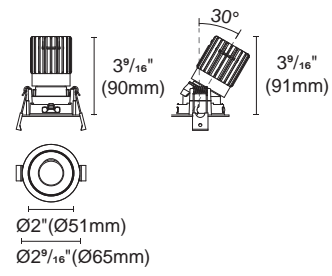

⊘ Cut out : 2 1/2" (60mm)

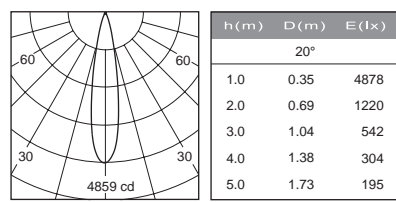

Accessories



ACSG-5 Striped PC sheet ACHO-6 Honeycomb louver ACDS-3 Diffusion sheet ACWG-6 Woven glass ACOT-107 Suction cup

EPIC-65-RTLF

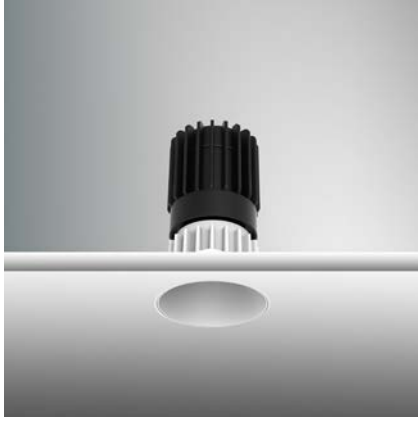

Article number	2118.237F-LEA-13
Fixture Consumption	12W
Current	250 (mA)
Delivered Lumen	766 (lm)
HE Delivered Lumen*	903 (lm)
Beam Angle	20°/40°/55° (Lens)
CCT	3000K
CRI	90+
Driver Model	PUP10A-1WMC-350

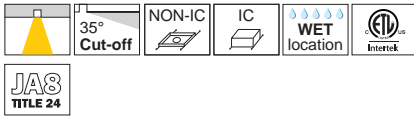

Dimmable

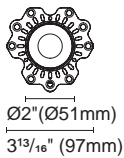
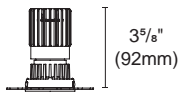

⊘ Cut out : 2 1/2" (60mm)

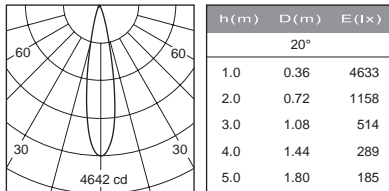

EPIC-65-RTL A

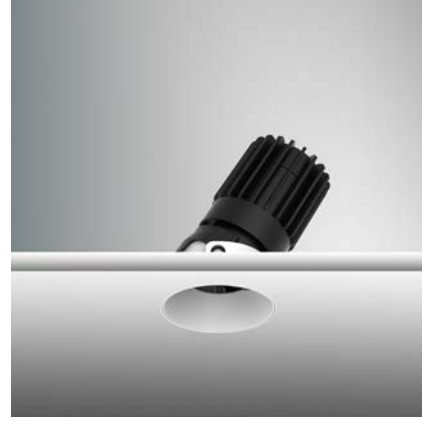

Article number	2118.238F-LEA-13
Fixture Consumption	12W
Current	250 (mA)
Delivered Lumen	767 (lm)
HE Delivered Lumen*	905 (lm)
Beam Angle	20°/40°/55° (Lens)
CCT	3000K
CRI	90+
Driver Model	PUP10A-1WMC-350

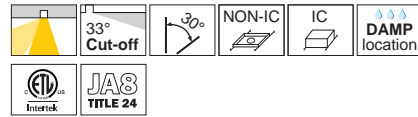

Dimmable

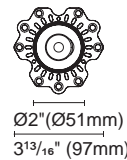
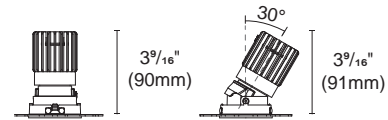

⊘ Cut out : 2 1/2" (60mm)

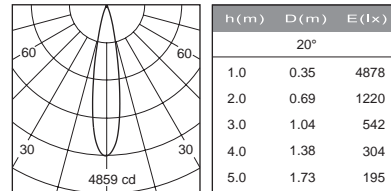

Accessories



ACSG-5
Striped PC sheet

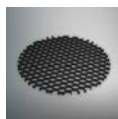

ACHO-6
Honeycomb louver



ACDS-3
Diffusion sheet



ACWG-6
Woven glass



ACOT-107
Suction cup

EPIC-65-STF

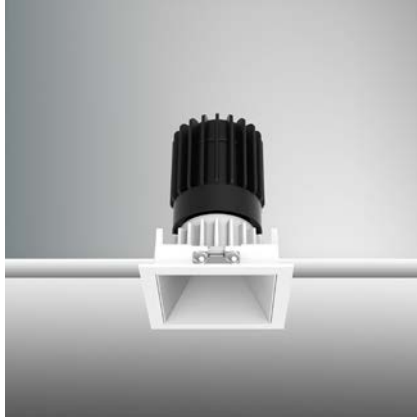

Article number	2118.140-LEA-13
Fixture Consumption	12W
Current	250 (mA)
Delivered Lumen	796 (lm)
HE Delivered Lumen*	939 (lm)
Beam Angle	20°/40°/55° (Lens)
CCT	3000K
CRI	90+
Driver Model	PUP10A-1WMC-350

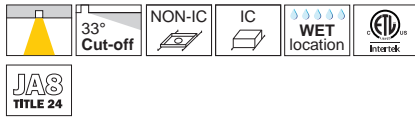

Dimmable

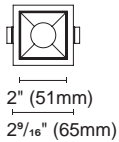
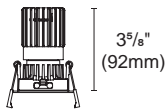

Cut out : 2 1/2\"/>

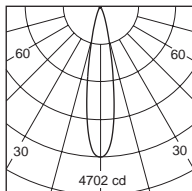

h (m)	D (m)	E (lx)
20°		
1.0	0.35	4705
2.0	0.70	1176
3.0	1.05	522
4.0	1.39	294
5.0	1.74	188

EPIC-65-STA

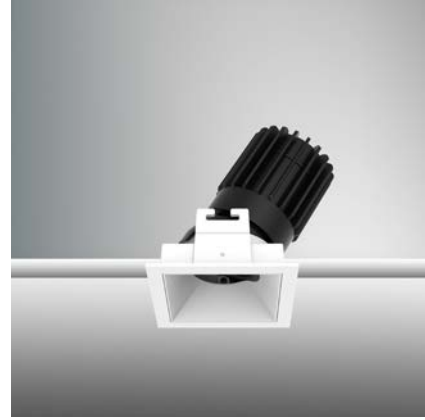

Article number	2118.141-LEA-13
Fixture Consumption	12W
Current	250 (mA)
Delivered Lumen	755 (lm)
HE Delivered Lumen*	890 (lm)
Beam Angle	20°/40°/55° (Lens)
CCT	3000K
CRI	90+
Driver Model	PUP10A-1WMC-350

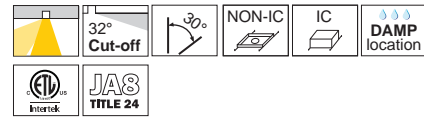

Dimmable

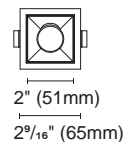
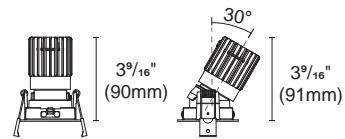

Cut out : 2 1/2\"/>

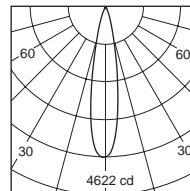

h (m)	D (m)	E (lx)
20°		
1.0	0.35	4619
2.0	0.69	1155
3.0	1.04	513
4.0	1.38	288
5.0	1.73	184

Accessories



ACSG-5 Striped PC sheet ACHO-6 Honeycomb louver ACDS-3 Diffusion sheet ACWG-6 Woven glass ACOT-107 Suction cup

EPIC-65-STLF

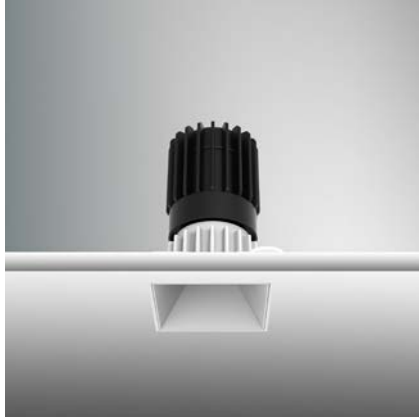

Article number	2118.240A-LEA-13
Fixture Consumption	12W
Current	250 (mA)
Delivered Lumen	796 (lm)
HE Delivered Lumen*	939 (lm)
Beam Angle	20°/40°/55° (Lens)
CCT	3000K
CRI	90+
Driver Model	PUP10A-1WMC-350

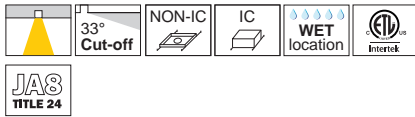

Dimmable

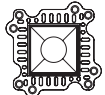
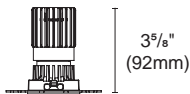

2" (51mm)
4" (101mm)

Cut out : 2 1/2" X 2 1/2" (60X60mm)

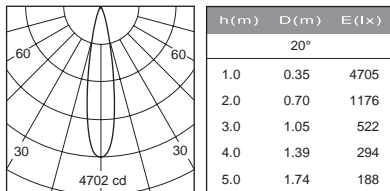

EPIC-65-STLA

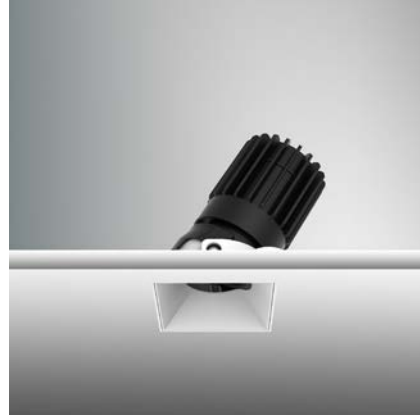

Article number	2118.241A-LEA-13
Fixture Consumption	12W
Current	250 (mA)
Delivered Lumen	755 (lm)
HE Delivered Lumen*	890 (lm)
Beam Angle	20°/40°/55° (Lens)
CCT	3000K
CRI	90+
Driver Model	PUP10A-1WMC-350

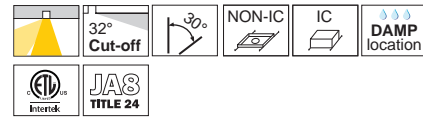

Dimmable

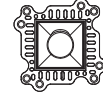
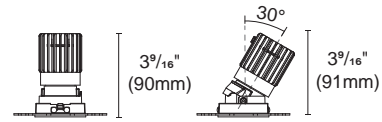

2" (51mm)
4" (101mm)

Cut out : 2 1/2" X 2 1/2" (60X60mm)

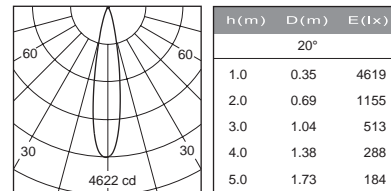

Accessories



ACSG-5 Striped PC sheet ACHO-6 Honeycomb louver ACDS-3 Diffusion sheet ACWG-6 Woven glass ACOT-107 Suction cup





EPIC-85

2.8"

Round / Square

Fixed
Adjustable
Wallwash

EPIC-85-RTF



EPIC-85-RTA



EPIC-85-RTW



Article number	2118.125-LEA-14	
	NON-IC	IC
Fixture Consumption	20W	18 W
Current	450 (mA)	400 (mA)
Delivered Lumen	1362 (lm)	1231 (lm)
HE Delivered Lumen*	1702 (lm)	1538 (lm)
Beam Angle	25°/35°/45°/55° (Lens)	
CCT	3000K	
CRI	90+	
Driver Model	PUP20A-1WMC	
Article number	2118.125-LEA-14-DW	
Fixture Consumption	15W	
Current	350 (mA)	
Delivered Lumen	836 (lm)	
Beam Angle	25°/30°/36°/50° (Lens)	
CCT	1800-3000K	
CRI	90+	
Driver Model	PUP20A-1WMC	

Article number	2118.126-LEA-14	
	NON-IC	IC
Fixture Consumption	20W	18 W
Current	450 (mA)	400 (mA)
Delivered Lumen	1350 (lm)	1196 (lm)
HE Delivered Lumen*	1687 (lm)	1495 (lm)
Beam Angle	25°/35°/45°/55° (Lens)	
CCT	3000K	
CRI	90+	
Driver Model	PUP20A-1WMC	
Article number	2118.126-LEA-14-DW	
Fixture Consumption	15W	
Current	350 (mA)	
Delivered Lumen	809 (lm)	
Beam Angle	25°/30°/36°/50° (Lens)	
CCT	1800-3000K	
CRI	90+	
Driver Model	PUP20A-1WMC	

Article number	2118.127-LEA-14	
	NON-IC	IC
Fixture Consumption	20W	18 W
Current	450 (mA)	400 (mA)
Delivered Lumen	853 (lm)	850 (lm)
HE Delivered Lumen*	1066 (lm)	1062 (lm)
Beam Angle	Wallwash (Lens)	
CCT	3000K	
CRI	90+	
Driver Model	PUP20A-1WMC	
Article number	2118.127-LEA-14-DW	
Fixture Consumption	15W	
Current	350 (mA)	
Delivered Lumen	618 (lm)	
Beam Angle	Wallwash (Lens)	
CCT	1800-3000K	
CRI	90+	
Driver Model	PUP20A-1WMC	

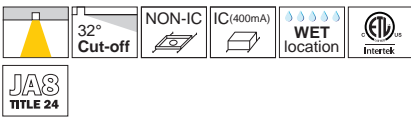

Dimmable

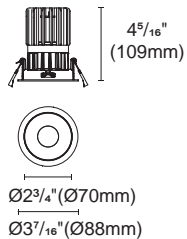

Cut out : 3 5/32" (80mm)

Accessories

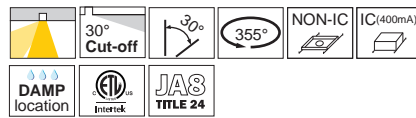

Dimmable

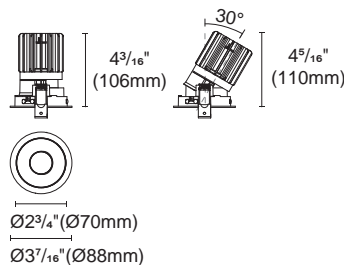

Cut out : 3 5/32" (80mm)

Accessories



Dimmable

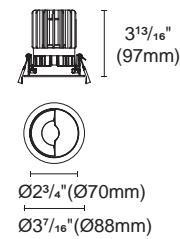

Cut out : 3 5/32" (80mm)

Accessories



← Accessories are not suitable for wallwash fixtures



EPIC-85-RTLF

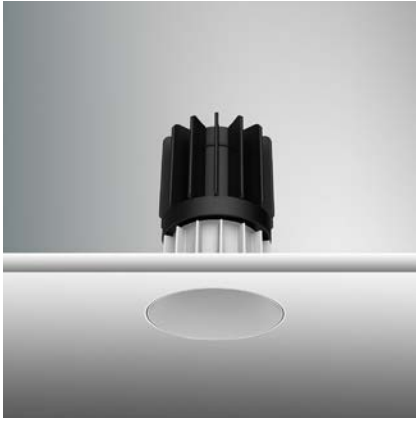

Article number	2118.225F-LEA-14	
	NON-IC	IC
Fixture Consumption	20W	18 W
Current	450 (mA)	400 (mA)
Delivered Lumen	1362 (lm)	1231 (lm)
HE Delivered Lumen*	1702 (lm)	1538 (lm)
Beam Angle	25°/35°/45°/55° (Lens)	
CCT	3000K	
CRI	90+	
Driver Model	PUP20A-1WMC	
Article number	2118.225F-LEA-14-DW	
	NON-IC	IC
Fixture Consumption	15W	
Current	350 (mA)	
Delivered Lumen	836 (lm)	
Beam Angle	25°/30°/36°/50° (Lens)	
CCT	1800-3000K	
CRI	90+	
Driver Model	PUP20A-1WMC	

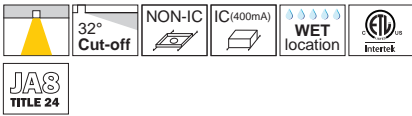

Dimmable

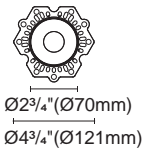
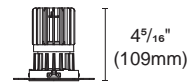

⊖ Cut out : 3 5/32" (80mm)

Accessories



EPIC-85-RTLA



Article number	2118.226F-LEA-14	
	NON-IC	IC
Fixture Consumption	20W	18 W
Current	450 (mA)	400 (mA)
Delivered Lumen	1350 (lm)	1196 (lm)
HE Delivered Lumen*	1687 (lm)	1495 (lm)
Beam Angle	25°/35°/45°/55° (Lens)	
CCT	3000K	
CRI	90+	
Driver Model	PUP20A-1WMC	
Article number	2118.226F-LEA-14-DW	
	NON-IC	IC
Fixture Consumption	15W	
Current	350 (mA)	
Delivered Lumen	809 (lm)	
Beam Angle	25°/30°/36°/50° (Lens)	
CCT	1800-3000K	
CRI	90+	
Driver Model	PUP20A-1WMC	

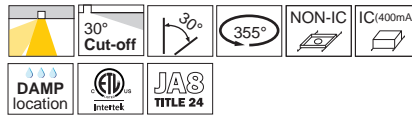

Dimmable

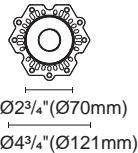
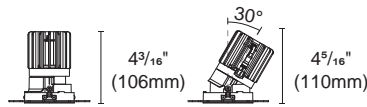

⊖ Cut out : 3 5/32" (80mm)

EPIC-85-RTLW

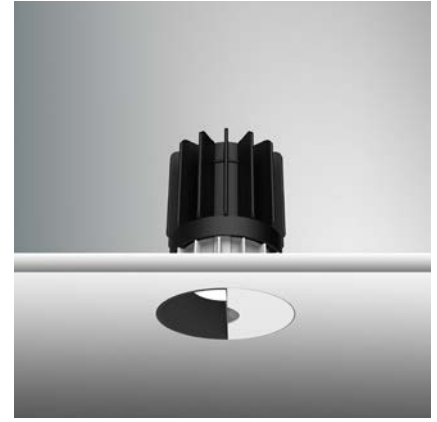

Article number	2118.227F-LEA-14	
	NON-IC	IC
Fixture Consumption	20W	18 W
Current	450 (mA)	400 (mA)
Delivered Lumen	853 (lm)	850 (lm)
HE Delivered Lumen*	1066 (lm)	1062 (lm)
Beam Angle	Wallwash (Lens)	
CCT	3000K	
CRI	90+	
Driver Model	PUP20A-1WMC	
Article number	2118.227F-LEA-14-DW	
	NON-IC	IC
Fixture Consumption	15W	
Current	350 (mA)	
Delivered Lumen	618 (lm)	
Beam Angle	Wallwash (Lens)	
CCT	1800-3000K	
CRI	90+	
Driver Model	PUP20A-1WMC	

*Wallwash lens — best optical matching angle: 15°

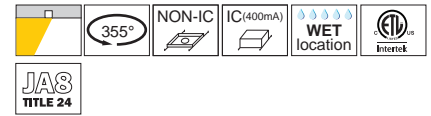

Dimmable

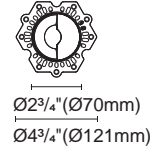

⊖ Cut out : 3 5/32" (80mm)

← Accessories are not suitable for wallwash fixtures



ACSG-4 Striped glass

ACHO-5 Honeycomb louver

ACDS-4 Diffusion sheet

ACWG-5 Woven glass

ACOT-108 Suction cup

EP85-TL-WD Millwork

EPIC-85-STF



EPIC-85-STA



EPIC-85-STW



Article number	2118.128-LEA-14	
	NON-IC	IC
Fixture Consumption	20W	18 W
Current	450 (mA)	400 (mA)
Delivered Lumen	1374 (lm)	1235 (lm)
HE Delivered Lumen*	1717 (lm)	1543 (lm)
Beam Angle	25°/35°/45°/55° (Lens)	
CCT	3000K	
CRI	90+	
Driver Model	PUP20A-1WMC	
Article number	2118.128-LEA-14-DW	
Fixture Consumption	15W	
Current	350 (mA)	
Delivered Lumen	835 (lm)	
Beam Angle	25°/30°/36°/50° (Lens)	
CCT	1800-3000K	
CRI	90+	
Driver Model	PUP20A-1WMC	

Article number	2118.129-LEA-14	
	NON-IC	IC
Fixture Consumption	20W	18 W
Current	450 (mA)	400 (mA)
Delivered Lumen	1357 (lm)	1216 (lm)
HE Delivered Lumen*	1696 (lm)	1520 (lm)
Beam Angle	25°/35°/45°/55° (Lens)	
CCT	3000K	
CRI	90+	
Driver Model	PUP20A-1WMC	
Article number	2118.129-LEA-14-DW	
Fixture Consumption	15W	
Current	350 (mA)	
Delivered Lumen	834 (lm)	
Beam Angle	25°/30°/36°/50° (Lens)	
CCT	1800-3000K	
CRI	90+	
Driver Model	PUP20A-1WMC	

Article number	2118.130-LEA-14	
	NON-IC	IC
Fixture Consumption	20W	18 W
Current	450 (mA)	400 (mA)
Delivered Lumen	867 (lm)	839 (lm)
HE Delivered Lumen*	1083 (lm)	1048 (lm)
Beam Angle	Wallwash (Lens)	
CCT	3000K	
CRI	90+	
Driver Model	PUP20A-1WMC	
Article number	2118.130-LEA-14-DW	
Fixture Consumption	15W	
Current	350 (mA)	
Delivered Lumen	634 (lm)	
Beam Angle	Wallwash (Lens)	
CCT	1800-3000K	
CRI	90+	
Driver Model	PUP20A-1WMC	

*Wallwash lens — best optical matching angle: 15°

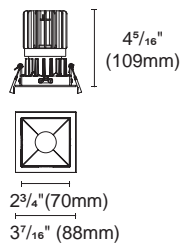
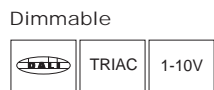
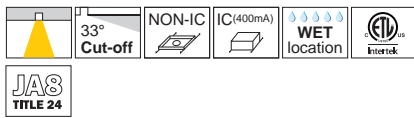

Cut out : 3⁵/₃₂"X3⁵/₃₂" (80X80mm)

Accessories

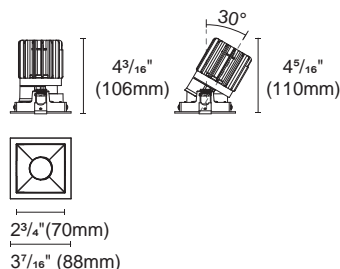
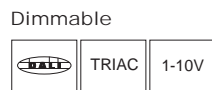
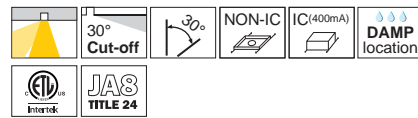

Cut out : 3⁵/₃₂"X3⁵/₃₂" (80X80mm)

Accessories

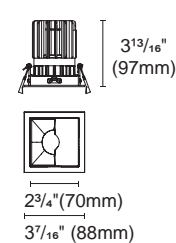

Cut out : 3⁵/₃₂"X3⁵/₃₂" (80X80mm)

Accessories are not suitable for wallwash fixtures



EPIC-85-STLF



Article number	2118.228A-LEA-14	
	NON-IC	IC
Fixture Consumption	20W	18 W
Current	450 (mA)	400 (mA)
Delivered Lumen	1374 (lm)	1235 (lm)
HE Delivered Lumen*	1717 (lm)	1543 (lm)
Beam Angle	25°/35°/45°/55° (Lens)	
CCT	3000K	
CRI	90+	
Driver Model	PUP20A-1WMC	
Article number	2118.228A-LEA-14-DW	
	NON-IC	IC
Fixture Consumption	15W	
Current	350 (mA)	
Delivered Lumen	835 (lm)	
Beam Angle	25°/30°/36°/50° (Lens)	
CCT	1800-3000K	
CRI	90+	
Driver Model	PUP20A-1WMC	

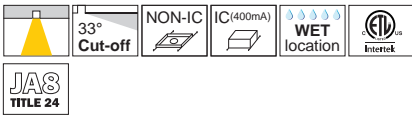

Dimmable

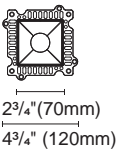
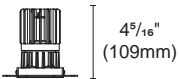

Cut out : 3 5/32"X3 5/32" (80X80mm)

Accessories



EPIC-85-STLA



Article number	2118.229A-LEA-14	
	NON-IC	IC
Fixture Consumption	20W	18 W
Current	450 (mA)	400 (mA)
Delivered Lumen	1357 (lm)	1216 (lm)
HE Delivered Lumen*	1696 (lm)	1520 (lm)
Beam Angle	25°/35°/45°/55° (Lens)	
CCT	3000K	
CRI	90+	
Driver Model	PUP20A-1WMC	
Article number	2118.229A-LEA-14-DW	
	NON-IC	IC
Fixture Consumption	15W	
Current	350 (mA)	
Delivered Lumen	834 (lm)	
Beam Angle	25°/30°/36°/50° (Lens)	
CCT	1800-3000K	
CRI	90+	
Driver Model	PUP20A-1WMC	

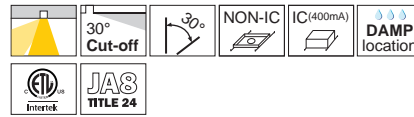

Dimmable

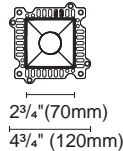
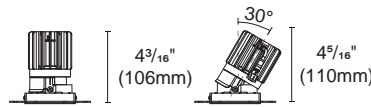

Cut out : 3 5/32"X3 5/32" (80X80mm)

EPIC-85-STLW

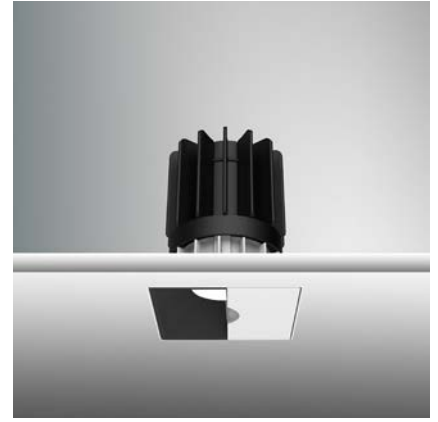

Article number	2118.230A-LEA-14	
	NON-IC	IC
Fixture Consumption	20W	18 W
Current	450 (mA)	400 (mA)
Delivered Lumen	867 (lm)	839 (lm)
HE Delivered Lumen*	1083 (lm)	1048 (lm)
Beam Angle	Wallwash (Lens)	
CCT	3000K	
CRI	90+	
Driver Model	PUP20A-1WMC	
Article number	2118.230A-LEA-14-DW	
	NON-IC	IC
Fixture Consumption	15W	
Current	350 (mA)	
Delivered Lumen	634 (lm)	
Beam Angle	Wallwash (Lens)	
CCT	1800-3000K	
CRI	90+	
Driver Model	PUP20A-1WMC	



Dimmable

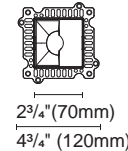
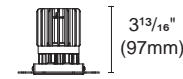

Cut out : 3 5/32"X3 5/32" (80X80mm)

← Accessories are not suitable for wallwash fixtures







EPIC-110 ▶

3.5"

Round / Square

Fixed
Adjustable
Wallwash

EPIC-110-RTF1

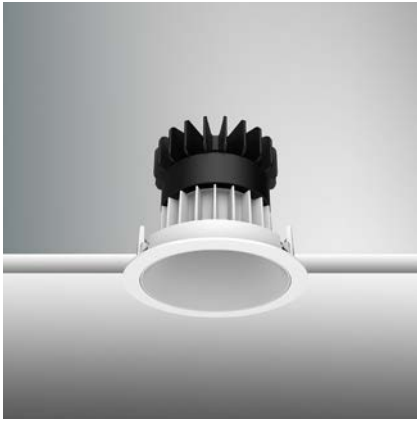

Article number	2018.481-LEA-15
Fixture Consumption	21W
Current	500 (mA)
Delivered Lumen	1697 (lm)
HE Delivered Lumen*	2121 (lm)
Beam Angle	20°/30°/45°/55°/65° (Lens)
CCT	3000K
CRI	90+
Driver Model	PUP20A-1WMC

Article number	2018.481-LEA-15-DW
Fixture Consumption	18W
Current	450 (mA)
Delivered Lumen	1200 (lm)
Beam Angle	20°/25°/40°/50° (Lens)
CCT	1800-3000K
CRI	90+
Driver Model	PUP20A-1WMC



Dimmable

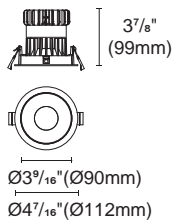

⊘ Cut out : 3³⁰/₃₂" (100mm)

EPIC-110-RTA1



Article number	2018.494-LEA-15
Fixture Consumption	21W
Current	500 (mA)
Delivered Lumen	1702 (lm)
HE Delivered Lumen*	2127 (lm)
Beam Angle	20°/30°/45°/55°/65° (Lens)
CCT	3000K
CRI	90+
Driver Model	PUP20A-1WMC

Article number	2018.494-LEA-15-DW
Fixture Consumption	18W
Current	450 (mA)
Delivered Lumen	1190 (lm)
Beam Angle	20°/25°/40°/50° (Lens)
CCT	1800-3000K
CRI	90+
Driver Model	PUP20A-1WMC

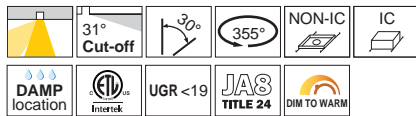

Dimmable

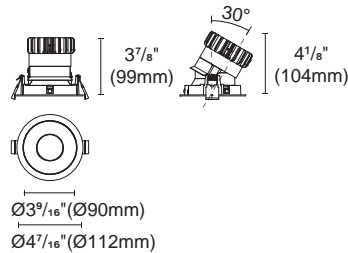

⊘ Cut out : 3³⁰/₃₂" (100mm)

EPIC-110-RTW1

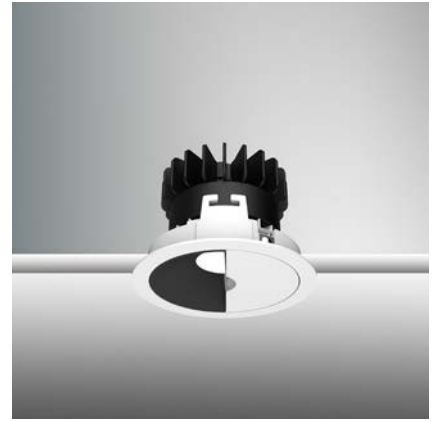

Article number	2018.482-LEA-15
Fixture Consumption	21W
Current	500 (mA)
Delivered Lumen	1100 (lm)
HE Delivered Lumen*	1375 (lm)
Beam Angle	Wallwash (Lens)
CCT	3000K
CRI	90+
Driver Model	PUP20A-1WMC

Article number	2018.482-LEA-15-DW
Fixture Consumption	18W
Current	450 (mA)
Delivered Lumen	713 (lm)
Beam Angle	Wallwash (Lens)
CCT	1800-3000K
CRI	90+
Driver Model	PUP20A-1WMC

*Wallwash lens — best optical matching angle: 36°

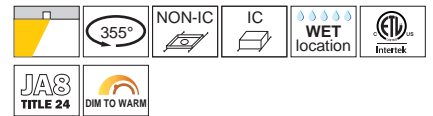

Dimmable

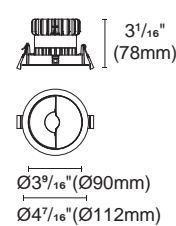

⊘ Cut out : 3³⁰/₃₂" (100mm)

Accessories



SG7-1
Striped glass

H7-1
Honeycomb louver

DS7-1
Diffusion sheet

WG7-1
Woven glass

ACOT-109
Suction cup

← Accessories are not suitable for wallwash fixtures



EP110-GOOFRING-4
Goof ring for 4"

EP110-GOOFRING-6
Goof ring for 6"

EPIC-110-RTLF1

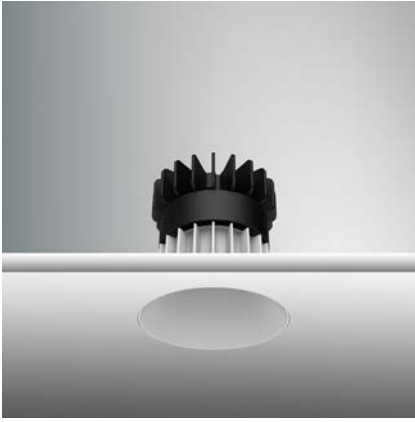

Article number	2018.275F-LEA-15
Fixture Consumption	21W
Current	500 (mA)
Delivered Lumen	1697 (lm)
HE Delivered Lumen*	2121 (lm)
Beam Angle	20°/30°/45°/55°/65° (Lens)
CCT	3000K
CRI	90+
Driver Model	PUP20A-1WMC

Article number	2018.275F-LEA-15-DW
Fixture Consumption	18W
Current	450 (mA)
Delivered Lumen	1200 (lm)
Beam Angle	20°/25°/40°/50° (Lens)
CCT	1800-3000K
CRI	90+
Driver Model	PUP20A-1WMC

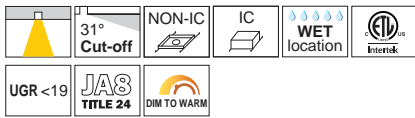

Dimmable

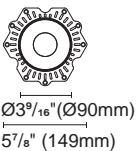

⊖ Cut out : 3³⁰/₃₂" (100mm)

EPIC-110-RTLA1

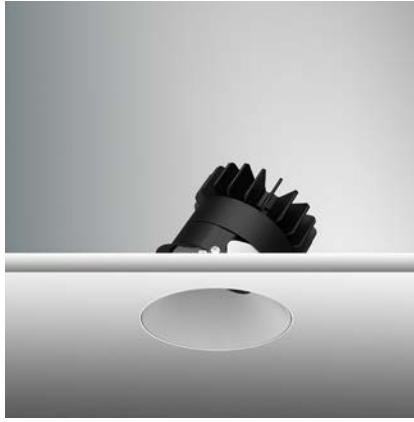

Article number	2018.294F-LEA-15
Fixture Consumption	21W
Current	500 (mA)
Delivered Lumen	1702 (lm)
HE Delivered Lumen*	2127 (lm)
Beam Angle	20°/30°/45°/55°/65° (Lens)
CCT	3000K
CRI	90+
Driver Model	PUP20A-1WMC

Article number	2018.294F-LEA-15-DW
Fixture Consumption	18W
Current	450 (mA)
Delivered Lumen	1190 (lm)
Beam Angle	20°/25°/40°/50° (Lens)
CCT	1800-3000K
CRI	90+
Driver Model	PUP20A-1WMC

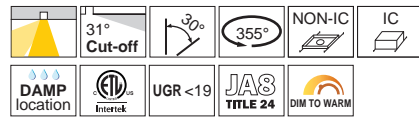

Dimmable

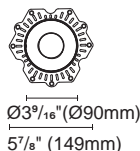
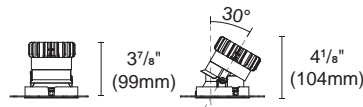

⊖ Cut out : 3³⁰/₃₂" (100mm)

EPIC-110-RTLW1

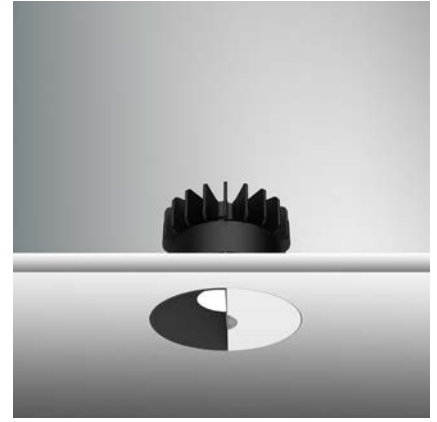

Article number	2018.276F-LEA-15
Fixture Consumption	21W
Current	500 (mA)
Delivered Lumen	1100 (lm)
HE Delivered Lumen*	1375 (lm)
Beam Angle	Wallwash (Lens)
CCT	3000K
CRI	90+
Driver Model	PUP20A-1WMC

Article number	2018.276F-LEA-15-DW
Fixture Consumption	18W
Current	450 (mA)
Delivered Lumen	713 (lm)
Beam Angle	Wallwash (Lens)
CCT	1800-3000K
CRI	90+
Driver Model	PUP20A-1WMC

*Wallwash lens — best optical matching angle: 36°

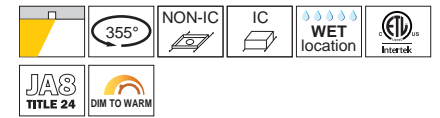

Dimmable

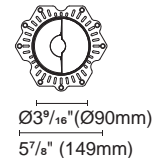

⊖ Cut out : 3³⁰/₃₂" (100mm)

Accessories



SG7-1 Striped glass | H7-1 Honeycomb louver | DS7-1 Diffusion sheet | WG7-1 Woven glass | ACOT-109 Suction cup

← Accessories are not suitable for wallwash fixtures



EP110-TL-WD Millwork

EPIC-110-STF1



EPIC-110-STA1



EPIC-110-STW1

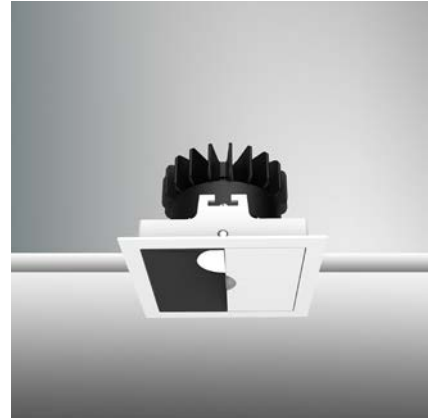

Article number	2018.483-LEA-15
Fixture Consumption	21W
Current	500 (mA)
Delivered Lumen	1639 (lm)
HE Delivered Lumen*	2048 (lm)
Beam Angle	20°/30°/45°/55°/65° (Lens)
CCT	3000K
CRI	90+
Driver Model	PUP20A-1WMC

Article number	2018.495-LEA-15
Fixture Consumption	21W
Current	500 (mA)
Delivered Lumen	1616 (lm)
HE Delivered Lumen*	2020 (lm)
Beam Angle	20°/30°/45°/55°/65° (Lens)
CCT	3000K
CRI	90+
Driver Model	PUP20A-1WMC

Article number	2018.484-LEA-15
Fixture Consumption	21W
Current	500 (mA)
Delivered Lumen	1062 (lm)
HE Delivered Lumen*	1327 (lm)
Beam Angle	Wallwash (Lens)
CCT	3000K
CRI	90+
Driver Model	PUP20A-1WMC

Article number	2018.483-LEA-15-DW
Fixture Consumption	18W
Current	450 (mA)
Delivered Lumen	1212 (lm)
Beam Angle	20°/25°/40°/50° (Lens)
CCT	1800-3000K
CRI	90+
Driver Model	PUP20A-1WMC

Article number	2018.495-LEA-15-DW
Fixture Consumption	18W
Current	450 (mA)
Delivered Lumen	1227 (lm)
Beam Angle	20°/25°/40°/50° (Lens)
CCT	1800-3000K
CRI	90+
Driver Model	PUP20A-1WMC

Article number	2018.484-LEA-15-DW
Fixture Consumption	18W
Current	450 (mA)
Delivered Lumen	740 (lm)
Beam Angle	Wallwash (Lens)
CCT	1800-3000K
CRI	90+
Driver Model	PUP20A-1WMC



Dimmable

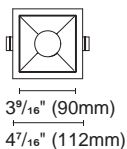

□ Cut out : 3³⁰/₃₂"X3³⁰/₃₂" (100X100mm)

Accessories



SG7-1 Striped glass, H7-1 Honeycomb louver, DS7-1 Diffusion sheet, WG7-1 Woven glass, ACOT-109 Suction cup



Dimmable

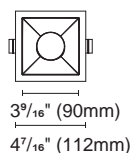
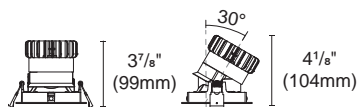

□ Cut out : 3³⁰/₃₂"X3³⁰/₃₂" (100X100mm)

Accessories

*Wallwash lens — best optical matching angle: 36°

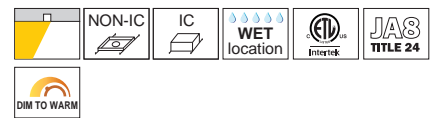

Dimmable

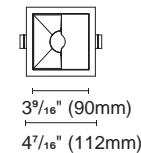

□ Cut out : 3³⁰/₃₂"X3³⁰/₃₂" (100X100mm)

Accessories are not suitable for wallwash fixtures

EPIC-110-STLF1

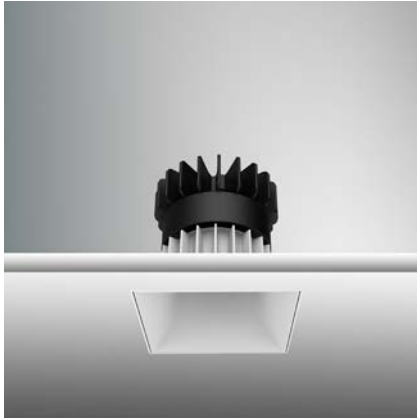

Article number	2018.277A-LEA-15
Fixture Consumption	21W
Current	500 (mA)
Delivered Lumen	1639 (lm)
HE Delivered Lumen*	2048 (lm)
Beam Angle	20°/30°/45°/55°/65° (Lens)
CCT	3000K
CRI	90+
Driver Model	PUP20A-1WMC

Article number	2018.277A-LEA-15-DW
Fixture Consumption	18W
Current	450 (mA)
Delivered Lumen	1212 (lm)
Beam Angle	20°/25°/40°/50° (Lens)
CCT	1800-3000K
CRI	90+
Driver Model	PUP20A-1WMC



Dimmable

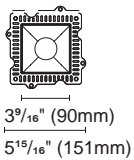

Cut out : 3³⁰/₃₂"X3³⁰/₃₂" (100X100mm)

EPIC-110-STLA1



Article number	2018.295A-LEA-15
Fixture Consumption	21W
Current	500 (mA)
Delivered Lumen	1616 (lm)
HE Delivered Lumen*	2020 (lm)
Beam Angle	20°/30°/45°/55°/65° (Lens)
CCT	3000K
CRI	90+
Driver Model	PUP20A-1WMC

Article number	2018.295A-LEA-15-DW
Fixture Consumption	18W
Current	450 (mA)
Delivered Lumen	1227 (lm)
Beam Angle	20°/25°/40°/50° (Lens)
CCT	1800-3000K
CRI	90+
Driver Model	PUP20A-1WMC



Dimmable

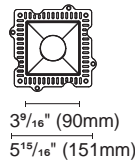
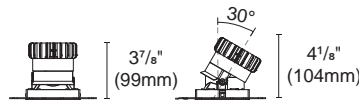

Cut out : 3³⁰/₃₂"X3³⁰/₃₂" (100X100mm)

EPIC-110-STLW1

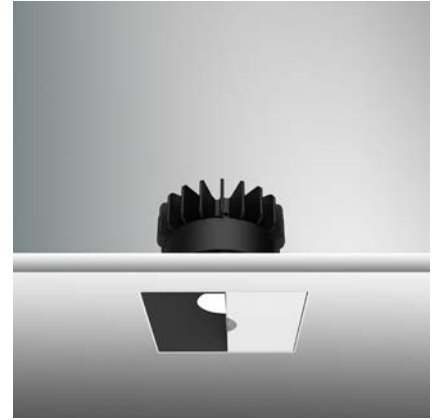

Article number	2018.278A-LEA-15
Fixture Consumption	21W
Current	500 (mA)
Delivered Lumen	1062 (lm)
HE Delivered Lumen*	1327 (lm)
Beam Angle	Wallwash (Lens)
CCT	3000K
CRI	90+
Driver Model	PUP20A-1WMC

Article number	2018.278A-LEA-15-DW
Fixture Consumption	18W
Current	450 (mA)
Delivered Lumen	740 (lm)
Beam Angle	Wallwash (Lens)
CCT	1800-3000K
CRI	90+
Driver Model	PUP20A-1WMC

*Wallwash lens — best optical matching angle: 36°

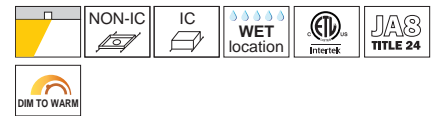

Dimmable

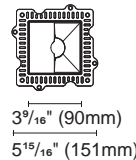

Cut out : 3³⁰/₃₂"X3³⁰/₃₂" (100X100mm)

Accessories



← Accessories are not suitable for wallwash fixtures



SG7-1 Striped glass

H7-1 Honeycomb louver

DS7-1 Diffusion sheet

WG7-1 Woven glass

ACOT-109 Suction cup

EP110-TL-WD Millwork

EPIC-110-RTF



Article number	2018.481-ACOT-84-AM	
	NON-IC	IC
Fixture Consumption	30W	25W
Current	700 (mA)	600 (mA)
Delivered Lumen	2263 (lm)	1846 (lm)
HE Delivered Lumen*	2851 (lm)	2307 (lm)
Beam Angle	30°/40°/50°/60° (Lens)	
CCT	3000K	
CRI	90+	
Driver Model	PUP40A-1WMC-850	

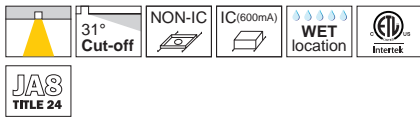

Dimmable

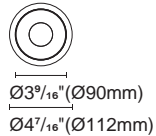
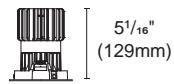

⌀ Cut out : 3³⁰/₃₂" (100mm)

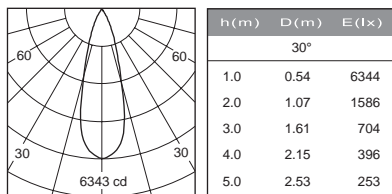

EPIC-110-RTA



Article number	2018.494-ACOT-84-AM	
	NON-IC	IC
Fixture Consumption	30W	25W
Current	700 (mA)	600 (mA)
Delivered Lumen	2235 (lm)	1871 (lm)
HE Delivered Lumen*	2816 (lm)	2338 (lm)
Beam Angle	30°/40°/50°/60° (Lens)	
CCT	3000K	
CRI	90+	
Driver Model	PUP40A-1WMC-850	

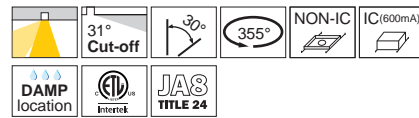

Dimmable

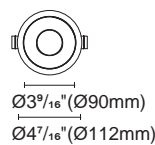
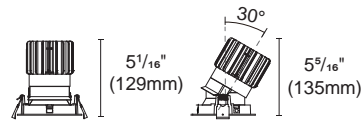

⌀ Cut out : 3³⁰/₃₂" (100mm)

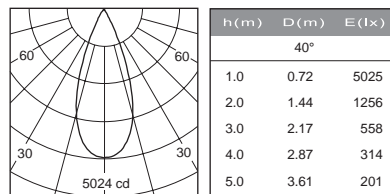

EPIC-110-RTW



Article number	2018.482-ACOT-84-AM	
	NON-IC	IC
Fixture Consumption	30W	25W
Current	700 (mA)	600 (mA)
Delivered Lumen	1497 (lm)	1184 (lm)
HE Delivered Lumen*	1886 (lm)	1480 (lm)
Beam Angle	Wallwash (Lens)	
CCT	3000K	
CRI	90+	
Driver Model	PUP40A-1WMC-850	

*Wallwash lens — best optical matching angle: 36°

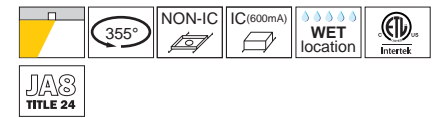

Dimmable

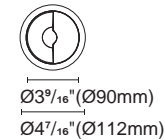
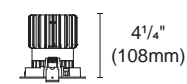

⌀ Cut out : 3³⁰/₃₂" (100mm)

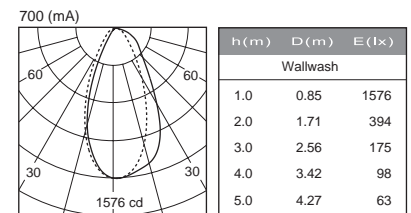

Accessories



← Accessories are not suitable for wallwash fixtures

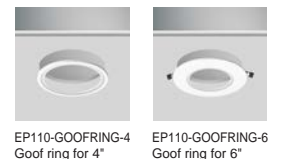

EPIC-110-RTLF

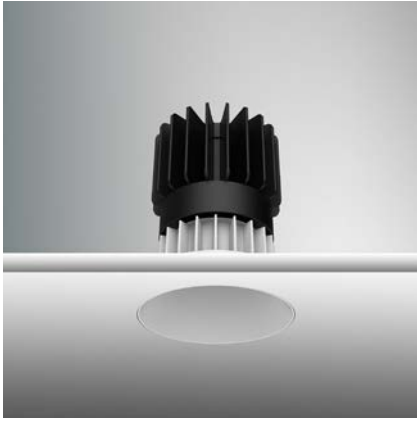

Article number	2018.275F-ACOT-84-AM	
	NON-IC	IC
Fixture Consumption	30W	25W
Current	700 (mA)	600 (mA)
Delivered Lumen	2263 (lm)	1846 (lm)
HE Delivered Lumen*	2851 (lm)	2307 (lm)
Beam Angle	30°/40°/50°/60° (Lens)	
CCT	3000K	
CRI	90+	
Driver Model	PUP40A-1WMC-850	

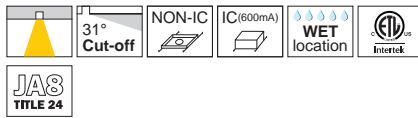

Dimmable

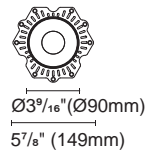
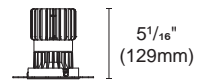

⌀ Cut out : 3^{30/32}" (100mm)

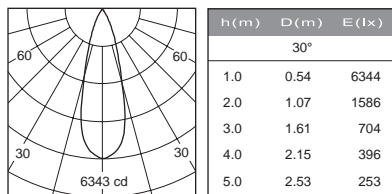

EPIC-110-RTLA



Article number	2018.294F-ACOT-84-AM	
	NON-IC	IC
Fixture Consumption	30W	25W
Current	700 (mA)	600 (mA)
Delivered Lumen	2235 (lm)	1871 (lm)
HE Delivered Lumen*	2816 (lm)	2338 (lm)
Beam Angle	30°/40°/50°/60° (Lens)	
CCT	3000K	
CRI	90+	
Driver Model	PUP40A-1WMC-850	

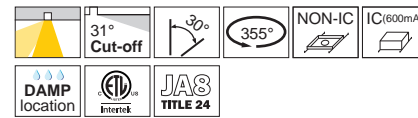

Dimmable

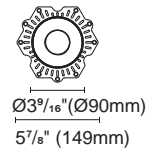
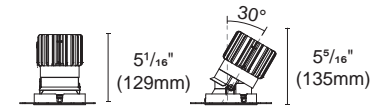

⌀ Cut out : 3^{30/32}" (100mm)

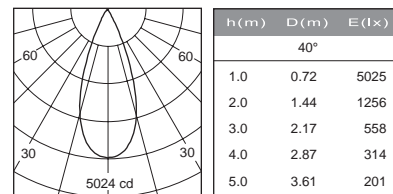

EPIC-110-RTLW

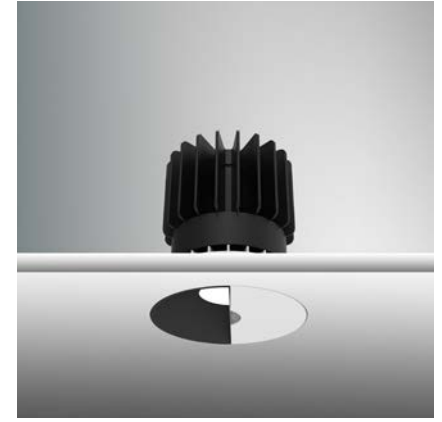

Article number	2018.276F-ACOT-84-AM	
	NON-IC	IC
Fixture Consumption	30W	25W
Current	700 (mA)	600 (mA)
Delivered Lumen	1497 (lm)	1184 (lm)
HE Delivered Lumen*	1886 (lm)	1480 (lm)
Beam Angle	Wallwash (Lens)	
CCT	3000K	
CRI	90+	
Driver Model	PUP40A-1WMC-850	

*Wallwash lens — best optical matching angle: 36°

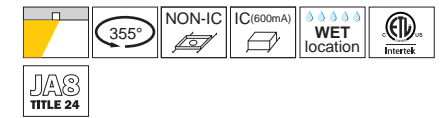

Dimmable

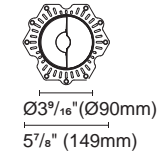
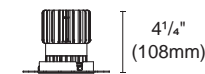

⌀ Cut out : 3^{30/32}" (100mm)

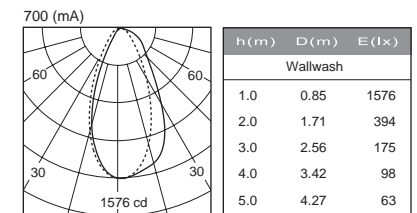

Accessories



← Accessories are not suitable for wallwash fixtures



EPIC-110-STF



Article number	2018.483-ACOT-84-AM	
	NON-IC	IC
Fixture Consumption	30W	25W
Current	700 (mA)	600 (mA)
Delivered Lumen	2307 (lm)	1852 (lm)
HE Delivered Lumen*	2906 (lm)	2315 (lm)
Beam Angle	30°/40°/50°/60° (Lens)	
CCT	3000K	
CRI	90+	
Driver Model	PUP40A-1WMC-850	

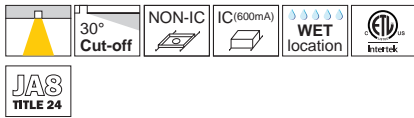

Dimmable

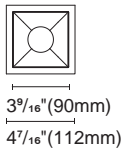
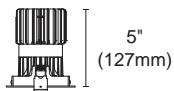

Cut out : 3^{30/32}"X3^{30/32}" (100X100mm)

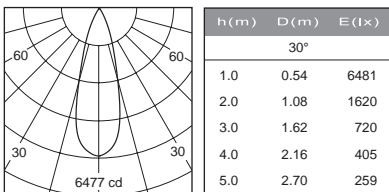

EPIC-110-STA



Article number	2018.495-ACOT-84-AM	
	NON-IC	IC
Fixture Consumption	30W	25W
Current	700 (mA)	600 (mA)
Delivered Lumen	2250 (lm)	1877 (lm)
HE Delivered Lumen*	2835 (lm)	2346 (lm)
Beam Angle	30°/40°/50°/60° (Lens)	
CCT	3000K	
CRI	90+	
Driver Model	PUP40A-1WMC-850	

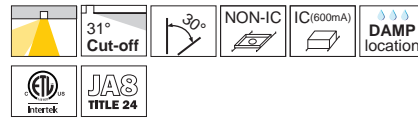

Dimmable

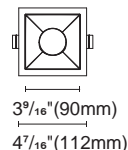
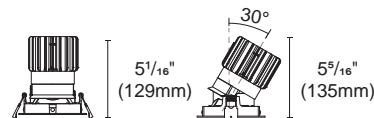

Cut out : 3^{30/32}"X3^{30/32}" (100X100mm)

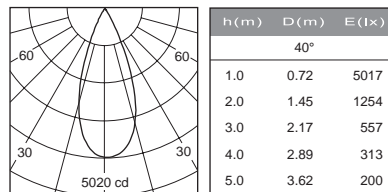

EPIC-110-STW



Article number	2018.484-ACOT-84-AM	
	NON-IC	IC
Fixture Consumption	30W	25W
Current	700 (mA)	600 (mA)
Delivered Lumen	1500 (lm)	1172 (lm)
HE Delivered Lumen*	1890 (lm)	1465 (lm)
Beam Angle	Wallwash (Lens)	
CCT	3000K	
CRI	90+	
Driver Model	PUP40A-1WMC-850	

*Wallwash lens — best optical matching angle: 36°



Dimmable

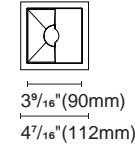
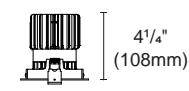

Cut out : 3^{30/32}"X3^{30/32}" (100X100mm)

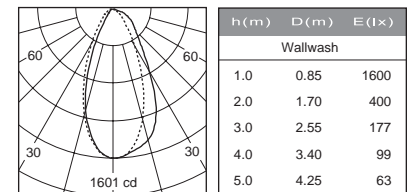

Accessories



Accessories are not suitable for wallwash fixtures

EPIC-110-STLF

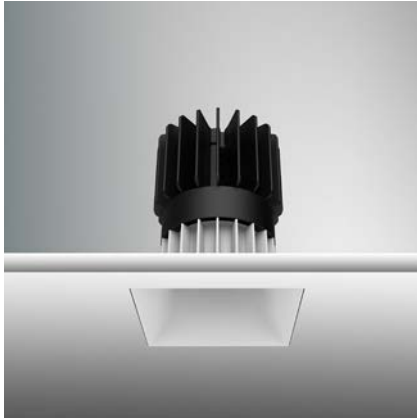

Article number	2018.277A-ACOT-84-AM	
	NON-IC	IC
Fixture Consumption	30W	25W
Current	700 (mA)	600 (mA)
Delivered Lumen	2307 (lm)	1852 (lm)
HE Delivered Lumen*	2906 (lm)	2315 (lm)
Beam Angle	30°/40°/50°/60° (Lens)	
CCT	3000K	
CRI	90+	
Driver Model	PUP40A-1WMC-850	

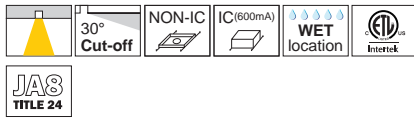

Dimmable

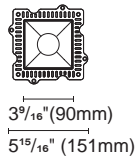
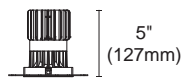

Cut out : 3^{30/32}"X3^{30/32}" (100X100mm)

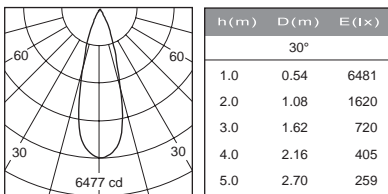

EPIC-110-STLA



Article number	2018.295A-ACOT-84-AM	
	NON-IC	IC
Fixture Consumption	30W	25W
Current	700 (mA)	600 (mA)
Delivered Lumen	2250 (lm)	1877 (lm)
HE Delivered Lumen*	2835 (lm)	2346 (lm)
Beam Angle	30°/40°/50°/60° (Lens)	
CCT	3000K	
CRI	90+	
Driver Model	PUP40A-1WMC-850	

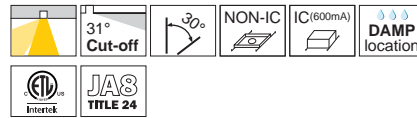

Dimmable

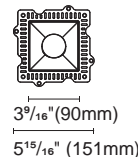
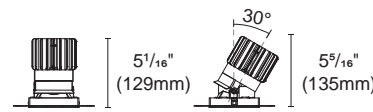

Cut out : 3^{30/32}"X3^{30/32}" (100X100mm)

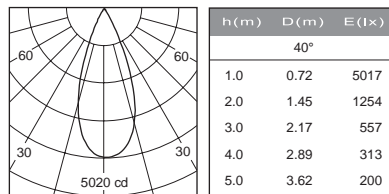

EPIC-110-STLW

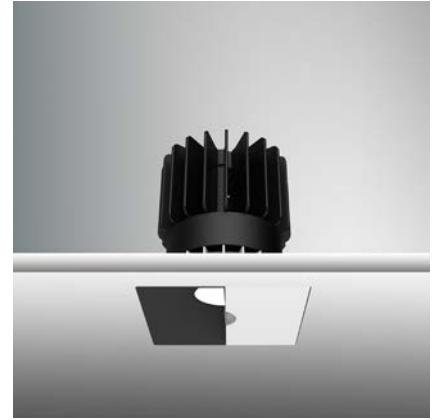

Article number	2018.278A-ACOT-84-AM	
	NON-IC	IC
Fixture Consumption	30W	25W
Current	700 (mA)	600 (mA)
Delivered Lumen	1500 (lm)	1172 (lm)
HE Delivered Lumen*	1890 (lm)	1465 (lm)
Beam Angle	Wallwash (Lens)	
CCT	3000K	
CRI	90+	
Driver Model	PUP40A-1WMC-850	

*Wallwash lens — best optical matching angle: 36°



Dimmable

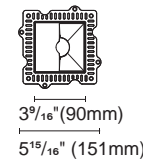

Cut out : 3^{30/32}"X3^{30/32}" (100X100mm)

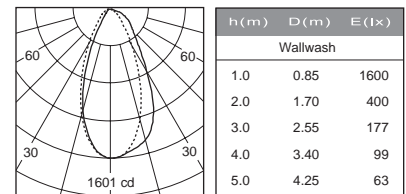

Accessories



← Accessories are not suitable for wallwash fixtures



SG7-1 Striped glass

H7-1 Honeycomb louver

DS7-1 Diffusion sheet

WG7-1 Woven glass

ACOT-109 Suction cup

EP110-TL-WD Millwork

2018.481-LEA-15
2018.275F-LEA-15

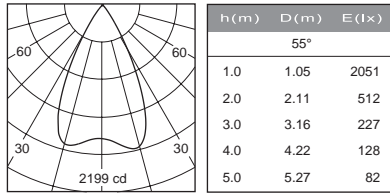
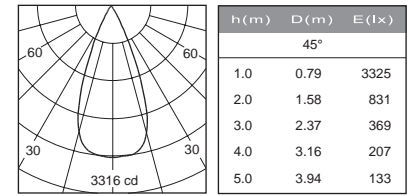
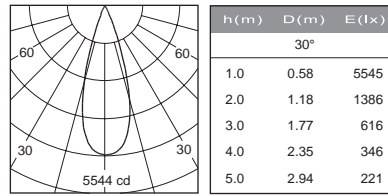
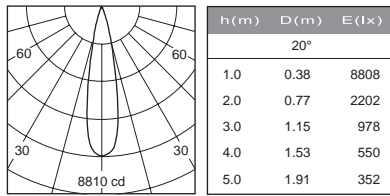

2018.481-LEA15DW
2018.275F-LEA15DW

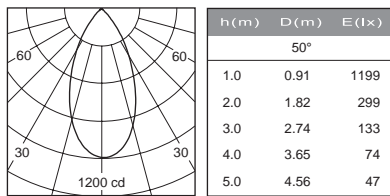
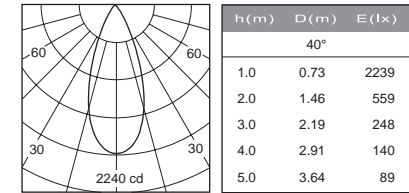
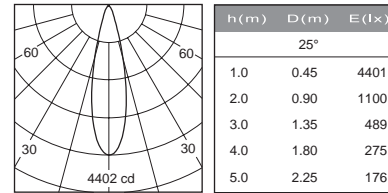
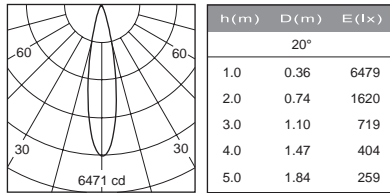

2018.494-LEA-15
2018.294F-LEA-15

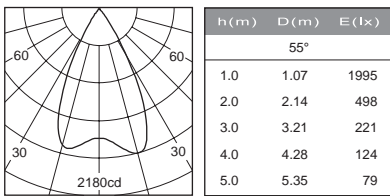
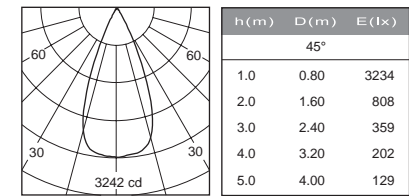
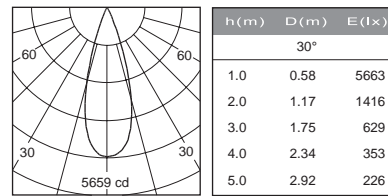
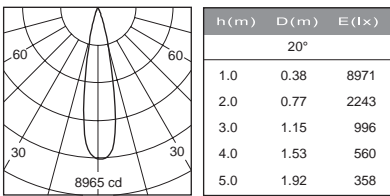

2018.494-LEA15DW
2018.294F-LEA15DW

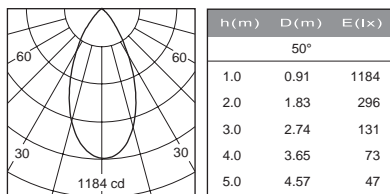
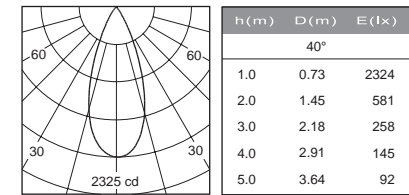
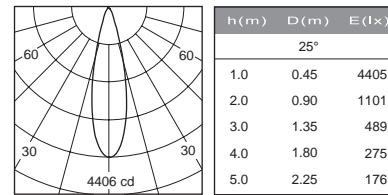
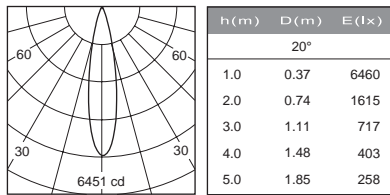

2018.482-LEA-15
2018.276F-LEA-15

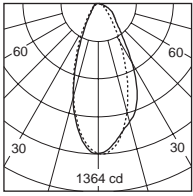

h (m)	D (m)	E (lx)
Wallwash		
1.0	0.77	1360
2.0	1.54	340
3.0	2.32	151
4.0	3.09	85
5.0	3.86	54

2018.482-LEA15DW
2018.276F-LEA15DW

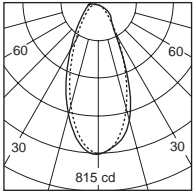

h (m)	D (m)	E (lx)
Wallwash		
1.0	0.80	811
2.0	1.60	202
3.0	2.40	90
4.0	3.21	50
5.0	4.01	32

2018.483-LEA-15
2018.277A-LEA-15

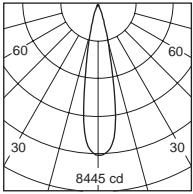

h (m)	D (m)	E (lx)
20°		
1.0	0.38	8437
2.0	0.77	2109
3.0	1.15	937
4.0	1.54	527
5.0	1.92	337

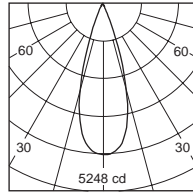

h (m)	D (m)	E (lx)
30°		
1.0	0.59	5246
2.0	1.17	1312
3.0	1.76	582
4.0	2.34	327
5.0	2.93	209

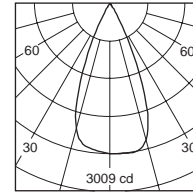

h (m)	D (m)	E (lx)
45°		
1.0	0.82	2999
2.0	1.63	749
3.0	2.45	333
4.0	3.26	187
5.0	4.08	120

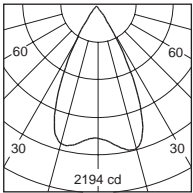

h (m)	D (m)	E (lx)
55°		
1.0	1.06	2014
2.0	2.12	503
3.0	3.18	223
4.0	4.25	125
5.0	5.31	80

2018.483-LEA15DW
2018.277A-LEA15DW

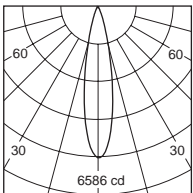

h (m)	D (m)	E (lx)
20°		
1.0	0.37	6596
2.0	0.74	1649
3.0	1.10	732
4.0	1.47	412
5.0	1.84	263

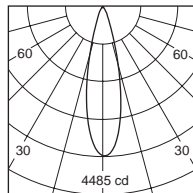

h (m)	D (m)	E (lx)
25°		
1.0	0.45	4486
2.0	0.90	1121
3.0	1.35	498
4.0	1.80	280
5.0	2.25	179

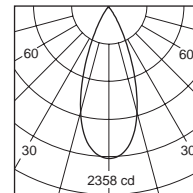

h (m)	D (m)	E (lx)
40°		
1.0	0.72	2359
2.0	1.44	589
3.0	2.15	262
4.0	2.87	147
5.0	3.59	94

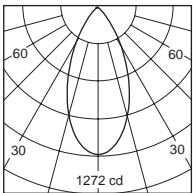

h (m)	D (m)	E (lx)
50°		
1.0	0.89	1273
2.0	1.77	318
3.0	2.66	141
4.0	3.55	79
5.0	4.44	50

2018.495-LEA-15
2018.295A-LEA-15

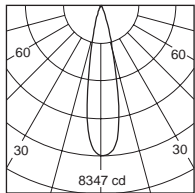

h(m)	D(m)	E(lx)
20°		
1.0	0.38	8345
2.0	0.77	2086
3.0	1.15	927
4.0	1.53	521
5.0	1.91	333

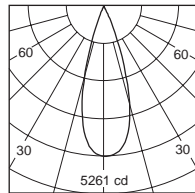

h(m)	D(m)	E(lx)
30°		
1.0	0.59	5262
2.0	1.18	1316
3.0	1.77	584
4.0	2.36	328
5.0	2.95	210

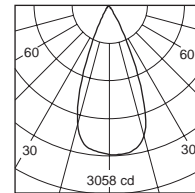

h(m)	D(m)	E(lx)
45°		
1.0	0.80	3244
2.0	1.60	761
3.0	2.40	338
4.0	3.20	190
5.0	4.01	121

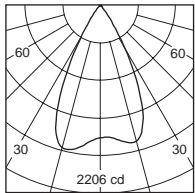

h(m)	D(m)	E(lx)
55°		
1.0	1.05	2042
2.0	2.10	510
3.0	3.15	226
4.0	4.20	127
5.0	5.25	81

2018.495-LEA15DW
2018.295A-LEA15DW

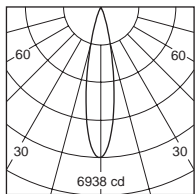

h(m)	D(m)	E(lx)
20°		
1.0	0.37	6941
2.0	0.74	1735
3.0	1.11	771
4.0	1.48	433
5.0	1.85	277

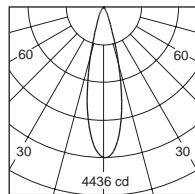

h(m)	D(m)	E(lx)
25°		
1.0	0.45	4437
2.0	0.90	1109
3.0	1.34	493
4.0	1.79	277
5.0	2.24	177

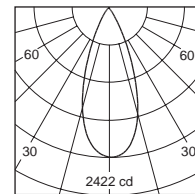

h(m)	D(m)	E(lx)
40°		
1.0	0.70	2420
2.0	1.41	605
3.0	2.11	268
4.0	2.82	151
5.0	3.52	96

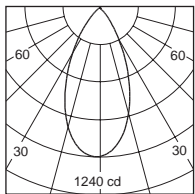

h(m)	D(m)	E(lx)
50°		
1.0	0.89	1239
2.0	1.78	309
3.0	2.67	137
4.0	3.57	77
5.0	4.46	49

2018.484-LEA-15
2018.278A-LEA-15

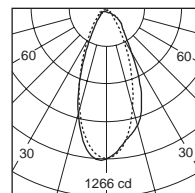

h(m)	D(m)	E(lx)
Wallwash		
1.0	0.78	1264
2.0	1.56	316
3.0	2.34	140
4.0	3.12	79
5.0	3.90	57

2018.484-LEA15DW
2018.278A-LEA15DW

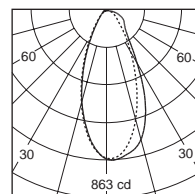

h(m)	D(m)	E(lx)
Wallwash		
1.0	0.76	859
2.0	1.58	214
3.0	2.38	95
4.0	3.17	53
5.0	3.96	34







EPIC-135

4.5"

Round / Square

Fixed
Adjustable
Wallwash

EPIC-135-RTF



Article number	2018.464-ACOT-73-AM	
	NON-IC	IC
Fixture Consumption	45W	35W
Current	1050 (mA)	850 (mA)
Delivered Lumen	3305 (lm)	2775 (lm)
HE Delivered Lumen*	4164 (lm)	3496 (lm)
Beam Angle	20°/30°/45°/55°/70° (Lens)	
CCT	3000K	
CRI	90+	
Driver Model	PUP40A-1WMC-1200	

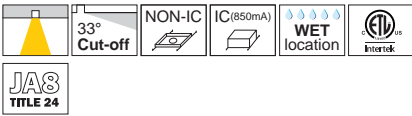

Dimmable

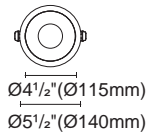
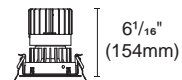

⊘ Cut out : 5 1/32" (128mm)

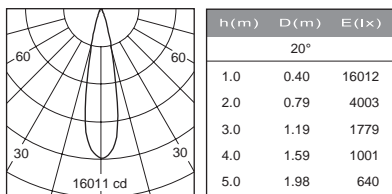

EPIC-135-RTA



Article number	2018.463-ACOT-73-AM	
	NON-IC	IC
Fixture Consumption	45W	35W
Current	1050 (mA)	850 (mA)
Delivered Lumen	3190 (lm)	2721 (lm)
HE Delivered Lumen*	4019 (lm)	3428 (lm)
Beam Angle	20°/30°/45°/55°/70° (Lens)	
CCT	3000K	
CRI	90+	
Driver Model	PUP40A-1WMC-1200	

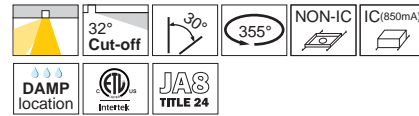

Dimmable

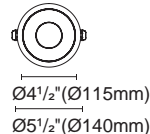
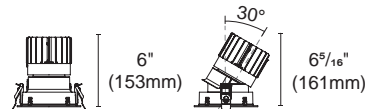

⊘ Cut out : 5 1/32" (128mm)

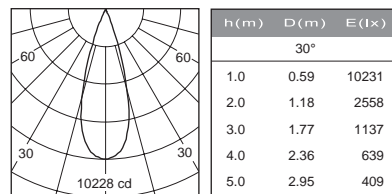

EPIC-135-RTW



Article number	2218.146-ACOT-73-AM	
	NON-IC	IC
Fixture Consumption	45W	35W
Current	1050 (mA)	850 (mA)
Delivered Lumen	1961 (lm)	1667 (lm)
HE Delivered Lumen*	2470 (lm)	2100 (lm)
Beam Angle	Wallwash (Lens)	
CCT	3000K	
CRI	90+	
Driver Model	PUP40A-1WMC-1200	

*Wallwash lens — best optical matching angle: 36°

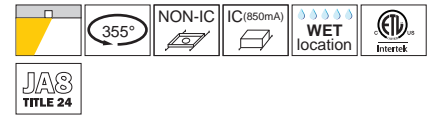

Dimmable

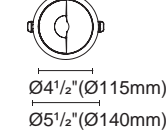

⊘ Cut out : 5 1/32" (128mm)

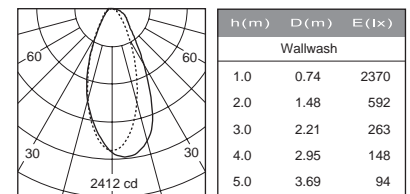

Accessories



Accessories are not suitable for wallwash fixtures

EPIC-135-RTLF

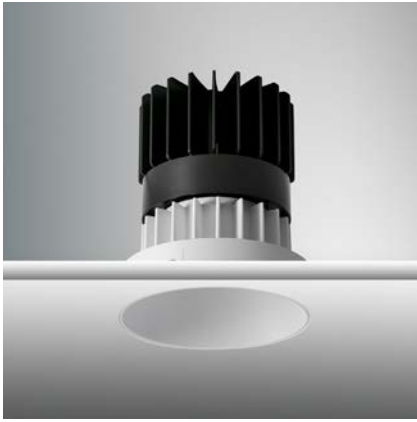

Article number	2018.256F-ACOT-73-AM	
	NON-IC	IC
Fixture Consumption	45W	35W
Current	1050 (mA)	850 (mA)
Delivered Lumen	3305 (lm)	2775 (lm)
HE Delivered Lumen*	4164 (lm)	3496 (lm)
Beam Angle	20°/30°/45°/55°/70° (Lens)	
CCT	3000K	
CRI	90+	
Driver Model	PUP40A-1WMC-1200	

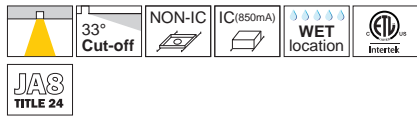

Dimmable

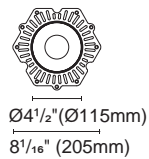
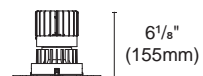

⊕ Cut out : 5 1/32" (128mm)

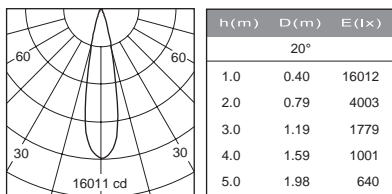

EPIC-135-RTLA



Article number	2018.255F-ACOT-73-AM	
	NON-IC	IC
Fixture Consumption	45W	35W
Current	1050 (mA)	850 (mA)
Delivered Lumen	3190 (lm)	2721 (lm)
HE Delivered Lumen*	4019 (lm)	3428 (lm)
Beam Angle	20°/30°/45°/55°/70° (Lens)	
CCT	3000K	
CRI	90+	
Driver Model	PUP40A-1WMC-1200	

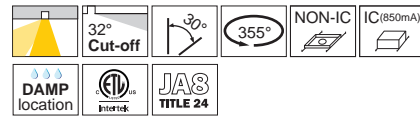

Dimmable

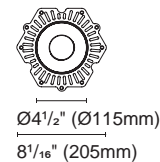
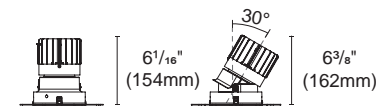

⊕ Cut out : 5 1/32" (128mm)

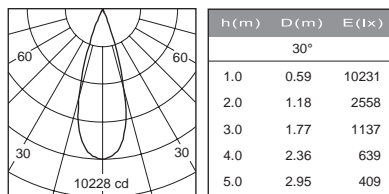

EPIC-135-RTLW

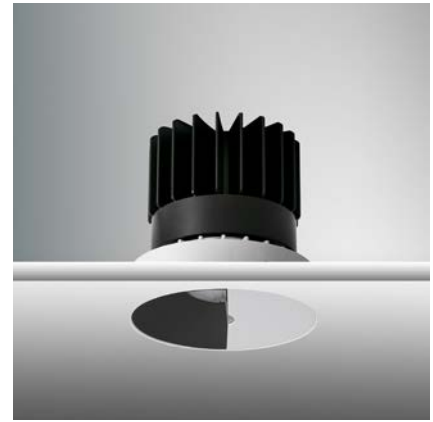

Article number	2218.218F-ACOT-73-AM	
	NON-IC	IC
Fixture Consumption	45W	35W
Current	1050 (mA)	850 (mA)
Delivered Lumen	1961 (lm)	1667 (lm)
HE Delivered Lumen*	2470 (lm)	2100 (lm)
Beam Angle	Wallwash (Lens)	
CCT	3000K	
CRI	90+	
Driver Model	PUP40A-1WMC-1200	

*Wallwash lens — best optical matching angle: 36°

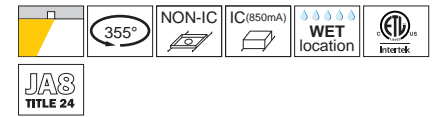

Dimmable

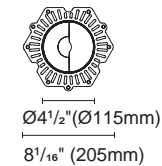

⊕ Cut out : 5 1/32" (128mm)

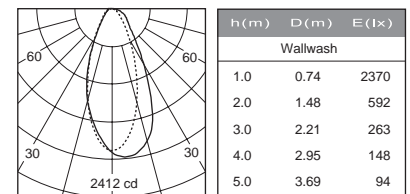

Accessories



Accessories are not suitable for wallwash fixtures

EPIC-135-STF

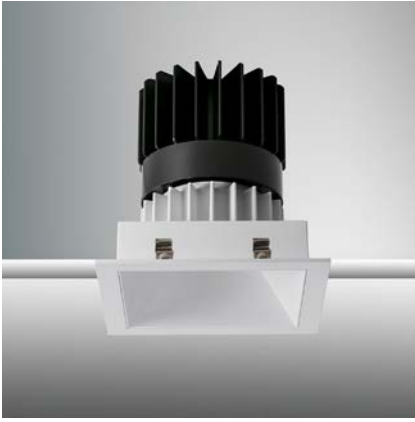

Article number	2018.466-ACOT-73-AM	
	NON-IC	IC
Fixture Consumption	45W	35W
Current	1050 (mA)	850 (mA)
Delivered Lumen	3258 (lm)	2810 (lm)
HE Delivered Lumen*	4105 (lm)	3540 (lm)
Beam Angle	20°/30°/45°/55°/70° (Lens)	
CCT	3000K	
CRI	90+	
Driver Model	PUP40A-1WMC-1200	

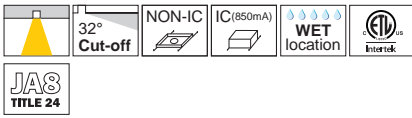

Dimmable

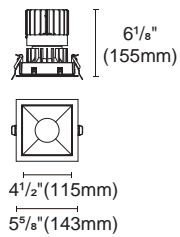

Cut out : 5 1/32" X 5 1/32" (128X128mm)

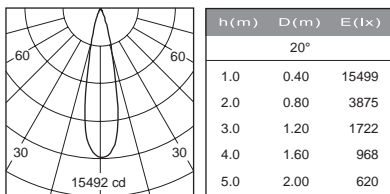

EPIC-135-STA



Article number	2018.465-ACOT-73-AM	
	NON-IC	IC
Fixture Consumption	45W	35W
Current	1050 (mA)	850 (mA)
Delivered Lumen	3242 (lm)	2765 (lm)
HE Delivered Lumen*	4084 (lm)	3483 (lm)
Beam Angle	20°/30°/45°/55°/70° (Lens)	
CCT	3000K	
CRI	90+	
Driver Model	PUP40A-1WMC-1200	

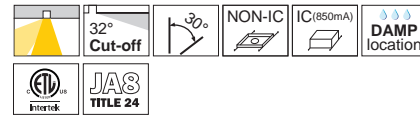

Dimmable

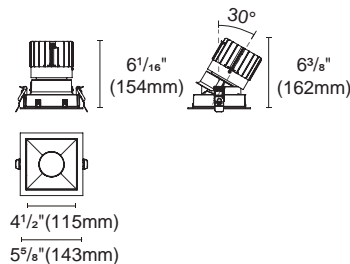

Cut out : 5 1/32" X 5 1/32" (128X128mm)

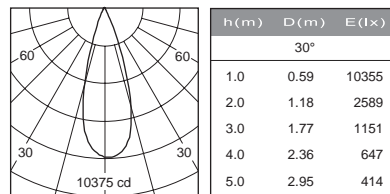

EPIC-135-STW



Article number	2218.147-ACOT-73-AM	
	NON-IC	IC
Fixture Consumption	45W	35W
Current	1050 (mA)	850 (mA)
Delivered Lumen	2017 (lm)	1674 (lm)
HE Delivered Lumen*	2541 (lm)	2109 (lm)
Beam Angle	Wallwash (Lens)	
CCT	3000K	
CRI	90+	
Driver Model	PUP40A-1WMC-1200	

*Wallwash lens — best optical matching angle: 36°



Dimmable

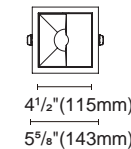

Cut out : 5 1/32" X 5 1/32" (128X128mm)

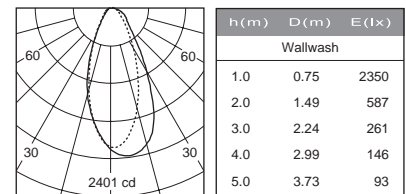

Accessories



Accessories are not suitable for wallwash fixtures

EPIC-135-STLF

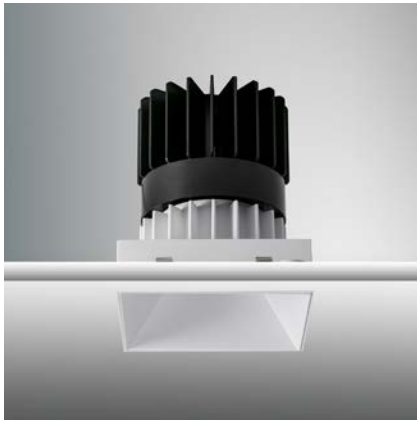

EPIC-135-STLA



EPIC-135-STLW

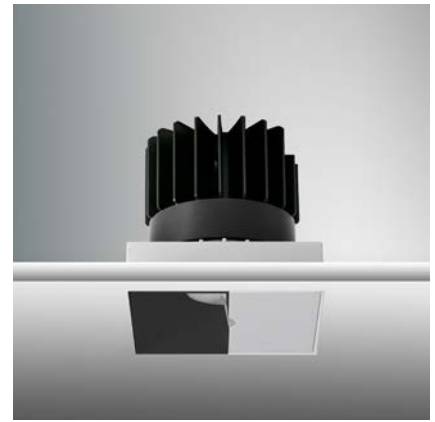

Article number	2018.258A-ACOT-73-AM	
	NON-IC	IC
Fixture Consumption	45W	35W
Current	1050 (mA)	850 (mA)
Delivered Lumen	3258 (lm)	2810 (lm)
HE Delivered Lumen*	4105 (lm)	3540 (lm)
Beam Angle	20°/30°/45°/55°/70° (Lens)	
CCT	3000K	
CRI	90+	
Driver Model	PUP40A-1WMC-1200	

Article number	2018.257A-ACOT-73-AM	
	NON-IC	IC
Fixture Consumption	45W	35W
Current	1050 (mA)	850 (mA)
Delivered Lumen	3242 (lm)	2765 (lm)
HE Delivered Lumen*	4084 (lm)	3483 (lm)
Beam Angle	20°/30°/45°/55°/70° (Lens)	
CCT	3000K	
CRI	90+	
Driver Model	PUP40A-1WMC-1200	

Article number	2218.219A-ACOT-73-AM	
	NON-IC	IC
Fixture Consumption	45W	35W
Current	1050 (mA)	850 (mA)
Delivered Lumen	2017 (lm)	1674 (lm)
HE Delivered Lumen*	2541 (lm)	2109 (lm)
Beam Angle	Wallwash (Lens)	
CCT	3000K	
CRI	90+	
Driver Model	PUP40A-1WMC-1200	

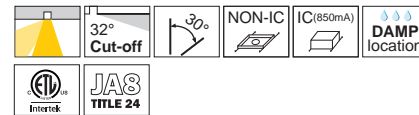
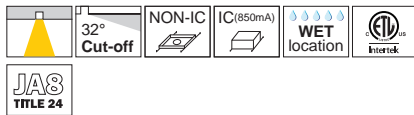

*Wallwash lens — best optical matching angle: 36°

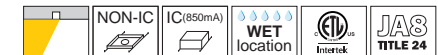

Dimmable



Dimmable



Dimmable

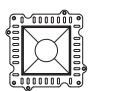

4 1/2" (115mm)
7 7/8" (200mm)



4 1/2" (115mm)
7 7/8" (200mm)

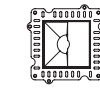

4 1/2" (115mm)
7 7/8" (200mm)

Cut out : 5 1/32" X 5 1/32" (128X128mm)

Cut out : 5 1/32" X 5 1/32" (128X128mm)

Cut out : 5 1/32" X 5 1/32" (128X128mm)

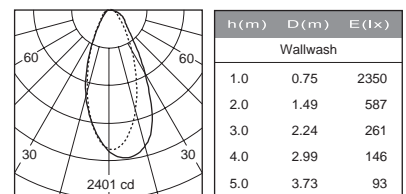
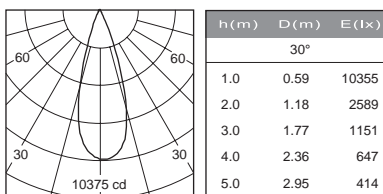
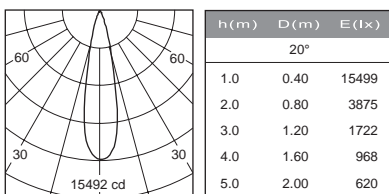

Accessories



Accessories are not suitable for wallwash fixtures

INSTALLATION OPTIONS



ACCG-28B-PUP10A-1WMC-350 0/1-10V
 ACCG-28B-PUP10D-1WMC-350 DALI
 ACCG-28B-PUP10T-1LMC-350 TRIAC
 for EPIC65-2"
 Type: Gear box

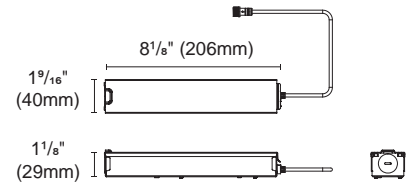

Internal space dimension:
 L 4 1/4" (108mm) X W 1 3/8" (35mm) X H 1" (26mm)



ACCG-22B-PUP20A-1WMC 0/1-10V
 ACCG-22B-PUP20D-1WMC DALI
 ACCG-22B-PUP20T-1LMC TRIAC
 for EPIC85-2.8"
 EPIC110-3.5" (18-21W)
 Type: Gear box

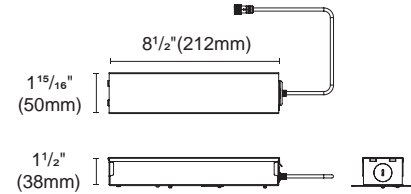

Internal space dimension:
 L 8 1/4" (209mm) X W 1 7/8" (48mm) X H 1 5/16" (33mm)



ACCG-35B-PUP20A-1WMC 0/1-10V
 ACCG-35B-PUP20D-1WMC DALI
 ACCG-35B-PUP20T-1LMC TRIAC
 for EPIC85-2.8"
 EPIC110-3.5" (18-21W)
 Type: Gear box

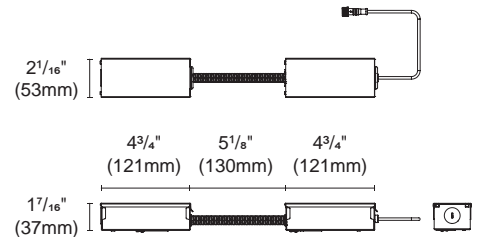

* Use with low ceilings



ACCG-16B-PUP40A-1WMC-850 0/1-10V
 ACCG-16B-PUP40D-1WMC-850 DALI
 ACCG-16B-PUP40T-1LMC-850 TRIAC
 for EPIC110-3.5" (30W)
 Type: Gear box

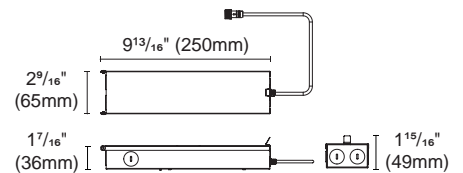

Internal space dimension:
 L 9 13/16" (250mm) X W 2 1/2" (64mm) X H 1 5/16" (34mm)

* For single fixture connection only, not available for parallel multiple connection

ACCG-16B-PUP40A-1WMC-1200 0/1-10V
 ACCG-16B-PUP40D-1WMC-1200 DALI
 ACCG-16B-PUP40T-1LMC-1200 TRIAC
 for EPIC135-4.5"
 Type: Gear box



ACCH-12-60 for EPIC65-2"
Type: New construction plate

Cut out:

Round : $\varnothing 2^{12}/_{32}$ " ($\varnothing 60$ mm)

Square : $\square 2^{12}/_{32}$ " ($\square 60$ mm)

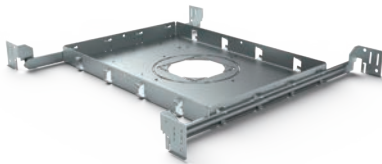
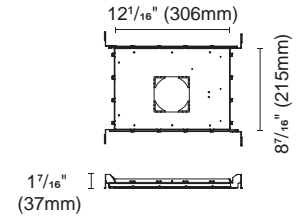

ACCH-12-80 for EPIC85-2.8"
Type: New construction plate

Cut out:

Round : $\varnothing 3^{5}/_{32}$ " ($\varnothing 80$ mm)

Square : $\square 3^{5}/_{32}$ " ($\square 80$ mm)

Also for Millwork

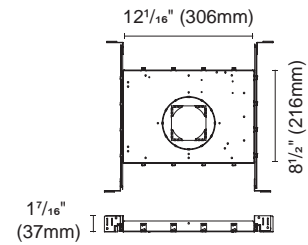

ACCH-12H-100 for EPIC110-3.5"
Type: New construction plate

Cut out:

Round : $\varnothing 3^{30}/_{32}$ " ($\varnothing 100$ mm)

Square : $\square 3^{30}/_{32}$ " ($\square 100$ mm)

Also for Millwork

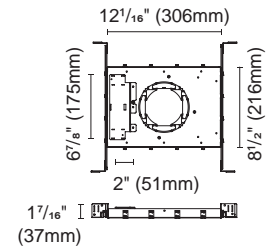

ACCH-12H-125
for EPIC135-4.5"
Type: New construction plate

Cut out:

Round : $\varnothing 5^{1}/_{32}$ " ($\varnothing 128$ mm)

Square : $\square 5^{1}/_{32}$ " ($\square 128$ mm)

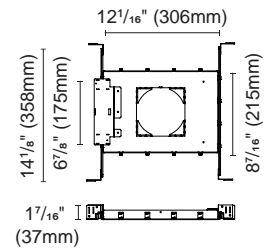

INSTALLATION OPTIONS

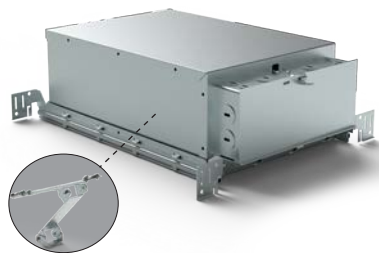

Driver is secured on patent designed bracket

ACCH-12D-60-PUP10A-1WMC-350 0/1-10V
 ACCH-12D-60-PUP10D-1WMC-350 DALI
 ACCH-12D-60-PUP10T-1LMC-350 TRIAC

for EPIC65-2"

Type: IC Box

Cut out:

Round : $\varnothing 2^{12}/_{32}$ " ($\varnothing 60$ mm)

Square : $\square 2^{12}/_{32}$ " ($\square 60$ mm)

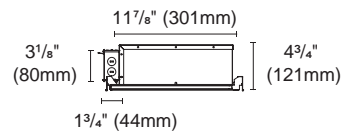
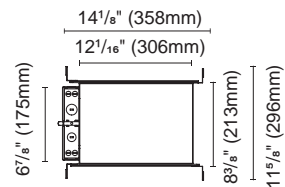

ACCH-12D-80-PUP20A-1WMC 0/1-10V
 ACCH-12D-80-PUP20D-1WMC DALI
 ACCH-12D-80-PUP20T-1LMC TRIAC
 for EPIC85-2.8"

Type: IC Box

Cut out:

Round : $\varnothing 3^{5}/_{32}$ " ($\varnothing 80$ mm)

Square : $\square 3^{5}/_{32}$ " ($\square 80$ mm)

Also for Millwork



ACCH-12B-100-PUP20A-1WMC 0/1-10V
 ACCH-12B-100-PUP20D-1WMC DALI
 ACCH-12B-100-PUP20T-1LMC TRIAC
 for EPIC110-3.5" (18-21W)

Type: IC Box

Cut out:

Round : $\varnothing 3^{30}/_{32}$ " ($\varnothing 100$ mm)

Square : $\square 3^{30}/_{32}$ " ($\square 100$ mm)

Also for Millwork

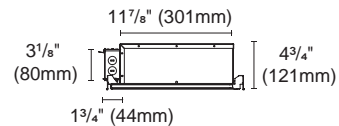
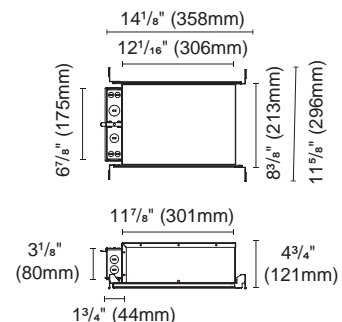

ACCH-7B-100-PUP40A-1WMC-850 0/1-10V
 ACCH-7B-100-PUP40D-1WMC-850 DALI
 ACCH-7B-100-PUP40T-1LMC-850 TRIAC
 for EPIC110-3.5" (25W)

Type: IC Box

Cut out:

Round : $\varnothing 3^{30}/_{32}$ " ($\varnothing 100$ mm)

Square : $\square 3^{30}/_{32}$ " ($\square 100$ mm)

Also for Millwork

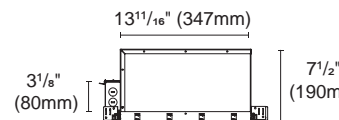
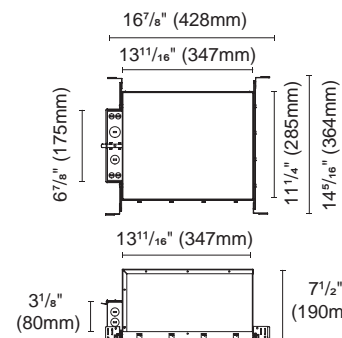

ACCH-7B-125-PUP40A-1WMC-1200 0/1-10V
 ACCH-7B-125-PUP40D-1WMC-1200 DALI
 ACCH-7B-125-PUP40T-1LMC-1200 TRIAC
 for EPIC135-4.5"

Type: IC Box

Cut out:

Round : $\varnothing 5^{1}/_{32}$ " ($\varnothing 128$ mm)

Square : $\square 5^{1}/_{32}$ " ($\square 128$ mm)



ACCI-3
Type: Emergency battery holder
For BillDa emergency led driver-
Model NO. BLD-HM08D-YYY
BLD-HM15D-YYY
BLD-HM20D-YYY
BLD-HM25D-YYY

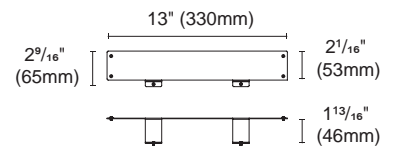

ACCI-5
Type: Remodel stand

