

BRANKO SERIES (AM)



BRANKO (AM)

BRANKO is a modern, sleek, efficient indoor lighting solution with convenient installation and versatility. It is designed to provide even and soft illumination, avoiding harsh glare. They are commonly used for indoor lighting in spaces like living rooms, bedrooms, providing comfortable illumination.

Shape
(Baffle Size)



Round
2"

Round
2.8"

Round
3.5"



Square
2.8"

Square
3.5"

Mountings



Recessed
Trim

Recessed
Trimless

Millwork

Light distributions



Fixed

Adjustable

BRANKO
recessed downlights



	2" Fixed	2" Adjustable	2.8" Fixed	2.8" Adjustable
Round				
Cone baffle				
Trim-A				
Trim-B				
Trimless				
Mill work				
Pinhole baffle				
Trim-A				
Trim-B				
Trimless				
Millwork				
Square				
Cone baffle				
Trim-A				
Trim-B				
Trimless				
Millwork				
Pinhole baffle				
Trim-A				
Trim-B				
Trimless				
Millwork				



LEA-15



LEA-15-DW
Dim to warm



ACOT-84-AM

3.5"
Fixed

3.5"
Adjustable

Round

Cone baffle

Trim-A



Trim-B



Trimless



Millwork



Pinhole baffle

Trim-A



Trim-B



Trimless



Millwork



Square

Cone baffle

Trim-A



Trim-B



Trimless



Millwork



Pinhole baffle

Trim-A



Trim-B



Trimless



Millwork





Cone baffle

It is a multifunctional accent light that can highlight a single object or architectural element.

Available in fixed and adjustable versions, while the adjustable version can be precisely set to tilt at an angle of up to 30 degrees, so the light will be emitted exactly where you want it.

There are also different accessories to choose from, adding more flexibility and freedom for lighting designers. Suitable for hotels and residences.

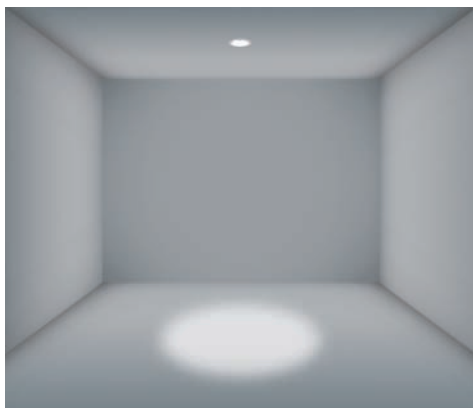
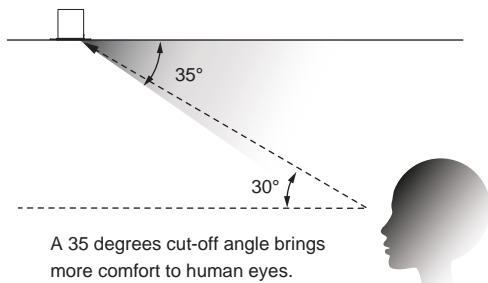

Pinhole baffle

It is a multifunctional accent light that can highlight a single object or architectural element. To further reduce the visual impact on the ceiling, the pin hole baffle is used to bring the luminaire flush with the ceiling for added glare protection and a 40 degree cut-off angle.

Fixed and adjustable functions are available, while the adjustable version can be precisely set to a tilt angle of up to 30 degrees, so the light will be emitted exactly where you want it.

There are also different accessories to choose from, adding more flexibility and freedom for lighting designers. Suitable for hotels and residences.

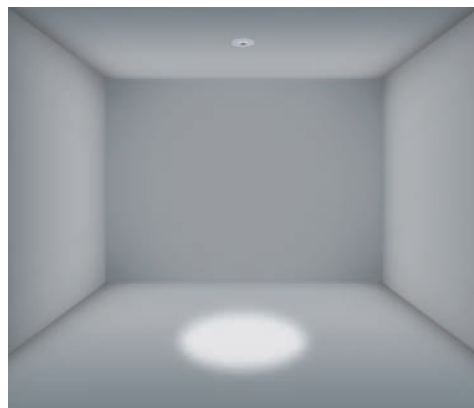
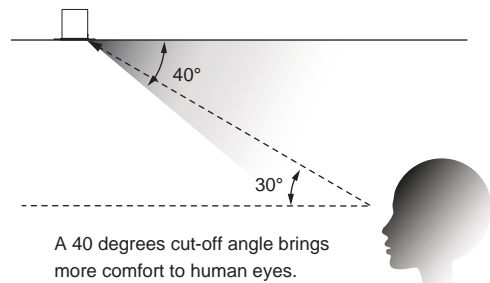





BRANKO-65

2"

Round

Fixed
Adjustable

BRANKO-A-65C-RTF



Article number	2318.157-LEA-13
Fixture Consumption	12W
Current	250 (mA)
Delivered Lumen	622 (lm)
HE Delivered Lumen*	733 (lm)
Beam Angle	15°/24°/36°/40° (Lens)
CCT	3000K
CRI	90+
Driver Model	PUP10A-1WMC-350

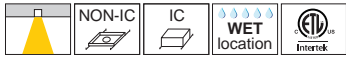

Dimmable

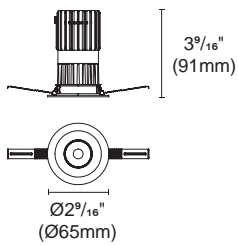

⊕ Cut out : 2¹²/₃₂" (60mm)

Accessories

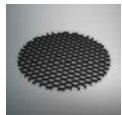

ACHO-6
Honeycomb louver

BRANKO-B-65C-RTF



Article number	2318.116-LEA-13
Fixture Consumption	12W
Current	250 (mA)
Delivered Lumen	622 (lm)
HE Delivered Lumen*	733 (lm)
Beam Angle	15°/24°/36°/40° (Lens)
CCT	3000K
CRI	90+
Driver Model	PUP10A-1WMC-350

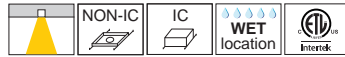

Dimmable

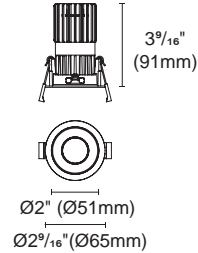

⊕ Cut out : 2¹²/₃₂" (60mm)

Accessories

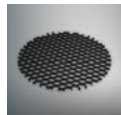

ACHO-6
Honeycomb louver

BRANKO-B-65C-RTL

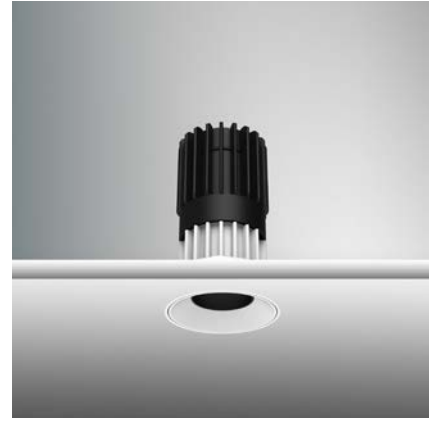

Article number	2318.210F-LEA-13
Fixture Consumption	12W
Current	250 (mA)
Delivered Lumen	622 (lm)
HE Delivered Lumen*	733 (lm)
Beam Angle	15°/24°/36°/40° (Lens)
CCT	3000K
CRI	90+
Driver Model	PUP10A-1WMC-350

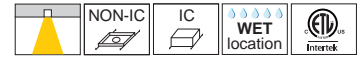

Dimmable

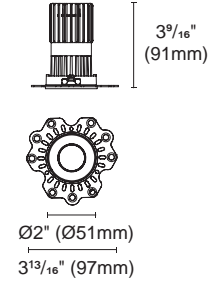

⊕ Cut out : 2¹²/₃₂" (60mm)

Accessories

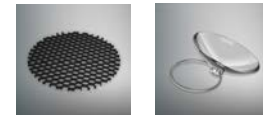

ACHO-6
Honeycomb louver
 ACOT-107
Suction cup

BRANKO-A-65C-RTA



Article number	2318.159-LEA-13
Fixture Consumption	12W
Current	250 (mA)
Delivered Lumen	603 (lm)
HE Delivered Lumen*	711 (lm)
Beam Angle	15°/24°/36°/40° (Lens)
CCT	3000K
CRI	90+
Driver Model	PUP10A-1WMC-350



Dimmable

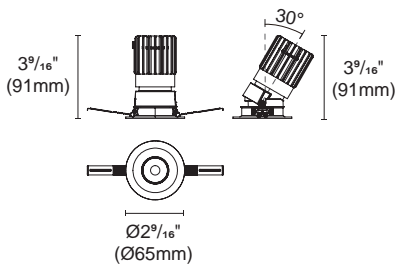

⊗ Cut out : 2 12/32" (60mm)

Accessories

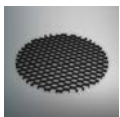

ACHO-6
Honeycomb louver

BRANKO-B-65C-RTA



Article number	2318.117-LEA-13
Fixture Consumption	12W
Current	250 (mA)
Delivered Lumen	603 (lm)
HE Delivered Lumen*	711 (lm)
Beam Angle	15°/24°/36°/40° (Lens)
CCT	3000K
CRI	90+
Driver Model	PUP10A-1WMC-350



Dimmable

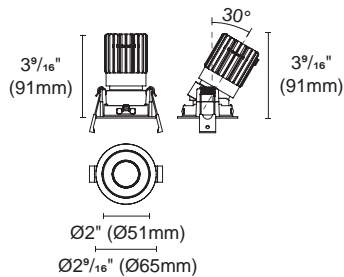

⊗ Cut out : 2 12/32" (60mm)

Accessories

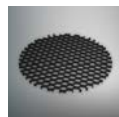

ACHO-6
Honeycomb louver

BRANKO-B-65C-RTLA



Article number	2318.211F-LEA-13
Fixture Consumption	12W
Current	250 (mA)
Delivered Lumen	603 (lm)
HE Delivered Lumen*	711 (lm)
Beam Angle	15°/24°/36°/40° (Lens)
CCT	3000K
CRI	90+
Driver Model	PUP10A-1WMC-350



Dimmable

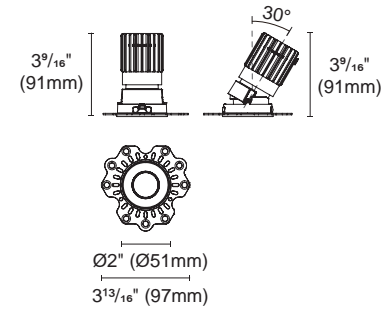

⊗ Cut out : 2 12/32" (60mm)

Accessories



ACHO-6
Honeycomb louver

BRANKO-A-65P-RTF



Article number	2318.158-LEA-13
Fixture Consumption	12W
Current	250 (mA)
Delivered Lumen	525 (lm)
HE Delivered Lumen*	619 (lm)
Beam Angle	15°/24°/30°/35° (Lens)
CCT	3000K
CRI	90+
Driver Model	PUP10A-1WMC-350

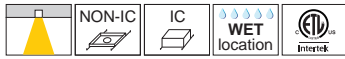

Dimmable

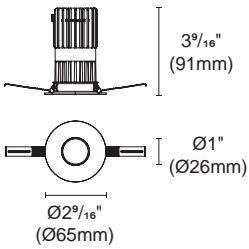

⊗ Cut out : 2 1/2 / 32" (60mm)

Accessories

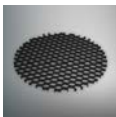

ACHO-6
Honeycomb louver

BRANKO-B-65-RTF



Article number	2318.120-LEA-13
Fixture Consumption	12W
Current	250 (mA)
Delivered Lumen	525 (lm)
HE Delivered Lumen*	619 (lm)
Beam Angle	15°/24°/30°/35° (Lens)
CCT	3000K
CRI	90+
Driver Model	PUP10A-1WMC-350

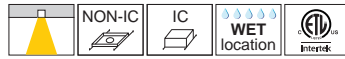

Dimmable

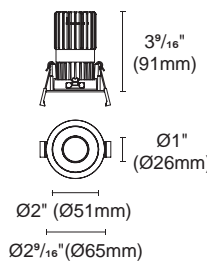

⊗ Cut out : 2 1/2 / 32" (60mm)

Accessories

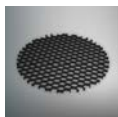

ACHO-6
Honeycomb louver

BRANKO-B-65-RTL

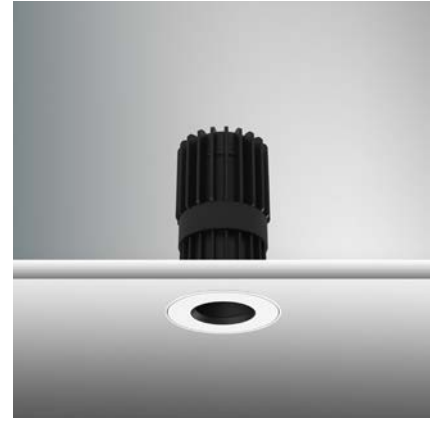

Article number	2318.212F-LEA-13
Fixture Consumption	12W
Current	250 (mA)
Delivered Lumen	525 (lm)
HE Delivered Lumen*	619 (lm)
Beam Angle	15°/24°/30°/35° (Lens)
CCT	3000K
CRI	90+
Driver Model	PUP10A-1WMC-350

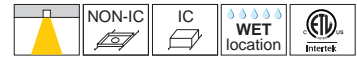

Dimmable



⊗ Cut out : 2 1/2 / 32" (60mm)

Accessories

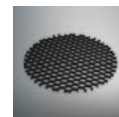

ACHO-6
Honeycomb louver

BRANKO-A-65P-RTA



Article number	2318.160-LEA-13
Fixture Consumption	12W
Current	250 (mA)
Delivered Lumen	578 (lm)
HE Delivered Lumen*	682 (lm)
Beam Angle	15°/24°/30°/40° (Lens)
CCT	3000K
CRI	90+
Driver Model	PUP10A-1WMC-350

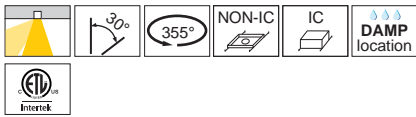

Dimmable

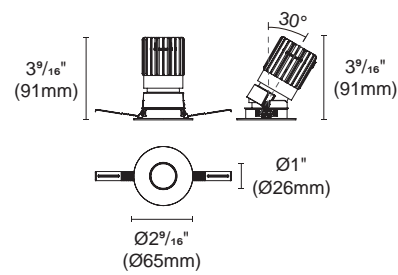

⊗ Cut out : 2 12/32" (60mm)

Accessories



ACHO-6 Honeycomb louver

BRANKO-B-65-RTA



Article number	2318.121-LEA-13
Fixture Consumption	12W
Current	250 (mA)
Delivered Lumen	578 (lm)
HE Delivered Lumen*	682 (lm)
Beam Angle	15°/24°/30°/40° (Lens)
CCT	3000K
CRI	90+
Driver Model	PUP10A-1WMC-350

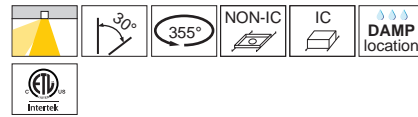

Dimmable

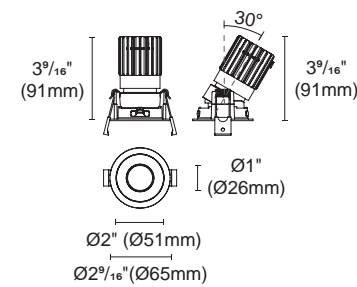

⊗ Cut out : 2 12/32" (60mm)

Accessories

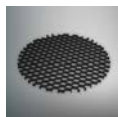

ACHO-6 Honeycomb louver

BRANKO-B-65-RTLA



Article number	2318.213F-LEA-13
Fixture Consumption	12W
Current	250 (mA)
Delivered Lumen	578 (lm)
HE Delivered Lumen*	682 (lm)
Beam Angle	15°/24°/30°/40° (Lens)
CCT	3000K
CRI	90+
Driver Model	PUP10A-1WMC-350

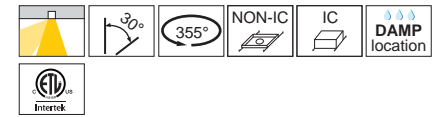

Dimmable

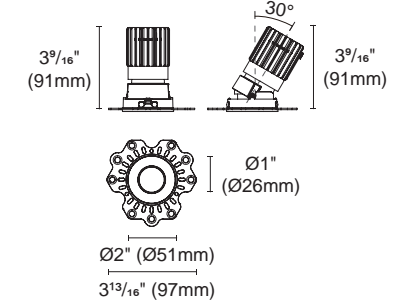

⊗ Cut out : 2 12/32" (60mm)

Accessories



ACHO-6 Honeycomb louver

 **15°**

Fixed UGR<9

2318.157-LEA-13
2318.116-LEA-13
2318.210F-LEA-13

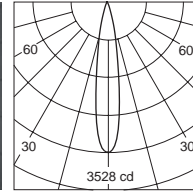
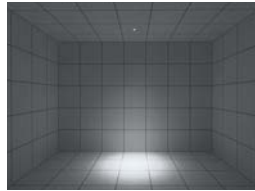

H(m)	D(m)	E(lx)
15°		
1.0	0.30	2480
2.0	0.60	620
3.0	0.90	275
4.0	1.20	155
5.0	1.50	99

 **24°**

Fixed UGR<7

2318.157-LEA-13
2318.116-LEA-13
2318.210F-LEA-13

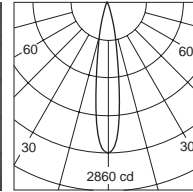
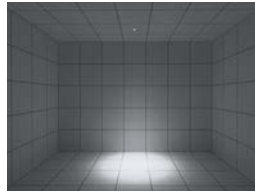

H(m)	D(m)	E(lx)
24°		
1.0	0.43	1938
2.0	0.86	484
3.0	1.29	215
4.0	1.73	121
5.0	2.16	77

 **36°**

Fixed UGR<12

2318.157-LEA-13
2318.116-LEA-13
2318.210F-LEA-13

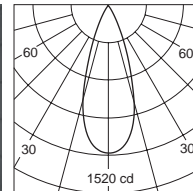
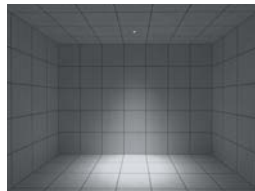

H(m)	D(m)	E(lx)
36°		
1.0	0.65	1077
2.0	1.30	269
3.0	1.94	119
4.0	2.59	67
5.0	3.24	43

 **40°**

Fixed UGR<17

2318.157-LEA-13
2318.116-LEA-13
2318.210F-LEA-13

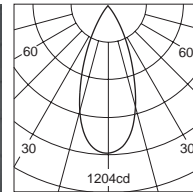
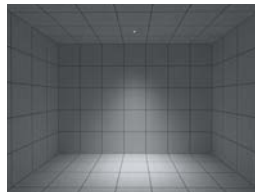

H(m)	D(m)	E(lx)
40°		
1.0	0.75	800
2.0	1.51	200
3.0	2.26	88
4.0	3.02	50
5.0	3.77	32

 **15°**

Adjustable

2318.159-LEA-13
2318.117-LEA-13
2318.211F-LEA-13

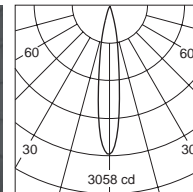
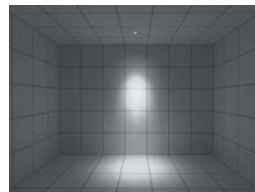

H(m)	D(m)	E(lx)
15°		
1.0	0.28	2163
2.0	0.56	540
3.0	0.84	240
4.0	1.12	135
5.0	1.40	86

 **24°**

Adjustable

2318.159-LEA-13
2318.117-LEA-13
2318.211F-LEA-13

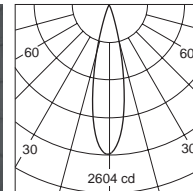
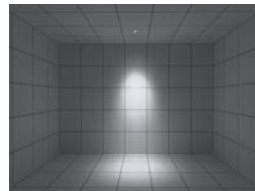

H(m)	D(m)	E(lx)
24°		
1.0	0.41	1812
2.0	0.82	453
3.0	1.23	201
4.0	1.64	113
5.0	2.05	72

 **36°**

Adjustable

2318.159-LEA-13
2318.117-LEA-13
2318.211F-LEA-13

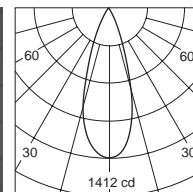
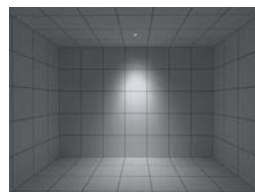

H(m)	D(m)	E(lx)
36°		
1.0	0.61	1003
2.0	1.22	250
3.0	1.82	111
4.0	2.43	62
5.0	3.04	40

 **40°**

Adjustable

2318.159-LEA-13
2318.117-LEA-13
2318.211F-LEA-13

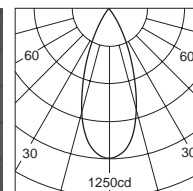
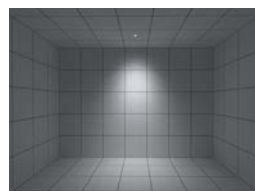

H(m)	D(m)	E(lx)
40°		
1.0	0.71	800
2.0	1.43	210
3.0	2.14	93
4.0	2.85	52
5.0	3.56	33

 **15°**

Fixed UGR<6

2318.158-LEA-13
2318.120-LEA-13
2318.212F-LEA-13

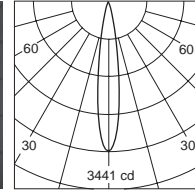
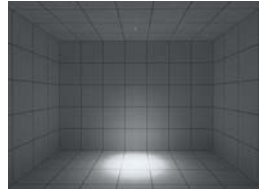

H(m)	D(m)	E(lx)
15°		
1.0	0.28	2469
2.0	0.56	617
3.0	0.84	274
4.0	1.12	154
5.0	1.40	98

 **24°**

Fixed UGR<7

2318.158-LEA-13
2318.120-LEA-13
2318.212F-LEA-13

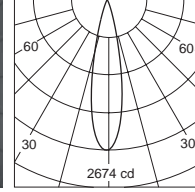
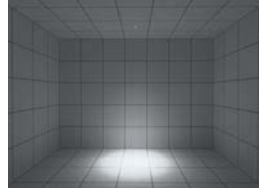

H(m)	D(m)	E(lx)
24°		
1.0	0.39	1811
2.0	0.79	452
3.0	1.18	201
4.0	1.57	113
5.0	1.96	72

 **30°**

Fixed UGR<13

2318.158-LEA-13
2318.120-LEA-13
2318.212F-LEA-13

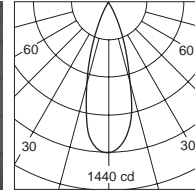
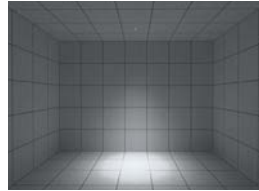

H(m)	D(m)	E(lx)
30°		
1.0	0.58	975
2.0	1.15	243
3.0	1.73	108
4.0	2.30	60
5.0	2.88	39

 **35°**

Fixed UGR<19

2318.158-LEA-13
2318.120-LEA-13
2318.212F-LEA-13

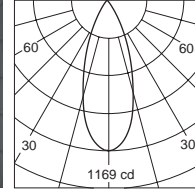
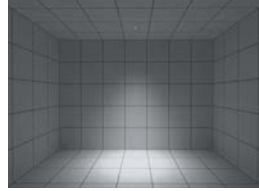

H(m)	D(m)	E(lx)
35°		
1.0	0.67	776
2.0	1.35	194
3.0	2.02	86
4.0	2.70	48
5.0	3.37	31

 **15°**

Adjustable

2318.160-LEA-13
2318.121-LEA-13
2318.213F-LEA-13

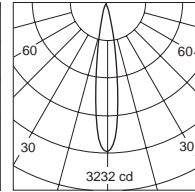
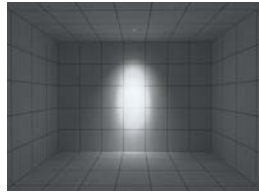

H(m)	D(m)	E(lx)
15°		
1.0	0.29	2176
2.0	0.57	544
3.0	0.86	241
4.0	1.14	136
5.0	1.43	87

 **24°**

Adjustable

2318.160-LEA-13
2318.121-LEA-13
2318.213F-LEA-13

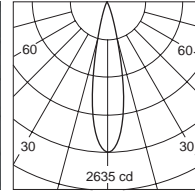
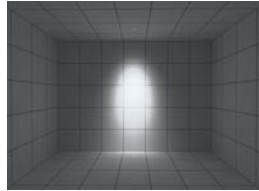

H(m)	D(m)	E(lx)
24°		
1.0	0.39	2637
2.0	0.78	659
3.0	1.17	293
4.0	1.56	164
5.0	1.95	105

 **30°**

Adjustable

2318.160-LEA-13
2318.121-LEA-13
2318.213F-LEA-13

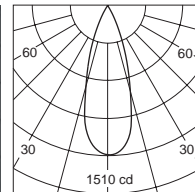
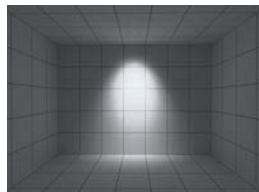

H(m)	D(m)	E(lx)
30°		
1.0	0.59	1047
2.0	1.18	261
3.0	1.77	116
4.0	2.36	65
5.0	2.95	41

 **40°**

Adjustable

2318.160-LEA-13
2318.121-LEA-13
2318.213F-LEA-13

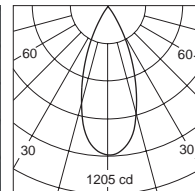
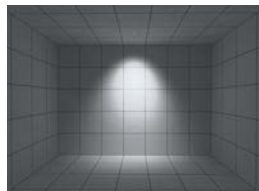

H(m)	D(m)	E(lx)
40°		
1.0	0.73	785
2.0	1.46	196
3.0	2.19	87
4.0	2.93	49
5.0	3.66	31



BRANKO-85

2.8"

Round / Square

Fixed
Adjustable

BRANKO-A-85C-RTF



Article number	2318.161-LEA-14	
	NON-IC	IC
Fixture Consumption	20W	15W
Current	450 (mA)	350 (mA)
Delivered Lumen	1231 (lm)	1027 (lm)
HE Delivered Lumen*	1538 (lm)	1283 (lm)
Beam Angle	25°/30°/45°/55° (Lens)	
CCT	3000K	
CRI	90+	
Driver Model	PUP20A-1WMC	
Article number	2318.161-LEA-14-DW	
Fixture Consumption	15W	
Current	350 (mA)	
Delivered Lumen	909 (lm)	
Beam Angle	25°/30°/45°/55° (Lens)	
CCT	1800-3000K	
CRI	90+	
Driver Model	PUP20A-1WMC	

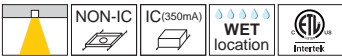

Dimmable

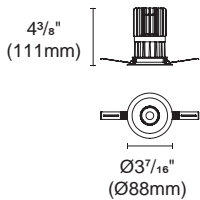

Cut out : 3 5/32" (80mm)

Accessories



ACHO-5 Honeycomb louver

BRANKO-B-85C-RTF



Article number	2318.110-LEA-14	
	NON-IC	IC
Fixture Consumption	20W	15W
Current	450 (mA)	350 (mA)
Delivered Lumen	1231 (lm)	1027 (lm)
HE Delivered Lumen*	1538 (lm)	1283 (lm)
Beam Angle	25°/30°/45°/55° (Lens)	
CCT	3000K	
CRI	90+	
Driver Model	PUP20A-1WMC	
Article number	2318.110-LEA-14-DW	
Fixture Consumption	15W	
Current	350 (mA)	
Delivered Lumen	909 (lm)	
Beam Angle	25°/30°/45°/55° (Lens)	
CCT	1800-3000K	
CRI	90+	
Driver Model	PUP20A-1WMC	

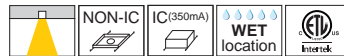

Dimmable

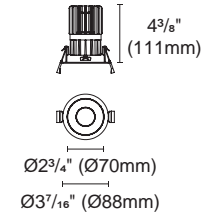

Cut out : 3 5/32" (80mm)

Accessories



ACHO-5 Honeycomb louver

BRANKO-B-85C-RTL

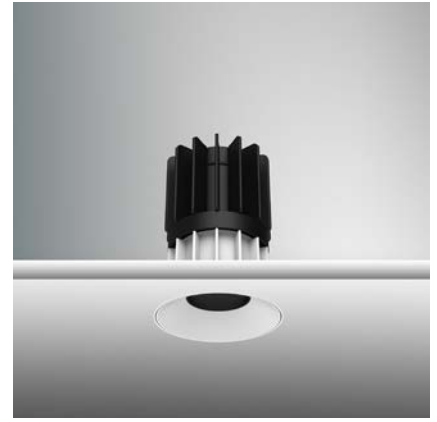

Article number	2318.206F-LEA-14	
	NON-IC	IC
Fixture Consumption	20W	15W
Current	450 (mA)	350 (mA)
Delivered Lumen	1231 (lm)	1027 (lm)
HE Delivered Lumen*	1538 (lm)	1283 (lm)
Beam Angle	25°/30°/45°/55° (Lens)	
CCT	3000K	
CRI	90+	
Driver Model	PUP20A-1WMC	
Article number	2318.206F-LEA-14-DW	
Fixture Consumption	15W	
Current	350 (mA)	
Delivered Lumen	909 (lm)	
Beam Angle	25°/30°/45°/55° (Lens)	
CCT	1800-3000K	
CRI	90+	
Driver Model	PUP20A-1WMC	

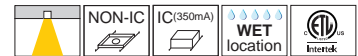

Dimmable

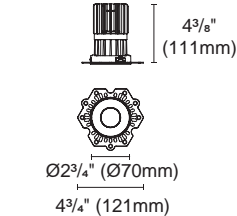

Cut out : 3 5/32" (80mm)

Accessories



ACHO-5 Honeycomb louver

ACOT-108 Suction cup

EP85-TL-WD Millwork

BRANKO-A-85C-RTA



Article number	2318.163-LEA-14	
	NON-IC	IC
Fixture Consumption	20W	15W
Current	450 (mA)	350 (mA)
Delivered Lumen	1222 (lm)	1020 (lm)
HE Delivered Lumen*	1527 (lm)	1275 (lm)
Beam Angle	25°/30°/45°/55° (Lens)	
CCT	3000K	
CRI	90+	
Driver Model	PUP20A-1WMC	
Article number	2318.163-LEA-14-DW	
Fixture Consumption	15W	
Current	350 (mA)	
Delivered Lumen	903 (lm)	
Beam Angle	25°/30°/45°/55° (Lens)	
CCT	1800-3000K	
CRI	90+	
Driver Model	PUP20A-1WMC	

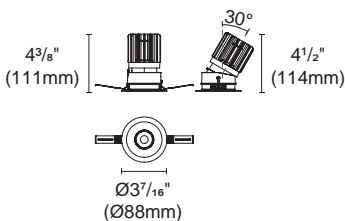

Dimmable

 Cut out : 3⁵/₃₂" (80mm)

Accessories

ACHO-5
Honeycomb louverS-007
Snoot

BRANKO-B-85C-RTA



Article number	2318.111-LEA-14	
	NON-IC	IC
Fixture Consumption	20W	15W
Current	450 (mA)	350 (mA)
Delivered Lumen	1222 (lm)	1020 (lm)
HE Delivered Lumen*	1527 (lm)	1275 (lm)
Beam Angle	25°/30°/45°/55° (Lens)	
CCT	3000K	
CRI	90+	
Driver Model	PUP20A-1WMC	
Article number	2318.111-LEA-14-DW	
Fixture Consumption	15W	
Current	350 (mA)	
Delivered Lumen	903 (lm)	
Beam Angle	25°/30°/45°/55° (Lens)	
CCT	1800-3000K	
CRI	90+	
Driver Model	PUP20A-1WMC	

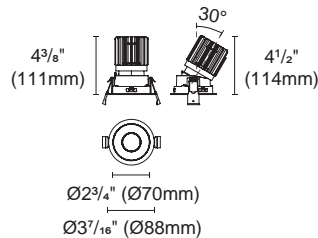

Dimmable

 Cut out : 3⁵/₃₂" (80mm)

Accessories

ACHO-5
Honeycomb louverS-007
Snoot

BRANKO-B-85C-RTL



Article number	2318.207F-LEA-14	
	NON-IC	IC
Fixture Consumption	20W	15W
Current	450 (mA)	350 (mA)
Delivered Lumen	1222 (lm)	1020 (lm)
HE Delivered Lumen*	1527 (lm)	1275 (lm)
Beam Angle	25°/30°/45°/55° (Lens)	
CCT	3000K	
CRI	90+	
Driver Model	PUP20A-1WMC	
Article number	2318.207F-LEA-14-DW	
Fixture Consumption	15W	
Current	350 (mA)	
Delivered Lumen	903 (lm)	
Beam Angle	25°/30°/45°/55° (Lens)	
CCT	1800-3000K	
CRI	90+	
Driver Model	PUP20A-1WMC	

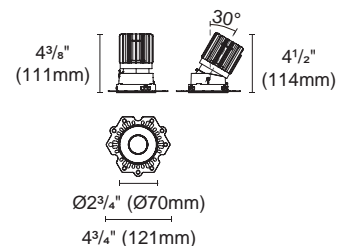

Dimmable

 Cut out : 3⁵/₃₂" (80mm)

Accessories

ACHO-5
Honeycomb louverS-007
SnootEP85-TL-WD
Millwork

BRANKO-A-85P-RTF



Article number	2318.162-LEA-14	
	NON-IC	IC
Fixture Consumption	20W	15W
Current	450 (mA)	350 (mA)
Delivered Lumen	1222 (lm)	977 (lm)
HE Delivered Lumen*	1527 (lm)	1221 (lm)
Beam Angle	25°/30°/45°/55° (Lens)	
CCT	3000K	
CRI	90+	
Driver Model	PUP20A-1WMC	
Article number	2318.162-LEA-14-DW	
Fixture Consumption	15W	
Current	350 (mA)	
Delivered Lumen	675 (lm)	
Beam Angle	25°/30°/45°/55° (Lens)	
CCT	1800-3000K	
CRI	90+	
Driver Model	PUP20A-1WMC	

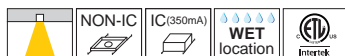

Dimmable

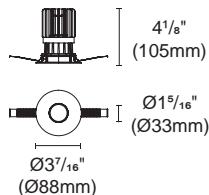

Cut out : 3⁷/₁₆" (80mm)

Accessories

ACHO-5
Honeycomb louver

BRANKO-B-85P-RTF



Article number	2318.114-LEA-14	
	NON-IC	IC
Fixture Consumption	20W	15W
Current	450 (mA)	350 (mA)
Delivered Lumen	1222 (lm)	977 (lm)
HE Delivered Lumen*	1527 (lm)	1221 (lm)
Beam Angle	25°/30°/45°/55° (Lens)	
CCT	3000K	
CRI	90+	
Driver Model	PUP20A-1WMC	
Article number	2318.114-LEA-14-DW	
Fixture Consumption	15W	
Current	350 (mA)	
Delivered Lumen	675 (lm)	
Beam Angle	25°/30°/45°/55° (Lens)	
CCT	1800-3000K	
CRI	90+	
Driver Model	PUP20A-1WMC	

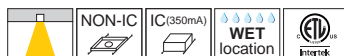

Dimmable

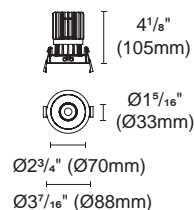

Cut out : 3⁷/₁₆" (80mm)

Accessories

ACHO-5
Honeycomb louver

BRANKO-B-85P-RTLF



Article number	2318.208F-LEA-14	
	NON-IC	IC
Fixture Consumption	20W	15W
Current	450 (mA)	350 (mA)
Delivered Lumen	1222 (lm)	977 (lm)
HE Delivered Lumen*	1527 (lm)	1221 (lm)
Beam Angle	25°/30°/45°/55° (Lens)	
CCT	3000K	
CRI	90+	
Driver Model	PUP20A-1WMC	
Article number	2318.208F-LEA-14-DW	
Fixture Consumption	15W	
Current	350 (mA)	
Delivered Lumen	675 (lm)	
Beam Angle	25°/30°/45°/55° (Lens)	
CCT	1800-3000K	
CRI	90+	
Driver Model	PUP20A-1WMC	

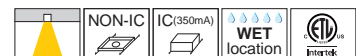

Dimmable

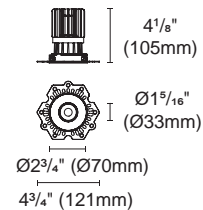

Cut out : 3⁷/₁₆" (80mm)

Accessories

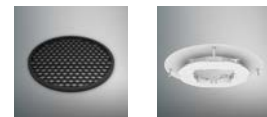
ACHO-5
Honeycomb louver
EP85-TL-WD
Millwork

BRANKO-A-85P-RTA



Article number	2318.164-LEA-14	
	NON-IC	IC
Fixture Consumption	20W	15W
Current	450 (mA)	350 (mA)
Delivered Lumen	1213 (lm)	966 (lm)
HE Delivered Lumen*	1516 (lm)	1207 (lm)
Beam Angle	25°/30°/45°/55° (Lens)	
CCT	3000K	
CRI	90+	
Driver Model	PUP20A-1WMC	
Article number	2318.164-LEA-14-DW	
Fixture Consumption	15W	
Current	350 (mA)	
Delivered Lumen	864- (lm)	
Beam Angle	25°/30°/45°/55° (Lens)	
CCT	1800-3000K	
CRI	90+	
Driver Model	PUP20A-1WMC	

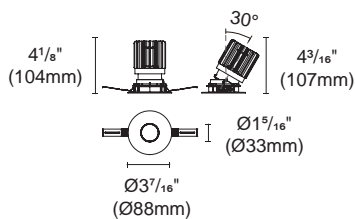

Dimmable

 Cut out : 3⁵/₃₂" (80mm)

Accessories

ACHO-5
Honeycomb louverS-007
Snoot

BRANKO-B-85P-RTA



Article number	2318.115-LEA-14	
	NON-IC	IC
Fixture Consumption	20W	15W
Current	450 (mA)	350 (mA)
Delivered Lumen	1213 (lm)	966 (lm)
HE Delivered Lumen*	1516 (lm)	1207 (lm)
Beam Angle	25°/30°/45°/55° (Lens)	
CCT	3000K	
CRI	90+	
Driver Model	PUP20A-1WMC	
Article number	2318.115-LEA-14-DW	
Fixture Consumption	15W	
Current	350 (mA)	
Delivered Lumen	864 (lm)	
Beam Angle	25°/30°/45°/55° (Lens)	
CCT	1800-3000K	
CRI	90+	
Driver Model	PUP20A-1WMC	

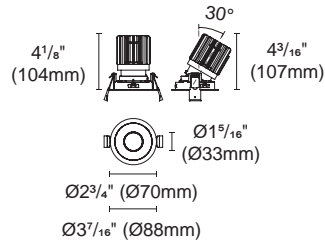

Dimmable

 Cut out : 3⁵/₃₂" (80mm)

Accessories

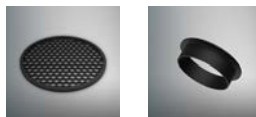
ACHO-5
Honeycomb louverS-007
Snoot

BRANKO-B-85P-RTLA



Article number	2318.209F-LEA-14	
	NON-IC	IC
Fixture Consumption	20W	15W
Current	450 (mA)	350 (mA)
Delivered Lumen	1213 (lm)	966 (lm)
HE Delivered Lumen*	1516 (lm)	1207 (lm)
Beam Angle	25°/30°/45°/55° (Lens)	
CCT	3000K	
CRI	90+	
Driver Model	PUP20A-1WMC	
Article number	2318.209F-LEA-14-DW	
Fixture Consumption	15W	
Current	350 (mA)	
Delivered Lumen	864 (lm)	
Beam Angle	25°/30°/45°/55° (Lens)	
CCT	1800-3000K	
CRI	90+	
Driver Model	PUP20A-1WMC	

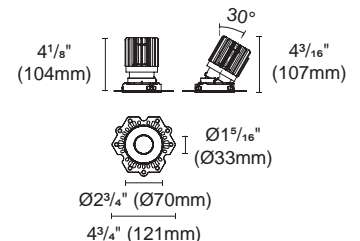

Dimmable

 Cut out : 3⁵/₃₂" (80mm)

Accessories

ACHO-5
Honeycomb louverS-007
SnootEP85-TL-WD
Millwork

BRANKO-A-85C-STF



Article number	2418.103-LEA-14	
	NON-IC	IC
Fixture Consumption	20W	15W
Current	450 (mA)	350 (mA)
Delivered Lumen	1181 (lm)	950 (lm)
HE Delivered Lumen*	1476 (lm)	1187 (lm)
Beam Angle	25°/30°/45°/55° (Lens)	
CCT	3000K	
CRI	90+	
Driver Model	PUP20A-1WMC	
Article number	2418.103-LEA-14-DW	
Fixture Consumption	15W	
Current	350 (mA)	
Delivered Lumen	841 (lm)	
Beam Angle	25°/30°/45°/55° (Lens)	
CCT	1800-3000K	
CRI	90+	
Driver Model	PUP20A-1WMC	

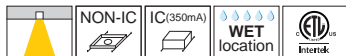

Dimmable

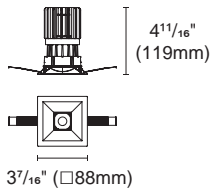

Cut out : 3⁵/₃₂"X3⁵/₃₂" (80X80mm)

Accessories



ACHO-5
Honeycomb louver

BRANKO-B-85C-STF



Article number	2418.109-LEA-14	
	NON-IC	IC
Fixture Consumption	20W	15W
Current	450 (mA)	350 (mA)
Delivered Lumen	1181 (lm)	950 (lm)
HE Delivered Lumen*	1476 (lm)	1187 (lm)
Beam Angle	25°/30°/45°/55° (Lens)	
CCT	3000K	
CRI	90+	
Driver Model	PUP20A-1WMC	
Article number	2418.109-LEA-14-DW	
Fixture Consumption	15W	
Current	350 (mA)	
Delivered Lumen	841 (lm)	
Beam Angle	25°/30°/45°/55° (Lens)	
CCT	1800-3000K	
CRI	90+	
Driver Model	PUP20A-1WMC	

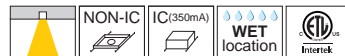

Dimmable

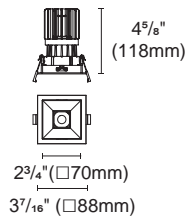

Cut out : 3⁵/₃₂"X3⁵/₃₂" (80X80mm)

Accessories



ACHO-5
Honeycomb louver

BRANKO-B-85C-STLF



Article number	2418.200A-LEA-14	
	NON-IC	IC
Fixture Consumption	20W	15W
Current	450 (mA)	350 (mA)
Delivered Lumen	1181 (lm)	950 (lm)
HE Delivered Lumen*	1476 (lm)	1187 (lm)
Beam Angle	25°/30°/45°/55° (Lens)	
CCT	3000K	
CRI	90+	
Driver Model	PUP20A-1WMC	
Article number	2418.200A-LEA-14-DW	
Fixture Consumption	15W	
Current	350 (mA)	
Delivered Lumen	841 (lm)	
Beam Angle	25°/30°/45°/55° (Lens)	
CCT	1800-3000K	
CRI	90+	
Driver Model	PUP20A-1WMC	

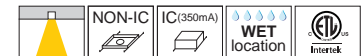

Dimmable

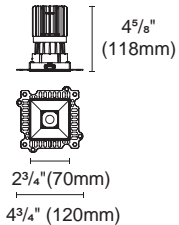

Cut out : 3⁵/₃₂"X3⁵/₃₂" (80X80mm)

Accessories

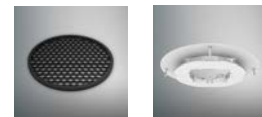

ACHO-5
Honeycomb louver EP85-TL-WD
Millwork

BRANKO-A-85C-STA



Article number	2418.107-LEA-14	
	NON-IC	IC
Fixture Consumption	20W	15W
Current	450 (mA)	350 (mA)
Delivered Lumen	1177 (lm)	948 (lm)
HE Delivered Lumen*	1471 (lm)	1185 (lm)
Beam Angle	25°/30°/45°/55° (Lens)	
CCT	3000K	
CRI	90+	
Driver Model	PUP20A-1WMC	
Article number	2418.107-LEA-14-DW	
Fixture Consumption	15W	
Current	350 (mA)	
Delivered Lumen	839 (lm)	
Beam Angle	25°/30°/45°/55° (Lens)	
CCT	1800-3000K	
CRI	90+	
Driver Model	PUP20A-1WMC	



BRANKO-B-85C-STA



Article number	2418.111-LEA-14	
	NON-IC	IC
Fixture Consumption	20W	15W
Current	450 (mA)	350 (mA)
Delivered Lumen	1177 (lm)	948 (lm)
HE Delivered Lumen*	1471 (lm)	1185 (lm)
Beam Angle	25°/30°/45°/55° (Lens)	
CCT	3000K	
CRI	90+	
Driver Model	PUP20A-1WMC	
Article number	2418.111-LEA-14-DW	
Fixture Consumption	15W	
Current	350 (mA)	
Delivered Lumen	839 (lm)	
Beam Angle	25°/30°/45°/55° (Lens)	
CCT	1800-3000K	
CRI	90+	
Driver Model	PUP20A-1WMC	



Dimmable

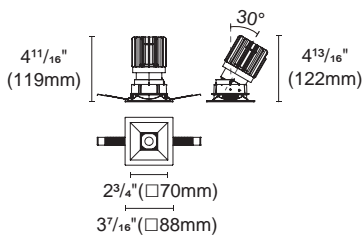

Cut out : 3⁵/₃₂"X3⁵/₃₂" (80X80mm)

Accessories

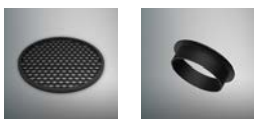
ACHO-5
Honeycomb louverS-007
Snoot

BRANKO-B-85C-STLA



Article number	2418.202A-LEA-14	
	NON-IC	IC
Fixture Consumption	20W	15W
Current	450 (mA)	350 (mA)
Delivered Lumen	1177 (lm)	948 (lm)
HE Delivered Lumen*	1471 (lm)	1185 (lm)
Beam Angle	25°/30°/45°/55° (Lens)	
CCT	3000K	
CRI	90+	
Driver Model	PUP20A-1WMC	
Article number	2418.202A-LEA-14-DW	
Fixture Consumption	15W	
Current	350 (mA)	
Delivered Lumen	839 (lm)	
Beam Angle	25°/30°/45°/55° (Lens)	
CCT	1800-3000K	
CRI	90+	
Driver Model	PUP20A-1WMC	



Dimmable

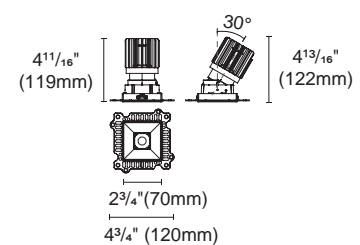

Cut out : 3⁵/₃₂"X3⁵/₃₂" (80X80mm)

Accessories

ACHO-5
Honeycomb louverS-007
SnootEP85-TL-WD
Millwork

BRANKO-A-85P-STF



Article number	2418.104-LEA-14	
	NON-IC	IC
Fixture Consumption	20W	15W
Current	450 (mA)	350 (mA)
Delivered Lumen	1173 (lm)	945 (lm)
HE Delivered Lumen*	1466 (lm)	1181 (lm)
Beam Angle	25°/30°/45°/55° (Lens)	
CCT	3000K	
CRI	90+	
Driver Model	PUP20A-1WMC	
Article number	2418.104-LEA-14-DW	
Fixture Consumption	15W	
Current	350 (mA)	
Delivered Lumen	640 (lm)	
Beam Angle	20°/25°/35°/45° (Lens)	
CCT	1800-3000K	
CRI	90+	
Driver Model	PUP20A-1WMC	

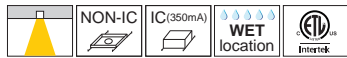

Dimmable

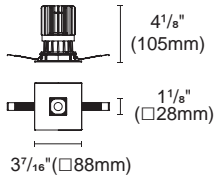

△ Cut out : 3⁵/₁₆"X3⁵/₁₆" (80X80mm)

Accessories



ACHO-5
Honeycomb louver

BRANKO-B-85P-STF



Article number	2418.110-LEA-14	
	NON-IC	IC
Fixture Consumption	20W	15W
Current	450 (mA)	350 (mA)
Delivered Lumen	1173 (lm)	945 (lm)
HE Delivered Lumen*	1466 (lm)	1181 (lm)
Beam Angle	25°/30°/45°/55° (Lens)	
CCT	3000K	
CRI	90+	
Driver Model	PUP20A-1WMC	
Article number	2418.110-LEA-14-DW	
Fixture Consumption	15W	
Current	350 (mA)	
Delivered Lumen	640 (lm)	
Beam Angle	20°/25°/35°/45° (Lens)	
CCT	1800-3000K	
CRI	90+	
Driver Model	PUP20A-1WMC	

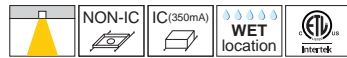

Dimmable

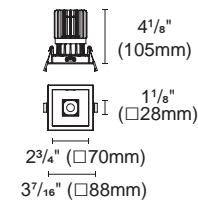

△ Cut out : 3⁵/₁₆"X3⁵/₁₆" (80X80mm)

Accessories



ACHO-5
Honeycomb louver

BRANKO-B-85P-STLF



Article number	2418.201A-LEA-14	
	NON-IC	IC
Fixture Consumption	20W	15W
Current	450 (mA)	350 (mA)
Delivered Lumen	1173 (lm)	945 (lm)
HE Delivered Lumen*	1466 (lm)	1181 (lm)
Beam Angle	25°/30°/45°/55° (Lens)	
CCT	3000K	
CRI	90+	
Driver Model	PUP20A-1WMC	
Article number	2418.201A-LEA-14-DW	
Fixture Consumption	15W	
Current	350 (mA)	
Delivered Lumen	640 (lm)	
Beam Angle	20°/25°/35°/45° (Lens)	
CCT	1800-3000K	
CRI	90+	
Driver Model	PUP20A-1WMC	

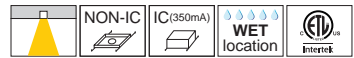

Dimmable

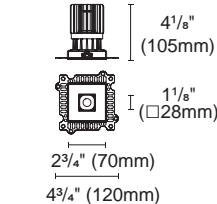

△ Cut out : 3⁵/₁₆"X3⁵/₁₆" (80X80mm)

Accessories

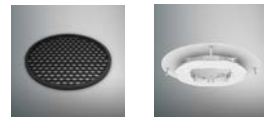

ACHO-5
Honeycomb louver EP85-TL-WD
Millwork

BRANKO-A-85P-STA



Article number	2418.108-LEA-14	
	NON-IC	IC
Fixture Consumption	20W	15W
Current	450 (mA)	350 (mA)
Delivered Lumen	1170 (lm)	932 (lm)
HE Delivered Lumen*	1462 (lm)	1165 (lm)
Beam Angle	25°/30°/45°/55° (Lens)	
CCT	3000K	
CRI	90+	
Driver Model	PUP20A-1WMC	
Article number	2418.108-LEA-14-DW	
Fixture Consumption	15W	
Current	350 (mA)	
Delivered Lumen	833 (lm)	
Beam Angle	25°/30°/45°/55° (Lens)	
CCT	1800-3000K	
CRI	90+	
Driver Model	PUP20A-1WMC	

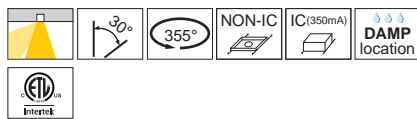

Dimmable

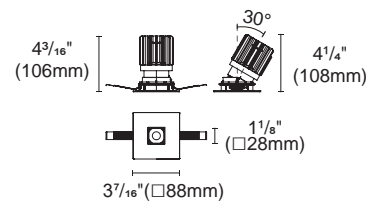
 Cut out : 3⁵/₃₂"X3⁵/₃₂" (80X80mm)

Accessories

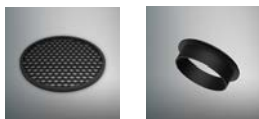
ACHO-5
Honeycomb louverS-007
Snoot

BRANKO-B-85P-STA



Article number	2418.112-LEA-14	
	NON-IC	IC
Fixture Consumption	20W	15W
Current	450 (mA)	350 (mA)
Delivered Lumen	1170 (lm)	932 (lm)
HE Delivered Lumen*	1462 (lm)	1165 (lm)
Beam Angle	25°/30°/45°/55° (Lens)	
CCT	3000K	
CRI	90+	
Driver Model	PUP20A-1WMC	
Article number	2418.112-LEA-14-DW	
Fixture Consumption	15W	
Current	350 (mA)	
Delivered Lumen	833 (lm)	
Beam Angle	25°/30°/45°/55° (Lens)	
CCT	1800-3000K	
CRI	90+	
Driver Model	PUP20A-1WMC	

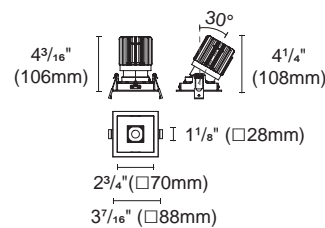

Dimmable

 Cut out : 3⁵/₃₂"X3⁵/₃₂" (80X80mm)

Accessories

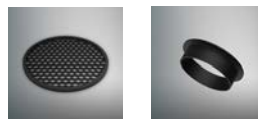
ACHO-5
Honeycomb louverS-007
Snoot

BRANKO-B-85P-STLA



Article number	2418.203A-LEA-14	
	NON-IC	IC
Fixture Consumption	20W	15W
Current	450 (mA)	350 (mA)
Delivered Lumen	1170 (lm)	932 (lm)
HE Delivered Lumen*	1462 (lm)	1165 (lm)
Beam Angle	25°/30°/45°/55° (Lens)	
CCT	3000K	
CRI	90+	
Driver Model	PUP20A-1WMC	
Article number	2418.203A-LEA-14-DW	
Fixture Consumption	15W	
Current	350 (mA)	
Delivered Lumen	833 (lm)	
Beam Angle	25°/30°/45°/55° (Lens)	
CCT	1800-3000K	
CRI	90+	
Driver Model	PUP20A-1WMC	

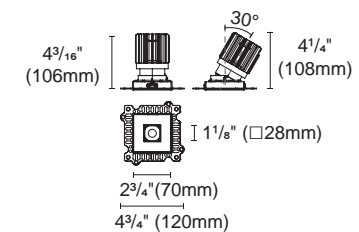

Dimmable

 Cut out : 3⁵/₃₂"X3⁵/₃₂" (80X80mm)

Accessories

ACHO-5
Honeycomb louverS-007
SnootEP85-TL-WD
Millwork



BRANKO-110

3.5"

Round / Square

Fixed
Adjustable

BRANKO-A-110C-RTF



Article number	2318.131-LEA-15
Fixture Consumption	21W
Current	500 (mA)
Delivered Lumen	1559 (lm)
HE Delivered Lumen*	1948 (lm)
Beam Angle	20°/30°/45°/55° (Lens)
CCT	3000K
CRI	90+
Driver Model	PUP20A-1WMC

Article number	2318.131-LEA-15-DW
Fixture Consumption	18W
Current	450 (mA)
Delivered Lumen	34-1003 (lm)
Beam Angle	20°/25°/40°/45° (Lens)
CCT	1800-3000K
CRI	90+
Driver Model	PUP20A-1WMC



Dimmable

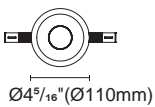

⊕ Cut out : 3³⁰/₃₂" (100mm)

Accessories



H7-1
Honeycomb louver

BRANKO-B-110C-RTF



Article number	2318.133-LEA-15
Fixture Consumption	21W
Current	500 (mA)
Delivered Lumen	1559 (lm)
HE Delivered Lumen*	1948 (lm)
Beam Angle	20°/30°/45°/55° (Lens)
CCT	3000K
CRI	90+
Driver Model	PUP20A-1WMC

Article number	2318.133-LEA-15-DW
Fixture Consumption	18W
Current	450 (mA)
Delivered Lumen	34-1003 (lm)
Beam Angle	20°/25°/40°/45° (Lens)
CCT	1800-3000K
CRI	90+
Driver Model	PUP20A-1WMC



Dimmable

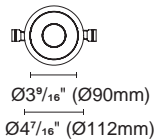

⊕ Cut out : 3³⁰/₃₂" (100mm)

Accessories



H7-1
Honeycomb louver

BRANKO-B-110C-RTLF

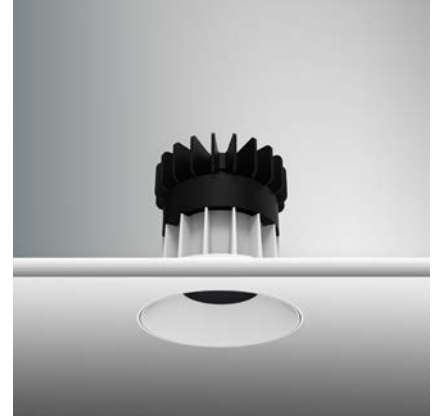

Article number	2318.214F-LEA-15
Fixture Consumption	21W
Current	500 (mA)
Delivered Lumen	1559 (lm)
HE Delivered Lumen*	1948 (lm)
Beam Angle	20°/30°/45°/55° (Lens)
CCT	3000K
CRI	90+
Driver Model	PUP20A-1WMC

Article number	2318.214F-LEA-15-DW
Fixture Consumption	18W
Current	450 (mA)
Delivered Lumen	34-1003 (lm)
Beam Angle	20°/25°/40°/45° (Lens)
CCT	1800-3000K
CRI	90+
Driver Model	PUP20A-1WMC



Dimmable

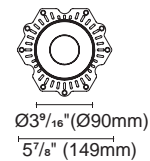
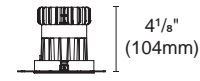

⊕ Cut out : 3³⁰/₃₂" (100mm)

Accessories



H7-1
Honeycomb louver

ACOT-109
Suction cup

EP110-TL-WD
Millwork

BRANKO-A-110C-RTA



Article number	2318.135-LEA-15
Fixture Consumption	21W
Current	500 (mA)
Delivered Lumen	1528 (lm)
HE Delivered Lumen*	1910 (lm)
Beam Angle	20°/30°/45°/55° (Lens)
CCT	3000K
CRI	90+
Driver Model	PUP20A-1WMC

Article number	2318.135-LEA-15-DW
Fixture Consumption	18W
Current	450 (mA)
Delivered Lumen	34-977 (lm)
Beam Angle	20°/25°/40°/45° (Lens)
CCT	1800-3000K
CRI	90+
Driver Model	PUP20A-1WMC

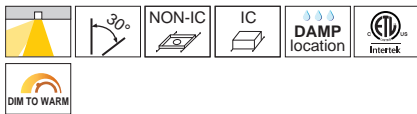

Dimmable

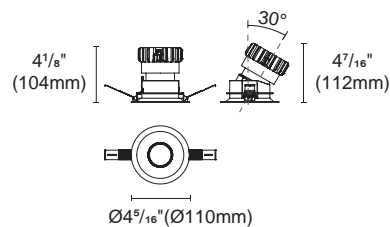

⊘ Cut out : 3³⁰/₃₂" (100mm)

Accessories

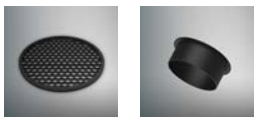
H7-1
Honeycomb louverACSN-17
Snoot

BRANKO-B-110C-RTA



Article number	2318.137-LEA-15
Fixture Consumption	21W
Current	500 (mA)
Delivered Lumen	1528 (lm)
HE Delivered Lumen*	1910 (lm)
Beam Angle	20°/30°/45°/55° (Lens)
CCT	3000K
CRI	90+
Driver Model	PUP20A-1WMC

Article number	2318.137-LEA-15-DW
Fixture Consumption	18W
Current	450 (mA)
Delivered Lumen	34-977 (lm)
Beam Angle	20°/25°/40°/45° (Lens)
CCT	1800-3000K
CRI	90+
Driver Model	PUP20A-1WMC

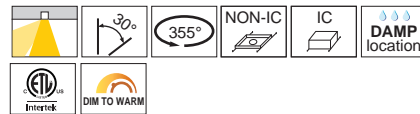

Dimmable

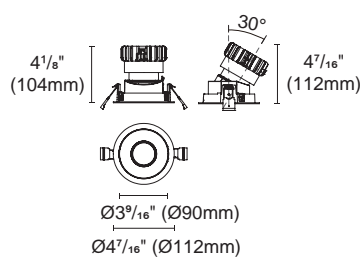

⊘ Cut out : 3³⁰/₃₂" (100mm)

Accessories

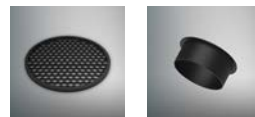
H7-1
Honeycomb louverACSN-17
Snoot

BRANKO-B-110C-RTLA



Article number	2318.216F-LEA-15
Fixture Consumption	21W
Current	500 (mA)
Delivered Lumen	1528 (lm)
HE Delivered Lumen*	1910 (lm)
Beam Angle	20°/30°/45°/55° (Lens)
CCT	3000K
CRI	90+
Driver Model	PUP20A-1WMC

Article number	2318.216F-LEA-15-DW
Fixture Consumption	18W
Current	450 (mA)
Delivered Lumen	34-977 (lm)
Beam Angle	20°/25°/40°/45° (Lens)
CCT	1800-3000K
CRI	90+
Driver Model	PUP20A-1WMC



Dimmable

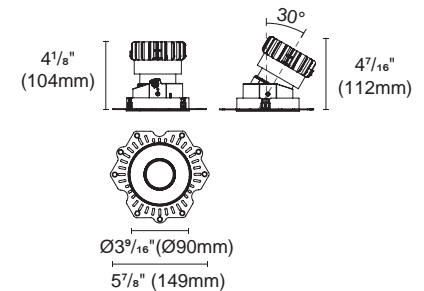

⊘ Cut out : 3³⁰/₃₂" (100mm)

Accessories

H7-1
Honeycomb louverACSN-17
SnootEP110-TL-WD
Millwork

BRANKO-A-110P-RTF



Article number	2318.166-LEA-15
Fixture Consumption	21W
Current	500 (mA)
Delivered Lumen	1487 (lm)
HE Delivered Lumen*	1858 (lm)
Beam Angle	20°/30°/45°/55° (Lens)
CCT	3000K
CRI	90+
Driver Model	PUP20A-1WMC

Article number	2318.166-LEA-15-DW
Fixture Consumption	18W
Current	450 (mA)
Lumen	34-1507 (lm)
Beam Angle	15°/24°/36°/50° (Lens)
CCT	1800-3000K
CRI	90+
Driver Model	PUP20A-1WMC



Dimmable

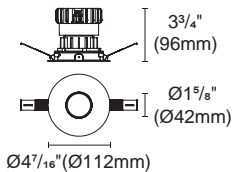

⊘ Cut out : 3³⁰/₃₂" (100mm)

Accessories

H7-1
Honeycomb louver

BRANKO-B-110P-RTF



Article number	2318.134-LEA-15
Fixture Consumption	21W
Current	500 (mA)
Delivered Lumen	1487 (lm)
HE Delivered Lumen*	1858 (lm)
Beam Angle	20°/30°/45°/55° (Lens)
CCT	3000K
CRI	90+
Driver Model	PUP20A-1WMC

Article number	2318.134-LEA-15-DW
Fixture Consumption	18W
Current	450 (mA)
Lumen	34-1507 (lm)
Beam Angle	15°/24°/36°/50° (Lens)
CCT	1800-3000K
CRI	90+
Driver Model	PUP20A-1WMC



Dimmable

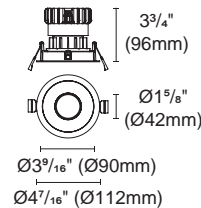

⊘ Cut out : 3³⁰/₃₂" (100mm)

Accessories

H7-1
Honeycomb louver

BRANKO-B-110P-RTL



Article number	2318.215F-LEA-15
Fixture Consumption	21W
Current	500 (mA)
Delivered Lumen	1487 (lm)
HE Delivered Lumen*	1858 (lm)
Beam Angle	20°/30°/45°/55° (Lens)
CCT	3000K
CRI	90+
Driver Model	PUP20A-1WMC

Article number	2318.215F-LEA-15-DW
Fixture Consumption	18W
Current	450 (mA)
Lumen	34-1507 (lm)
Beam Angle	15°/24°/36°/50° (Lens)
CCT	1800-3000K
CRI	90+
Driver Model	PUP20A-1WMC



Dimmable

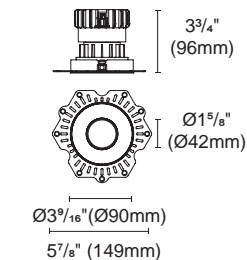

⊘ Cut out : 3³⁰/₃₂" (100mm)

Accessories

H7-1
Honeycomb louver
EP110-TL-WD
Millwork

BRANKO-A-110P-RTA



Article number	2318.136-LEA-15
Fixture Consumption	21W
Current	500 (mA)
Delivered Lumen	1463 (lm)
HE Delivered Lumen*	1828 (lm)
Beam Angle	20°/30°/40°/50° (Lens)
CCT	3000K
CRI	90+
Driver Model	PUP20A-1WMC

Article number	2318.136-LEA-15-DW
Fixture Consumption	18W
Current	450 (mA)
Delivered Lumen	34-876(lm)
Beam Angle	20°/24°/38°/42° (Lens)
CCT	1800-3000K
CRI	90+
Driver Model	PUP20A-1WMC

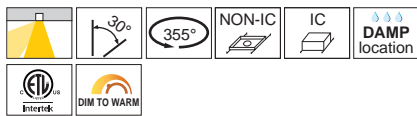

Dimmable

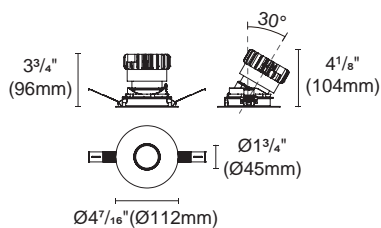
Cut out : 3³⁰/₃₂" (100mm)

Accessories

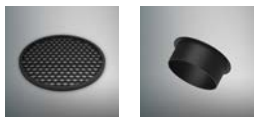

H7-1 Honeycomb louver ACSN-17 Snoot

BRANKO-B-110P-RTA



Article number	2318.138-LEA-15
Fixture Consumption	21W
Current	500 (mA)
Delivered Lumen	1463 (lm)
HE Delivered Lumen*	1828 (lm)
Beam Angle	20°/30°/40°/50° (Lens)
CCT	3000K
CRI	90+
Driver Model	PUP20A-1WMC

Article number	2318.138-LEA-15-DW
Fixture Consumption	18W
Current	450 (mA)
Delivered Lumen	34-876(lm)
Beam Angle	20°/24°/38°/42° (Lens)
CCT	1800-3000K
CRI	90+
Driver Model	PUP20A-1WMC

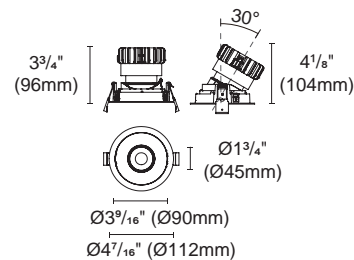

Dimmable

Cut out : 3³⁰/₃₂" (100mm)

Accessories

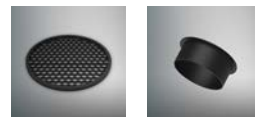

H7-1 Honeycomb louver ACSN-17 Snoot

BRANKO-B-110P-RTLA



Article number	2318.217F-LEA-15
Fixture Consumption	21W
Current	500 (mA)
Delivered Lumen	1463 (lm)
HE Delivered Lumen*	1828 (lm)
Beam Angle	20°/30°/40°/50° (Lens)
CCT	3000K
CRI	90+
Driver Model	PUP20A-1WMC

Article number	2318.217F-LEA-15-DW
Fixture Consumption	18W
Current	450 (mA)
Delivered Lumen	34-876(lm)
Beam Angle	20°/24°/38°/42° (Lens)
CCT	1800-3000K
CRI	90+
Driver Model	PUP20A-1WMC

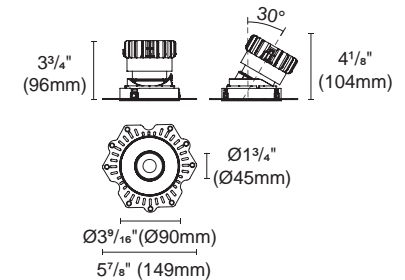

Dimmable

Cut out : 3³⁰/₃₂" (100mm)

Accessories



H7-1 Honeycomb louver ACSN-17 Snoot EP110-TL-WD Millwork

BRANKO-A-110C-STF



Article number	2418.119-LEA-15
Fixture Consumption	21W
Current	500 (mA)
Delivered Lumen	1486 (lm)
HE Delivered Lumen*	1857 (lm)
Beam Angle	20°/30°/45°/55° (Lens)
CCT	3000K
CRI	90+
Driver Model	PUP20A-1WMC

Article number	2418.119-LEA-15-DW
Fixture Consumption	18W
Current	450 (mA)
Lumen	34-1507 (lm)
Beam Angle	15°/24°/36°/50° (Lens)
CCT	1800-3000K
CRI	90+
Driver Model	PUP20A-1WMC



Dimmable

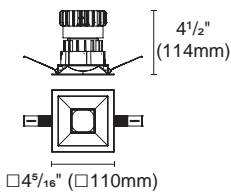

Cut out : 3³⁰/₃₂"X3³⁰/₃₂" (100X100mm)

Accessories

H7-1
Honeycomb louver

BRANKO-B-110C-STF



Article number	2418.113-LEA-15
Fixture Consumption	21W
Current	500 (mA)
Delivered Lumen	1486 (lm)
HE Delivered Lumen*	1857 (lm)
Beam Angle	20°/30°/45°/55° (Lens)
CCT	3000K
CRI	90+
Driver Model	PUP20A-1WMC

Article number	2418.113-LEA-15-DW
Fixture Consumption	18W
Current	450 (mA)
Lumen	34-1507 (lm)
Beam Angle	15°/24°/36°/50° (Lens)
CCT	1800-3000K
CRI	90+
Driver Model	PUP20A-1WMC



Dimmable

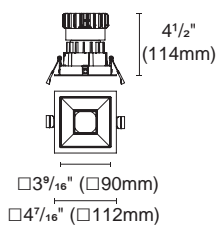

Cut out : 3³⁰/₃₂"X3³⁰/₃₂" (100X100mm)

Accessories

H7-1
Honeycomb louver

BRANKO-B-110C-STLF



Article number	2418.204A-LEA-15
Fixture Consumption	21W
Current	500 (mA)
Delivered Lumen	1486 (lm)
HE Delivered Lumen*	1857 (lm)
Beam Angle	20°/30°/45°/55° (Lens)
CCT	3000K
CRI	90+
Driver Model	PUP20A-1WMC

Article number	2418.204A-LEA-15-DW
Fixture Consumption	18W
Current	450 (mA)
Lumen	34-1507 (lm)
Beam Angle	15°/24°/36°/50° (Lens)
CCT	1800-3000K
CRI	90+
Driver Model	PUP20A-1WMC



Dimmable

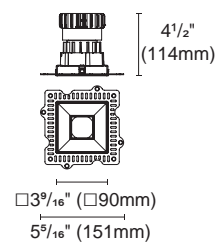

Cut out : 3³⁰/₃₂"X3³⁰/₃₂" (100X100mm)

Accessories

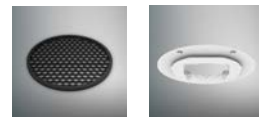
H7-1
Honeycomb louver EP110-TL-WD
Millwork

BRANKO-A-110C-STA



Article number	2418.121-LEA-15
Fixture Consumption	21W
Current	500 (mA)
Delivered Lumen	1485 (lm)
HE Delivered Lumen*	1856 (lm)
Beam Angle	20°/30°/45°/55° (Lens)
CCT	3000K
CRI	90+
Driver Model	PUP20A-1WMC

Article number	2418.121-LEA-15-DW
Fixture Consumption	18W
Current	450 (mA)
Lumen	34-1507 (lm)
Beam Angle	15°/24°/36°/50° (Lens)
CCT	1800-3000K
CRI	90+
Driver Model	PUP20A-1WMC



Dimmable

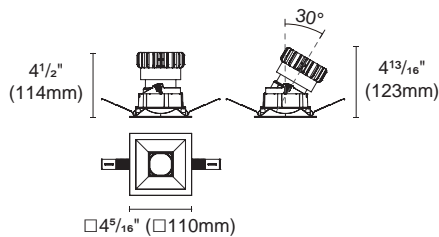

Cut out : 3³⁰/₃₂"X3³⁰/₃₂" (100X100mm)

Accessories

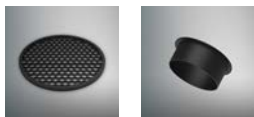

H7-1 Honeycomb louver
ACSN-17 Snoot

BRANKO-B-110C-STA



Article number	2418.115-LEA-15
Fixture Consumption	21W
Current	500 (mA)
Delivered Lumen	1485 (lm)
HE Delivered Lumen*	1856 (lm)
Beam Angle	20°/30°/45°/55° (Lens)
CCT	3000K
CRI	90+
Driver Model	PUP20A-1WMC

Article number	2418.115-LEA-15-DW
Fixture Consumption	18W
Current	450 (mA)
Lumen	34-1507 (lm)
Beam Angle	15°/24°/36°/50° (Lens)
CCT	1800-3000K
CRI	90+
Driver Model	PUP20A-1WMC



Dimmable

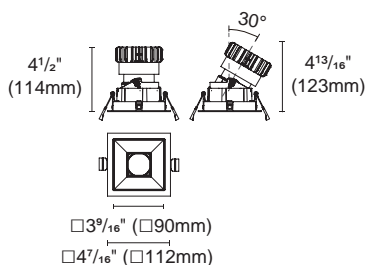

Cut out : 3³⁰/₃₂"X3³⁰/₃₂" (100X100mm)

Accessories

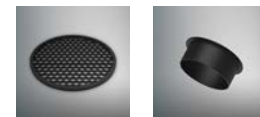

H7-1 Honeycomb louver
ACSN-17 Snoot

BRANKO-B-110C-STLA



Article number	2418.206A-LEA-15
Fixture Consumption	21W
Current	500 (mA)
Delivered Lumen	1485 (lm)
HE Delivered Lumen*	1856 (lm)
Beam Angle	20°/30°/45°/55° (Lens)
CCT	3000K
CRI	90+
Driver Model	PUP20A-1WMC

Article number	2418.206A-LEA-15-DW
Fixture Consumption	18W
Current	450 (mA)
Lumen	34-1507 (lm)
Beam Angle	15°/24°/36°/50° (Lens)
CCT	1800-3000K
CRI	90+
Driver Model	PUP20A-1WMC



Dimmable

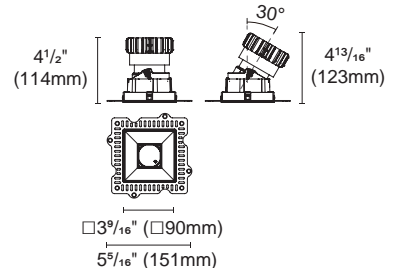

Cut out : 3³⁰/₃₂"X3³⁰/₃₂" (100X100mm)

Accessories



H7-1 Honeycomb louver
ACSN-17 Snoot
EP110-TL-WD Millwork

BRANKO-A-110P-STF



Article number	2418.120-LEA-15
Fixture Consumption	21W
Current	500 (mA)
Delivered Lumen	1489 (lm)
HE Delivered Lumen*	1861 (lm)
Beam Angle	20°/30°/40°/55° (Lens)
CCT	3000K
CRI	90+
Driver Model	PUP20A-1WMC

Article number	2418.120-LEA-15-DW
Fixture Consumption	18W
Current	450 (mA)
Lumen	34-1507 (lm)
Beam Angle	15°/24°/36°/50° (Lens)
CCT	1800-3000K
CRI	90+
Driver Model	PUP20A-1WMC



Dimmable

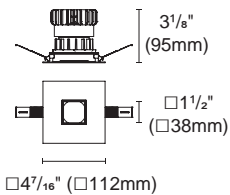

△ Cut out : 3³⁰/₃₂"X3³⁰/₃₂" (100X100mm)

Accessories



H7-1
Honeycomb louver

BRANKO-B-110P-STF



Article number	2418.114-LEA-15
Fixture Consumption	21W
Current	500 (mA)
Delivered Lumen	1489 (lm)
HE Delivered Lumen*	1861 (lm)
Beam Angle	20°/30°/40°/55° (Lens)
CCT	3000K
CRI	90+
Driver Model	PUP20A-1WMC

Article number	2418.114-LEA-15-DW
Fixture Consumption	18W
Current	450 (mA)
Lumen	34-1507 (lm)
Beam Angle	15°/24°/36°/50° (Lens)
CCT	1800-3000K
CRI	90+
Driver Model	PUP20A-1WMC



Dimmable

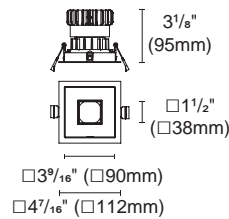

△ Cut out : 3³⁰/₃₂"X3³⁰/₃₂" (100X100mm)

Accessories



H7-1
Honeycomb louver

BRANKO-B-110P-STLF



Article number	2418.205A-LEA-15
Fixture Consumption	21W
Current	500 (mA)
Delivered Lumen	1489 (lm)
HE Delivered Lumen*	1861 (lm)
Beam Angle	20°/30°/40°/55° (Lens)
CCT	3000K
CRI	90+
Driver Model	PUP20A-1WMC

Article number	2418.205A-LEA-15-DW
Fixture Consumption	18W
Current	450 (mA)
Lumen	34-1507 (lm)
Beam Angle	15°/24°/36°/50° (Lens)
CCT	1800-3000K
CRI	90+
Driver Model	PUP20A-1WMC



Dimmable

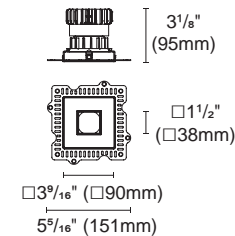

△ Cut out : 3³⁰/₃₂"X3³⁰/₃₂" (100X100mm)

Accessories

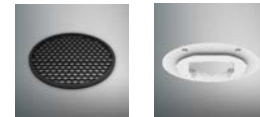

H7-1
Honeycomb louver
EP110-TL-WD
Millwork

BRANKO-A-110P-STA



Article number	2318.153-LEA-15
Fixture Consumption	21W
Current	500 (mA)
Delivered Lumen	1435 (lm)
HE Delivered Lumen*	1793 (lm)
Beam Angle	20°/30°/40°/50° (Lens)
CCT	3000K
CRI	90+
Driver Model	PUP20A-1WMC

Article number	2318.153-LEA-15-DW
Fixture Consumption	18W
Current	450 (mA)
Delivered Lumen	34-916 (lm)
Beam Angle	20°/25°/37°/41° (Lens)
CCT	1800-3000K
CRI	90+
Driver Model	PUP20A-1WMC

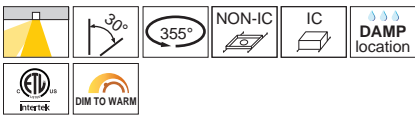

Dimmable

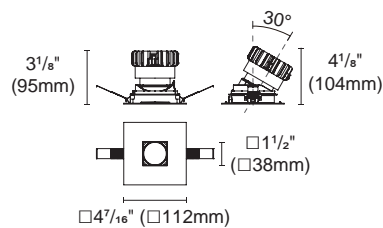
 Cut out : 3³⁰/₃₂"X3³⁰/₃₂" (100X100mm)

Accessories

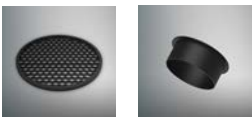

H7-1 Honeycomb louver
ACSN-17 Snoot

BRANKO-B-110P-STA



Article number	2318.154-LEA-15
Fixture Consumption	21W
Current	500 (mA)
Delivered Lumen	1435 (lm)
HE Delivered Lumen*	1793 (lm)
Beam Angle	20°/30°/40°/50° (Lens)
CCT	3000K
CRI	90+
Driver Model	PUP20A-1WMC

Article number	2318.154-LEA-15-DW
Fixture Consumption	18W
Current	450 (mA)
Delivered Lumen	34-916 (lm)
Beam Angle	20°/25°/37°/41° (Lens)
CCT	1800-3000K
CRI	90+
Driver Model	PUP20A-1WMC

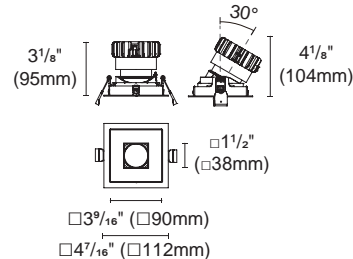

Dimmable

 Cut out : 3³⁰/₃₂"X3³⁰/₃₂" (100X100mm)

Accessories

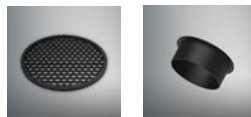

H7-1 Honeycomb louver
ACSN-17 Snoot

BRANKO-B-110P-STLA



Article number	2318.218A-LEA-15
Fixture Consumption	21W
Current	500 (mA)
Delivered Lumen	1435 (lm)
HE Delivered Lumen*	1793 (lm)
Beam Angle	20°/30°/40°/50° (Lens)
CCT	3000K
CRI	90+
Driver Model	PUP20A-1WMC

Article number	2318.218A-LEA-15-DW
Fixture Consumption	18W
Current	450 (mA)
Delivered Lumen	34-916 (lm)
Beam Angle	20°/25°/37°/41° (Lens)
CCT	1800-3000K
CRI	90+
Driver Model	PUP20A-1WMC

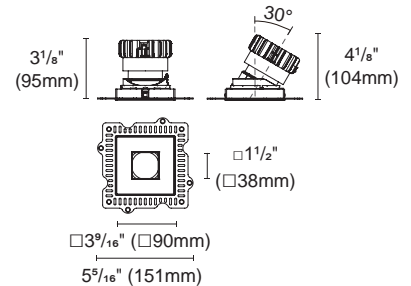

Dimmable

 Cut out : 3³⁰/₃₂"X3³⁰/₃₂" (100X100mm)

Accessories



H7-1 Honeycomb louver
ACSN-17 Snoot
EP110-TL-WD Millwork

BRANKO-A-110C-RTF



Article number	2318.131-ACOT-84-AM	
	NON-IC	IC
Fixture Consumption	30W	25W
Current	700 (mA)	600 (mA)
Delivered Lumen	1932 (lm)	1695 (lm)
HE Delivered Lumen*	2434 (lm)	2118 (lm)
Beam Angle	25°/35°/45°/55° (Lens)	
CCT	3000K	
CRI	90+	
Driver Model	PUP40A-1WMC-850	

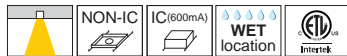

Dimmable

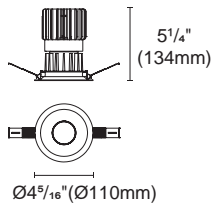

Ⓢ Cut out : 3³⁰/₃₂" (100mm)

Accessories

H7-1
Honeycomb louver

BRANKO-B-110C-RTF



Article number	2318.133-ACOT-84-AM	
	NON-IC	IC
Fixture Consumption	30W	25W
Current	700 (mA)	600 (mA)
Delivered Lumen	1932 (lm)	1695 (lm)
HE Delivered Lumen*	2434 (lm)	2118 (lm)
Beam Angle	25°/35°/45°/55° (Lens)	
CCT	3000K	
CRI	90+	
Driver Model	PUP40A-1WMC-850	

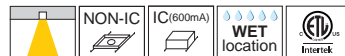

Dimmable

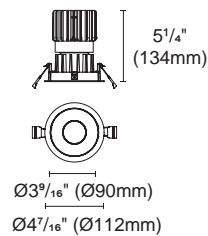

Ⓢ Cut out : 3³⁰/₃₂" (100mm)

Accessories

H7-1
Honeycomb louver

BRANKO-B-110C-RTL



Article number	2318.214F-ACOT-84-AM	
	NON-IC	IC
Fixture Consumption	30W	25W
Current	700 (mA)	600 (mA)
Delivered Lumen	1932 (lm)	1695 (lm)
HE Delivered Lumen*	2434 (lm)	2118 (lm)
Beam Angle	25°/35°/45°/55° (Lens)	
CCT	3000K	
CRI	90+	
Driver Model	PUP40A-1WMC-850	

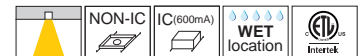

Dimmable

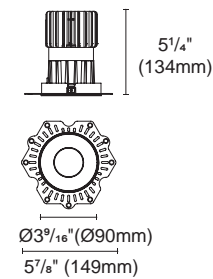

Ⓢ Cut out : 3³⁰/₃₂" (100mm)

Accessories

H7-1
Honeycomb louverACOT-109
Suction cupEP110-TL-WD
Millwork

BRANKO-A-110C-RTA



Article number	2318.135-ACOT-84-AM	
	NON-IC	IC
Fixture Consumption	30W	25W
Current	700 (mA)	600 (mA)
Delivered Lumen	1885 (lm)	1658 (lm)
HE Delivered Lumen*	2375 (lm)	2072 (lm)
Beam Angle	25°/35°/45°/55° (Lens)	
CCT	3000K	
CRI	90+	
Driver Model	PUP40A-1WMC-850	



Dimmable

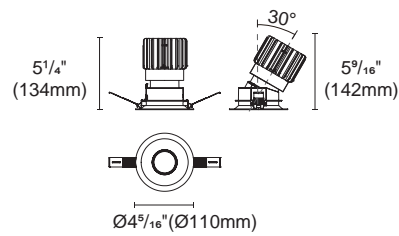

⊘ Cut out : 3³⁰/₃₂" (100mm)

Accessories

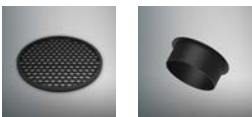

H7-1 Honeycomb louver ACSN-17 Snoot

BRANKO-B-110C-RTA



Article number	2318.137-ACOT-84-AM	
	NON-IC	IC
Fixture Consumption	30W	25W
Current	700 (mA)	600 (mA)
Delivered Lumen	1885 (lm)	1658 (lm)
HE Delivered Lumen*	2375 (lm)	2072 (lm)
Beam Angle	25°/35°/45°/55° (Lens)	
CCT	3000K	
CRI	90+	
Driver Model	PUP40A-1WMC-850	



Dimmable

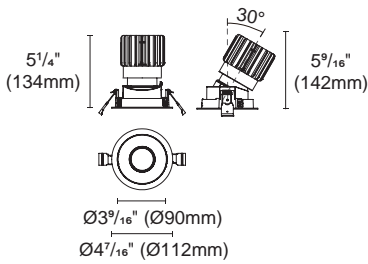

⊘ Cut out : 3³⁰/₃₂" (100mm)

Accessories



H7-1 Honeycomb louver ACSN-17 Snoot

BRANKO-B-110C-RTLA



Article number	2318.216F-ACOT-84-AM	
	NON-IC	IC
Fixture Consumption	30W	25W
Current	700 (mA)	600 (mA)
Delivered Lumen	1885 (lm)	1658 (lm)
HE Delivered Lumen*	2375 (lm)	2072 (lm)
Beam Angle	25°/35°/45°/55° (Lens)	
CCT	3000K	
CRI	90+	
Driver Model	PUP40A-1WMC-850	



Dimmable

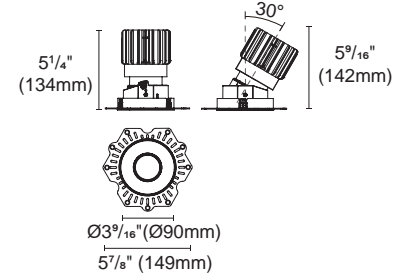

⊘ Cut out : 3³⁰/₃₂" (100mm)

Accessories



H7-1 Honeycomb louver ACSN-17 Snoot EP110-TL-WD Millwork

BRANKO-A-110P-RTF



Article number	2318.166-ACOT-84-AM	
	NON-IC	IC
Fixture Consumption	30W	25W
Current	700 (mA)	600 (mA)
Delivered Lumen	1803 (lm)	1600 (lm)
HE Delivered Lumen*	2271 (lm)	2000 (lm)
Beam Angle	25°/35°/45°/55° (Lens)	
CCT	3000K	
CRI	90+	
Driver Model	PUP40A-1WMC-850	

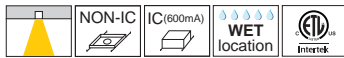

Dimmable

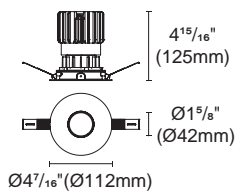

⊗ Cut out : 3³⁰/₃₂" (100mm)

Accessories

H7-1
Honeycomb louver

BRANKO-B-110P-RTF



Article number	2318.134-ACOT-84-AM	
	NON-IC	IC
Fixture Consumption	30W	25W
Current	700 (mA)	600 (mA)
Delivered Lumen	1803 (lm)	1600 (lm)
HE Delivered Lumen*	2271 (lm)	2000 (lm)
Beam Angle	25°/35°/45°/55° (Lens)	
CCT	3000K	
CRI	90+	
Driver Model	PUP40A-1WMC-850	

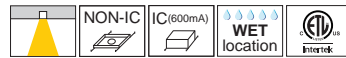

Dimmable

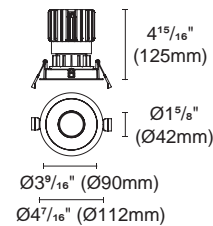

⊗ Cut out : 3³⁰/₃₂" (100mm)

Accessories

H7-1
Honeycomb louver

BRANKO-B-110P-RTL



Article number	2318.215F-ACOT-84-AM	
	NON-IC	IC
Fixture Consumption	30W	25W
Current	700 (mA)	600 (mA)
Delivered Lumen	1803 (lm)	1600 (lm)
HE Delivered Lumen*	2271 (lm)	2000 (lm)
Beam Angle	25°/35°/45°/55° (Lens)	
CCT	3000K	
CRI	90+	
Driver Model	PUP40A-1WMC-850	

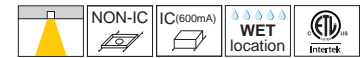

Dimmable

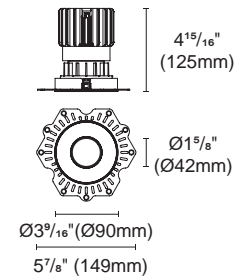

⊗ Cut out : 3³⁰/₃₂" (100mm)

Accessories

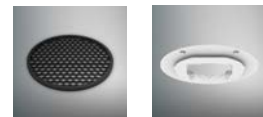
H7-1
Honeycomb louver
EP110-TL-WD
Millwork

BRANKO-A-110P-RTA



Article number	2318.136-ACOT-84-AM	
	NON-IC	IC
Fixture Consumption	30W	25W
Current	700 (mA)	600 (mA)
Delivered Lumen	1704 (lm)	1497 (lm)
HE Delivered Lumen*	2147 (lm)	1871 (lm)
Beam Angle	25°/35°/45°/50° (Lens)	
CCT	3000K	
CRI	90+	
Driver Model	PUP40A-1WMC-850	



Dimmable

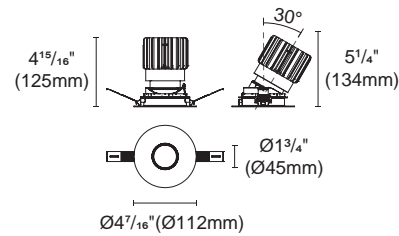

⊘ Cut out : 3³⁰/₃₂" (100mm)

Accessories

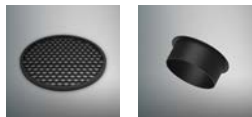

H7-1 Honeycomb louver ACSN-17 Snoot

BRANKO-B-110P-RTA



Article number	2318.138-ACOT-84-AM	
	NON-IC	IC
Fixture Consumption	30W	25W
Current	700 (mA)	600 (mA)
Delivered Lumen	1704 (lm)	1497 (lm)
HE Delivered Lumen*	2147 (lm)	1871 (lm)
Beam Angle	25°/35°/45°/50° (Lens)	
CCT	3000K	
CRI	90+	
Driver Model	PUP40A-1WMC-850	



Dimmable

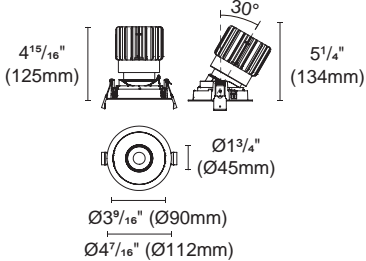

⊘ Cut out : 3³⁰/₃₂" (100mm)

Accessories

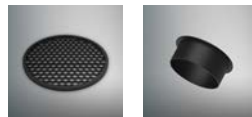

H7-1 Honeycomb louver ACSN-17 Snoot

BRANKO-B-110P-RTLTA



Article number	2318.217F-ACOT-84-AM	
	NON-IC	IC
Fixture Consumption	30W	25W
Current	700 (mA)	600 (mA)
Delivered Lumen	1704 (lm)	1497 (lm)
HE Delivered Lumen*	2147 (lm)	1871 (lm)
Beam Angle	25°/35°/45°/50° (Lens)	
CCT	3000K	
CRI	90+	
Driver Model	PUP40A-1WMC-850	

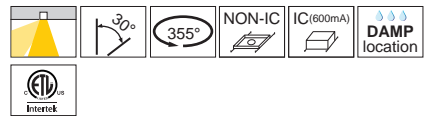

Dimmable

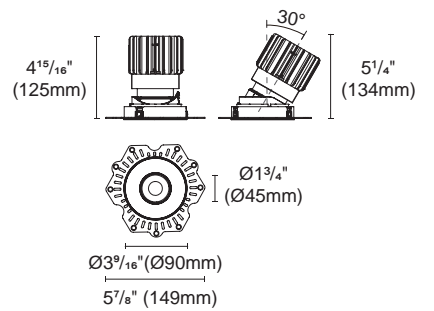

⊘ Cut out : 3³⁰/₃₂" (100mm)

Accessories



H7-1 Honeycomb louver ACSN-17 Snoot EP110-TL-WD Millwork

BRANKO-A-110C-STF



Article number	2418.119-ACOT-84-AM	
	NON-IC	IC
Fixture Consumption	30W	25W
Current	700 (mA)	600 (mA)
Delivered Lumen	1824 (lm)	1623 (lm)
HE Delivered Lumen*	2298 (lm)	2028 (lm)
Beam Angle	25°/35°/45°/55° (Lens)	
CCT	3000K	
CRI	90+	
Driver Model	PUP40A-1WMC-850	

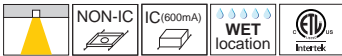

Dimmable

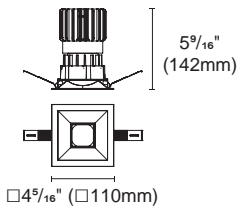

Cut out : 3³⁰/₃₂"X3³⁰/₃₂" (100X100mm)

Accessories

H7-1
Honeycomb louver

BRANKO-B-110C-STF



Article number	2418.113-ACOT-84-AM	
	NON-IC	IC
Fixture Consumption	30W	25W
Current	700 (mA)	600 (mA)
Delivered Lumen	1824 (lm)	1623 (lm)
HE Delivered Lumen*	2298 (lm)	2028 (lm)
Beam Angle	25°/35°/45°/55° (Lens)	
CCT	3000K	
CRI	90+	
Driver Model	PUP40A-1WMC-850	

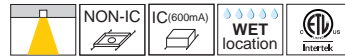

Dimmable

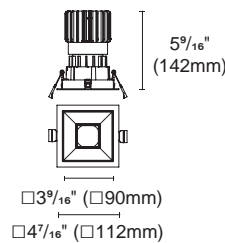

Cut out : 3³⁰/₃₂"X3³⁰/₃₂" (100X100mm)

Accessories

H7-1
Honeycomb louver

BRANKO-B-110C-STLF



Article number	2418.204A-ACOT-84-AM	
	NON-IC	IC
Fixture Consumption	30W	25W
Current	700 (mA)	600 (mA)
Delivered Lumen	1824 (lm)	1623 (lm)
HE Delivered Lumen*	2298 (lm)	2028 (lm)
Beam Angle	25°/35°/45°/55° (Lens)	
CCT	3000K	
CRI	90+	
Driver Model	PUP40A-1WMC-850	

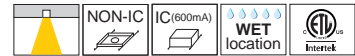

Dimmable

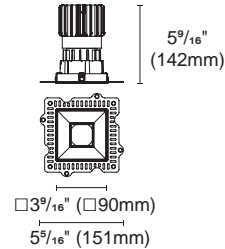

Cut out : 3³⁰/₃₂"X3³⁰/₃₂" (100X100mm)

Accessories

H7-1
Honeycomb louverEP110-TL-WD
Millwork

BRANKO-A-110C-STA



Article number	2418.121-ACOT-84-AM	
	NON-IC	IC
Fixture Consumption	30W	25W
Current	700 (mA)	600 (mA)
Delivered Lumen	1804 (lm)	1600 (lm)
HE Delivered Lumen*	2273 (lm)	2000 (lm)
Beam Angle	25°/35°/45°/55° (Lens)	
CCT	3000K	
CRI	90+	
Driver Model	PUP40A-1WMC-850	

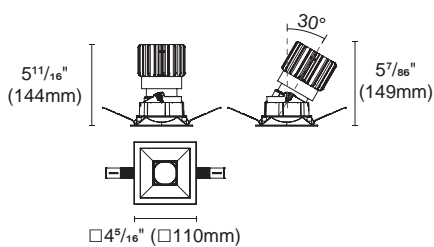

Dimmable

 Cut out : 3^{30/32}"X3^{30/32}" (100X100mm)

Accessories

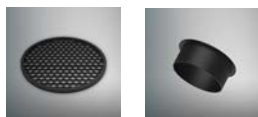
H7-1
Honeycomb louverACSN-17
Snoot

BRANKO-B-110C-STA



Article number	2418.115-ACOT-84-AM	
	NON-IC	IC
Fixture Consumption	30W	25W
Current	700 (mA)	600 (mA)
Delivered Lumen	1804 (lm)	1600 (lm)
HE Delivered Lumen*	2273 (lm)	2000 (lm)
Beam Angle	25°/35°/45°/55° (Lens)	
CCT	3000K	
CRI	90+	
Driver Model	PUP40A-1WMC-850	

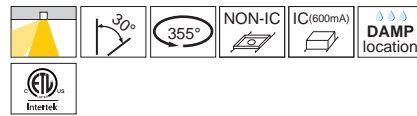

Dimmable

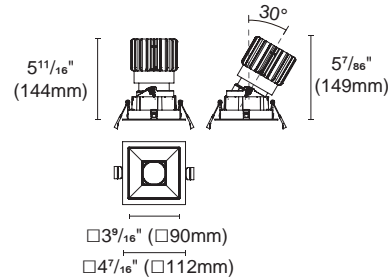
 Cut out : 3^{30/32}"X3^{30/32}" (100X100mm)

Accessories

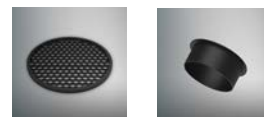
H7-1
Honeycomb louverACSN-17
Snoot

BRANKO-B-110C-STLA



Article number	2418.206A-ACOT-84-AM	
	NON-IC	IC
Fixture Consumption	30W	25W
Current	700 (mA)	600 (mA)
Delivered Lumen	1804 (lm)	1600 (lm)
HE Delivered Lumen*	2273 (lm)	2000 (lm)
Beam Angle	25°/35°/45°/55° (Lens)	
CCT	3000K	
CRI	90+	
Driver Model	PUP40A-1WMC-850	

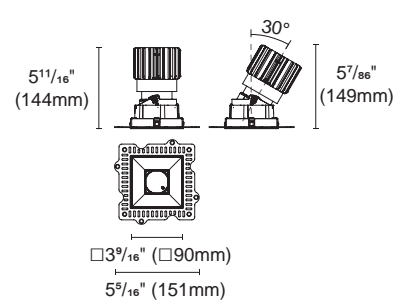

Dimmable

 Cut out : 3^{30/32}"X3^{30/32}" (100X100mm)

Accessories

H7-1
Honeycomb louverACSN-17
SnootEP110-TL-WD
Millwork

BRANKO-A-110P-STF



Article number	2418.120-ACOT-84-AM	
	NON-IC	IC
Fixture Consumption	30W	25W
Current	700 (mA)	600 (mA)
Delivered Lumen	1826 (lm)	1618 (lm)
HE Delivered Lumen*	2300 (lm)	2022 (lm)
Beam Angle	25°/35°/45°/55° (Lens)	
CCT	3000K	
CRI	90+	
Driver Model	PUP40A-1WMC-850	

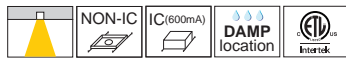

Dimmable

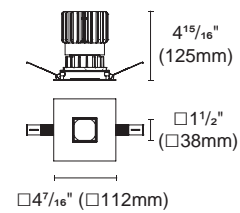

△ Cut out : 3^{30/32}"X3^{30/32}" (100X100mm)

Accessories



H7-1 Honeycomb louver

BRANKO-B-110P-STF



Article number	2418.114-ACOT-84-AM	
	NON-IC	IC
Fixture Consumption	30W	25W
Current	700 (mA)	600 (mA)
Delivered Lumen	1826 (lm)	1618 (lm)
HE Delivered Lumen*	2300 (lm)	2022 (lm)
Beam Angle	25°/35°/45°/55° (Lens)	
CCT	3000K	
CRI	90+	
Driver Model	PUP40A-1WMC-850	

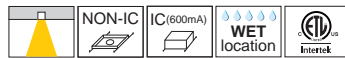

Dimmable

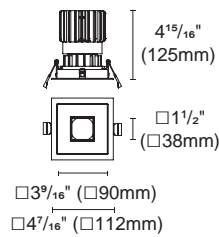

△ Cut out : 3^{30/32}"X3^{30/32}" (100X100mm)

Accessories



H7-1 Honeycomb louver

BRANKO-B-110P-STLF



Article number	2418.205A-ACOT-84-AM	
	NON-IC	IC
Fixture Consumption	30W	25W
Current	700 (mA)	600 (mA)
Delivered Lumen	1826 (lm)	1618 (lm)
HE Delivered Lumen*	2300 (lm)	2022 (lm)
Beam Angle	25°/35°/45°/55° (Lens)	
CCT	3000K	
CRI	90+	
Driver Model	PUP40A-1WMC-850	

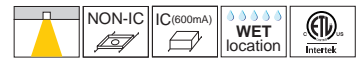

Dimmable

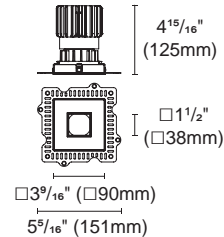

△ Cut out : 3^{30/32}"X3^{30/32}" (100X100mm)

Accessories

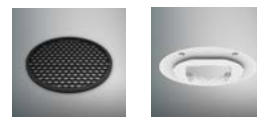

H7-1 Honeycomb louver EP110-TL-WD Millwork

BRANKO-A-110P-STA



Article number	2318.153-ACOT-84-AM	
	NON-IC	IC
Fixture Consumption	30W	25W
Current	700 (mA)	600 (mA)
Delivered Lumen	1728 (lm)	1597 (lm)
HE Delivered Lumen*	2177 (lm)	1996 (lm)
Beam Angle	25°/35°/45°/50° (Lens)	
CCT	3000K	
CRI	90+	
Driver Model	PUP40A-1WMC-850	

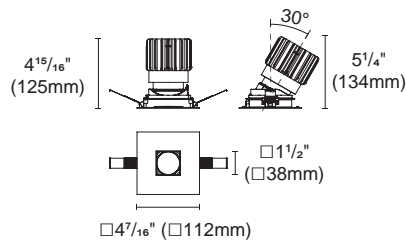

Dimmable

 Cut out : 3³⁰/₃₂"X3³⁰/₃₂" (100X100mm)

Accessories

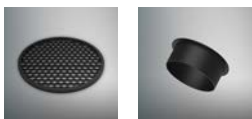

H7-1 Honeycomb louver
ACSN-17 Snoot

BRANKO-B-110P-STA



Article number	2318.154-ACOT-84-AM	
	NON-IC	IC
Fixture Consumption	30W	25W
Current	700 (mA)	600 (mA)
Delivered Lumen	1728 (lm)	1597 (lm)
HE Delivered Lumen*	2177 (lm)	1996 (lm)
Beam Angle	25°/35°/45°/50° (Lens)	
CCT	3000K	
CRI	90+	
Driver Model	PUP40A-1WMC-850	

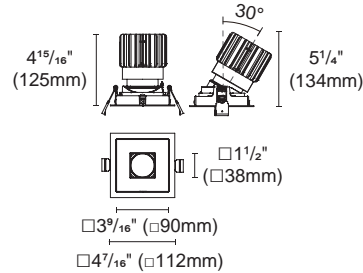

Dimmable

 Cut out : 3³⁰/₃₂"X3³⁰/₃₂" (100X100mm)

Accessories

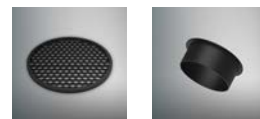

H7-1 Honeycomb louver
ACSN-17 Snoot

BRANKO-B-110P-STLA



Article number	2318.218A-ACOT-84-AM	
	NON-IC	IC
Fixture Consumption	30W	25W
Current	700 (mA)	600 (mA)
Delivered Lumen	1728 (lm)	1597 (lm)
HE Delivered Lumen*	2177 (lm)	1996 (lm)
Beam Angle	25°/35°/45°/50° (Lens)	
CCT	3000K	
CRI	90+	
Driver Model	PUP40A-1WMC-850	

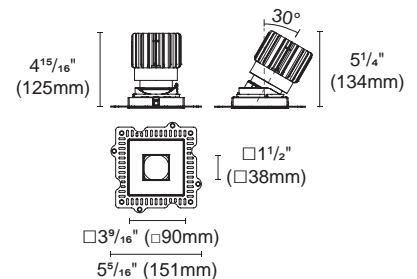

Dimmable

 Cut out : 3³⁰/₃₂"X3³⁰/₃₂" (100X100mm)

Accessories



H7-1 Honeycomb louver
ACSN-17 Snoot
EP110-TL-WD Millwork

INSTALLATION OPTIONS



ACCG-28B-PUP10A-1WMC-350 0/1-10V
 ACCG-28B-PUP10D-1WMC-350 DALI
 ACCG-28B-PUP10T-1LMC-350 TRIAC
 for BRANKO65-2"
 Type: Gear box

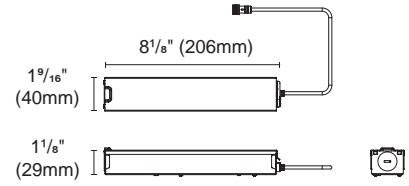

Internal space dimension:
 L 4 1/4" (108mm) X W 1 3/8" (35mm) X H 1" (26mm)



ACCG-22B-PUP20A-1WMC 0/1-10V
 ACCG-22B-PUP20D-1WMC DALI
 ACCG-22B-PUP20T-1LMC TRIAC
 for BRANKO85-2.8"
 BRANKO110-3.5" (18-21W)
 Type: Gear box

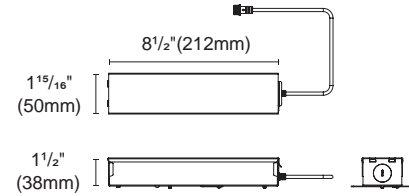

Internal space dimension:
 L 8 1/4" (209mm) X W 1 7/8" (48mm) X H 1 5/16" (33mm)



ACCG-35B-PUP20A-1WMC 0/1-10V
 ACCG-35B-PUP20D-1WMC DALI
 ACCG-35B-PUP20T-1LMC TRIAC
 for BRANKO85-2.8"
 BRANKO110-3.5" (18-21W)
 Type: Gear box

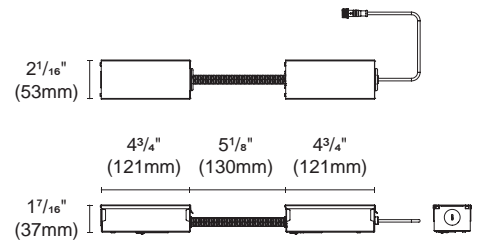

* Use with low ceilings



ACCG-16B-PUP40A-1WMC-850 0/1-10V
 ACCG-16B-PUP40D-1WMC-850 DALI
 ACCG-16B-PUP40T-1LMC-850 TRIAC
 for BRANKO110-3.5" (30W)
 Type: Gear box

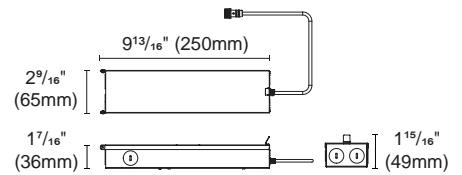

Internal space dimension:
 L 9 13/16" (250mm) X W 2 1/2" (64mm) X H 1 5/16" (34mm)

* For single fixture connection only, not available for parallel multiple connection



ACCH-12-60 for BRANKO65-2"
 Type: New construction plate

Cut out:

Round : $\varnothing 2^{12}/_{32}$ " ($\varnothing 60$ mm)

Square : $\square 2^{12}/_{32}$ " ($\square 60$ mm)

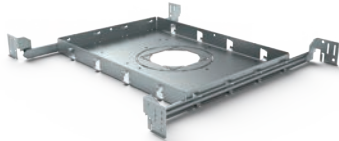
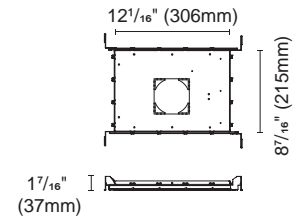

ACCH-12-80 for BRANKO85-2.8"
 Type: New construction plate

Cut out:

Round : $\varnothing 3^{5}/_{32}$ " ($\varnothing 80$ mm)

Square : $\square 3^{5}/_{32}$ " ($\square 80$ mm)

Also for Millwork

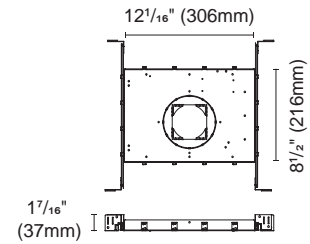

ACCH-12H-100 for BRANKO110-3.5"
 Type: New construction plate

Cut out:

Round : $\varnothing 3^{30}/_{32}$ " ($\varnothing 100$ mm)

Square : $\square 3^{30}/_{32}$ " ($\square 100$ mm)

Also for Millwork

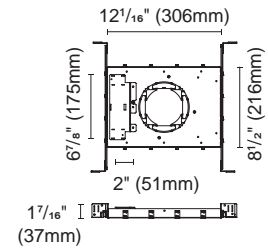

INSTALLATION OPTIONS

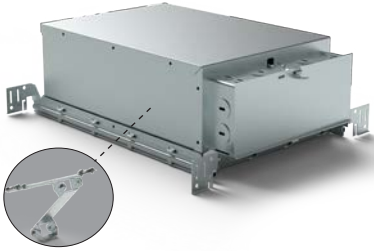

Driver is secured on patent designed bracket

ACCH-12D-60-PUP10A-1WMC-350 0/1-10V
 ACCH-12D-60-PUP10D-1WMC-350 DALI
 ACCH-12D-60-PUP10T-1LMC-350 TRIAC
 for BRANKO65-2"

Type: IC Box

Cut out:

Round : $\varnothing 2\frac{1}{2}$ " ($\varnothing 60$ mm)

Square : $\square 2\frac{1}{2}$ " ($\square 60$ mm)

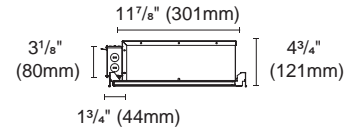
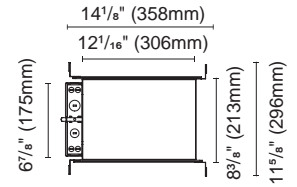

ACCH-12D-80-PUP20A-1WMC 0/1-10V
 ACCH-12D-80-PUP20D-1WMC DALI
 ACCH-12D-80-PUP20T-1LMC TRIAC
 for BRANKO85-2.8"

Type: IC Box

Cut out:

Round : $\varnothing 3\frac{5}{8}$ " ($\varnothing 80$ mm)

Square : $\square 3\frac{5}{8}$ " ($\square 80$ mm)

Also for Millwork



ACCH-12B-100-PUP20A-1WMC 0/1-10V
 ACCH-12B-100-PUP20D-1WMC DALI
 ACCH-12B-100-PUP20T-1LMC TRIAC
 for BRANKO110-3.5" (18-21W)

Type: IC Box

Cut out:

Round : $\varnothing 3\frac{30}{32}$ " ($\varnothing 100$ mm)

Square : $\square 3\frac{30}{32}$ " ($\square 100$ mm)

Also for Millwork

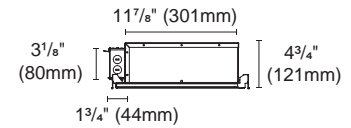
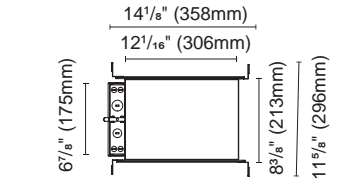

ACCH-7B-100-PUP40A-1WMC-850 0/1-10V
 ACCH-7B-100-PUP40D-1WMC-850 DALI
 ACCH-7B-100-PUP40T-1LMC-850 TRIAC
 for BRANKO110-3.5" (25W)

Type: IC Box

Cut out:

Round : $\varnothing 3\frac{30}{32}$ " ($\varnothing 100$ mm)

Square : $\square 3\frac{30}{32}$ " ($\square 100$ mm)

Also for Millwork

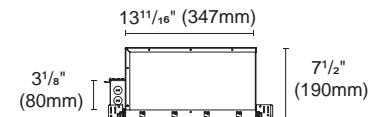
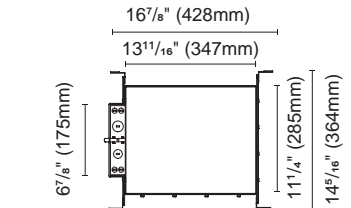



ACCI-3
Type: Emergency battery holder
For BillDa emergency led driver-
Model NO. BLD-HM08D-YYY
BLD-HM15D-YYY
BLD-HM20D-YYY
BLD-HM25D-YYY

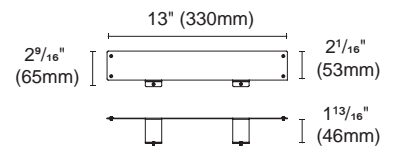

ACCI-5
Type: Remodel stand

