

EPIC SERIES (EU)



EPIC (EU)

Designed base on the concept of “light engine modularization”, making EPIC series possible to be more flexible, more practical and expandable.

The features are as follows:

- * Modularized design—easy maintenance & replacement
- * Maximize common components to reduce stock cost
- * Speed up the progress of new series development in the future
- * Interchangeable design to increase product flexibility
- * Set up design norms by modularization, minimize possible faults



EPIC 65/85/110/135
Recessed downlights



ACOT-68



ACOT-69-WCW
Tunable white



ACOT-70
ACOT-70A Narrow beam
ACOT-70-WCW Tunable white

65
Fixed

65
Adjustable

85
Fixed

85
Adjustable

85
Wallwash

Round

Trim



Trimless



Square

Trim



Trimless





LEE-15
LEE-15A Narrow beam
LEE-15-DW Dim to warm



ACOT-72
ACOT-72-WCW Tunable white



ACOT-73
ACOT-73-WCW Tunable white

110
Fixed

110
Adjustable

110
Wallwash

135
Fixed

135
Adjustable

135
Wallwash

Round

Trim



Trimless



Square

Trim



Trimless



EPIC (EU)

Light source
CRI 90
2700 or 3000 or 4000 Kelvin
Tunable White

Lens
10°
15°
20°-30°
30°-40°
40°-50°
50°-60°

Accessories
Diffusion sheet
Striped glass
Woven glass
Honeycomb louver



Round or Square
Fixed
Adjustable 0°-30°

Material available
Aluminium die cast : White/ Black/ Haze/ Gold
Plastic : Chrome



Round or Square
Trim or Trimless

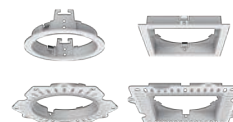



Prevent light leak

Adding an extra component to the fixture prevent people seeing through the fixture a very tender thought from our designer

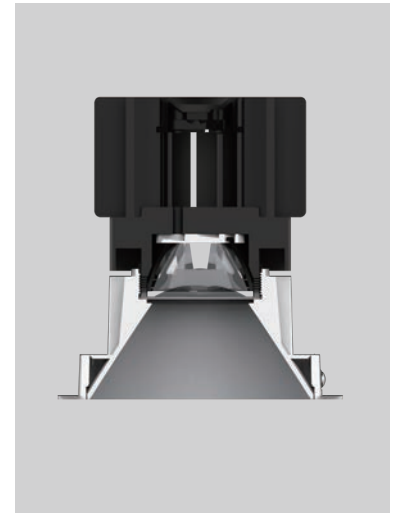
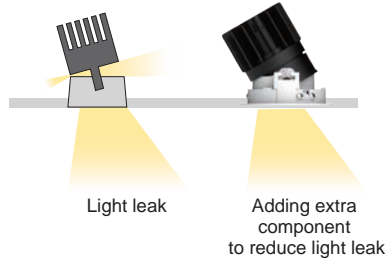

Material and color

Trim: Aluminium die cast, White/ Black



Baffle finish :

1. Aluminium die cast : White/ Black/ Haze/ Gold
2. Plastic : Chrome

Optics

Deep baffle design helps reduce glare, equipped with special selected lens, the light is evenly spread to achieve the beam angle needed, making EPIC a unique series.

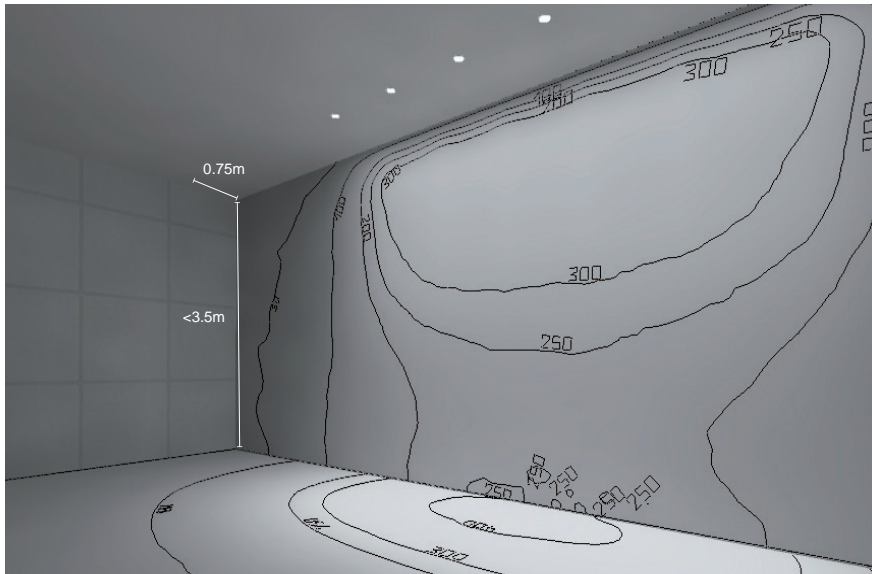

Wallwash

EPIC a wallwash enables even illumination on the target wall without shadows. It supplies an overall effect that is clean and elegant. Generally speaking, the distance between the lighting fixture and the height of the illuminated wall ranges from 1/3 to 1/5. This wallwash function; not only broadens the illumination effect with smooth lights performance but also makes the entire area feels brighter. When combining with other function fixtures together, it can form a fusion of beauty.

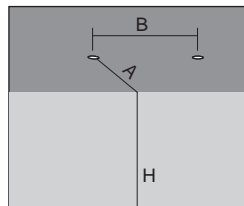
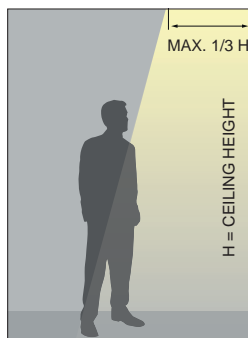
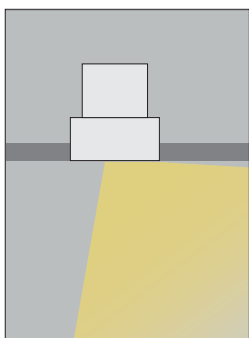

RECOMMENDED DISTANCES (Meter)

A : H : B 0.75 : <math><3.5</math> : 0.75 (m)

Advantage of light With narrow beam



The narrower the angle, the better the condensing effect. As the beam is more focused, it maintains its intensity over greater distances, allowing the light to travel further. It helps to effectively reduce the overflow of light, make the light spot slender and clean, and achieve an excellent focused lighting effect. It is suitable for where the application needs narrow beam lights, such as artworks, indoor landscapes, museums, galleries, and showcases.

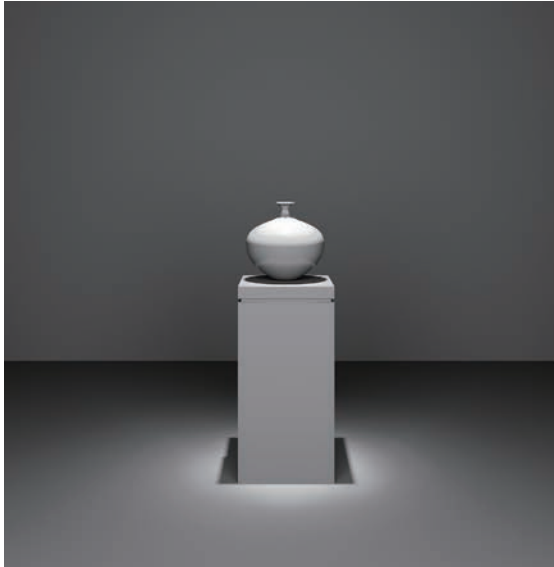

Ultra narrow beam



Standard beam

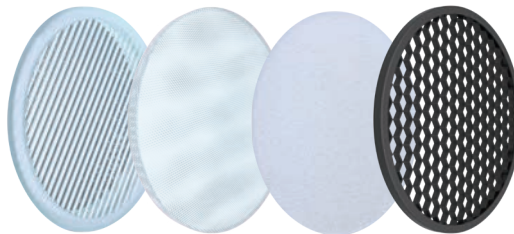

Striped glass Woven glass Diffusion sheet Honeycomb louver

With more options to the accessories, epic adds more flexibility and freedom for the lighting designer. Honeycomb reduces glare; strip glass creates oval distribution; Diffusion sheet & woven glass soften and even spread the light.

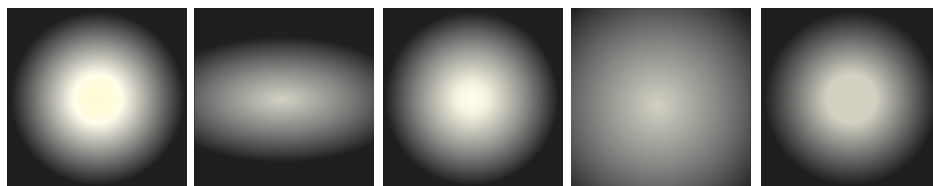

Lens (no accessory) Striped glass Woven glass Diffusion sheet Honeycomb louver



Dim to warm

This light engine features Dim to Warm, the ultimate in dimming comfort, where the light changes its colour temperature according to the dimming curve; the darker the light, the warmer the light. Like a sunset effect, the gradual change replicates the transition from a comfortable ambience to a relaxing and soothing environment.

Dim to Warm is the term used to describe the function of LEDs to reduce the colour temperature (CCT) of the light as it dims, from 3000K at 100% to 1800K at nearly 0%.

The light provides a relaxing ambience for a typical evening dining experience, reading in bed, a moody hotel lobby or bar environment. By moving from dim to warm, we provide a light source that is alert and bright when cooking or working, then dimmed to provide a warm ambience for hosting and relaxing in the evening.

Tunable white

Changes in light colour can have a significant impact on our mood. This light engine with Tunable White drivers allows the colour temperature to be continuously adjusted from 2700 K (warm light) to 6500 K (cool light) to provide uniform, high quality lighting that dynamically adjusts to the time of day or ambient brightness. It allows designers to simulate daylight for productivity and well-being, retailers to influence shoppers' behaviour, and luminaire manufacturers to simulate the familiar glow and dimming of incandescent lamps.



Easy installation

Easy to replace, quick to assemble and completely tool-free.



Hole size doesn't match? No worries!

Your installation "Rescue Ring" is here!

During lighting installation, one of the most frustrating issues is dealing with old ceiling cutouts that don't match the new fixture size—or when the hole was accidentally cut too large.

Now you don't need to redo the ceiling or settle for uneven gaps.

Our Goof ring is designed exactly for this situation!

One Goof ring is all you need for a perfect fit!

Whether you're reusing an existing opening or correcting a cutting mistake, this "Goof ring" ensures your lighting still looks flawless, consistent, and beautifully integrated.

Simply install the trim ring before mounting the light.

It helps you:

- Perfectly cover oversized cutouts
- Hide installation errors for a clean finish
- Blend seamlessly with your light fixture
- Install quickly—saving time and effort

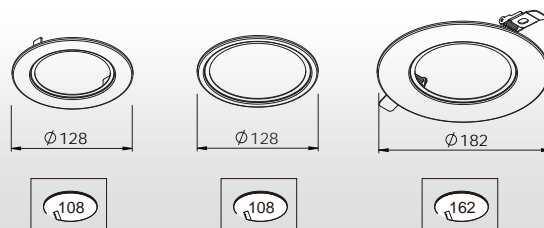

* This accessory is also compatible with various related sizes of recessed downlights.



EP85-GOOFRING-4

for **85**



EP110-GOOFRING-4

for **110**

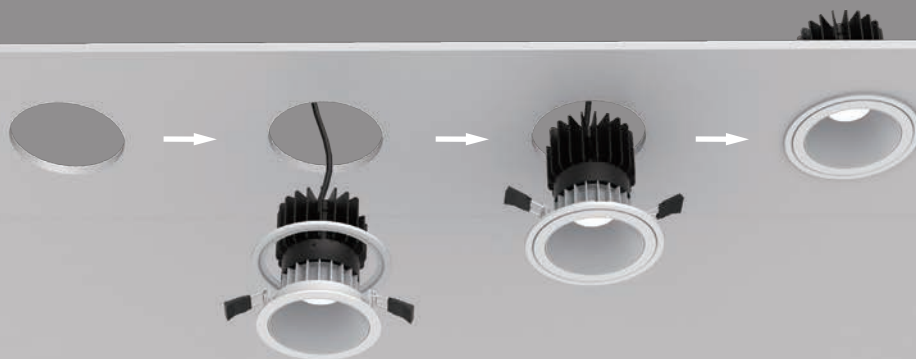

EP110-GOOFRING-6

for **110**

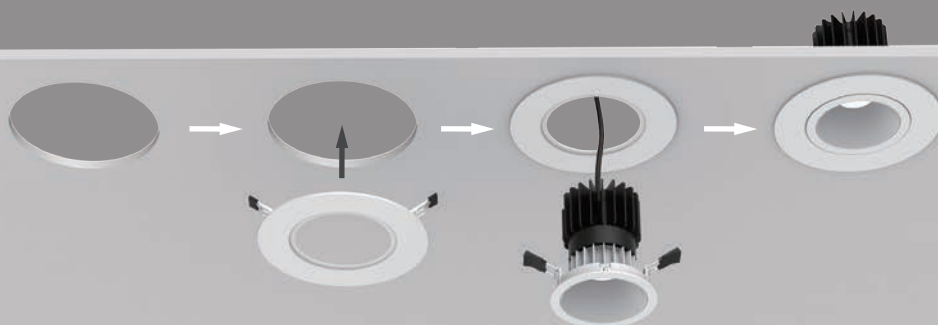

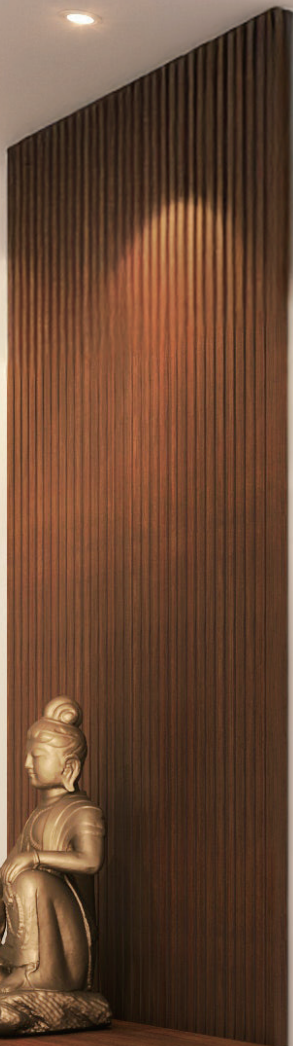

EPIC-65 ▶

Round / Square

Fixed

Adjustable

EPIC-65 Round-Fixed

EPIC-65-RTF
EPIC-65-RTL



Colours

Bezel : Black White

Baffle : Black White

Haze Gold Chrome

Article number	LED Consumption	Current	LED Lumen	Delivered Lumen	Beam Angle	CCT	CRI
Trim							
2118.100-ACOT-68	10W	250 mA	913 lm	766 lm	20°/40°/55° (Lens)	3000K	90+
2118.100-ACOT-69-WCW	10W	250 mA	680-882 lm	-	20°/40°/55° (Lens)	2700-6500K	90+
Trimless							
2118.200F-ACOT-68	10W	250 mA	913 lm	766 lm	20°/40°/55° (Lens)	3000K	90+
2118.200F-ACOT-69-WCW	10W	250 mA	680-882 lm	-	20°/40°/55° (Lens)	2700-6500K	90+

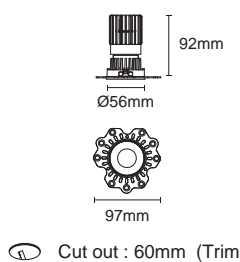
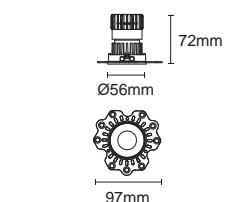
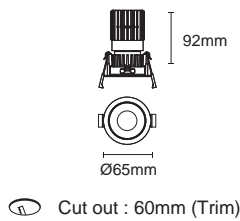
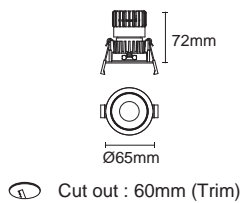

Dimmable



Optional Accessory

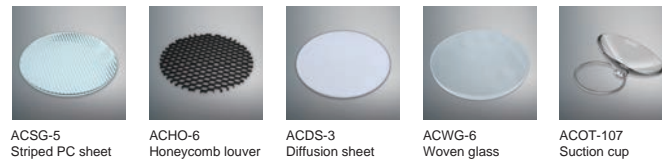

IES



Fixed UGR<13

2118.100-ACOT-68
2118.200F-ACOT-68

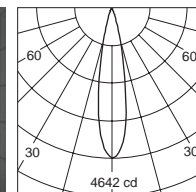
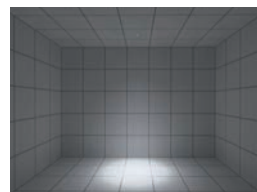

H(m)	D(m)	E(lx)
20°		
1.0	0.36	4633
2.0	0.72	1158
3.0	1.08	514
4.0	1.44	289
5.0	1.80	185



Fixed UGR<16

2118.100-ACOT-68
2118.200F-ACOT-68

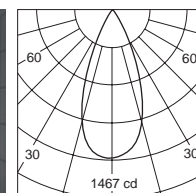
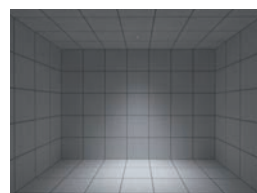

H(m)	D(m)	E(lx)
40°		
1.0	0.77	1465
2.0	1.55	366
3.0	2.32	162
4.0	3.10	91
5.0	3.87	58



Fixed UGR<22

2118.100-ACOT-68
2118.200F-ACOT-68

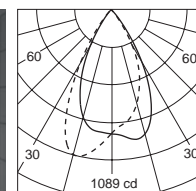
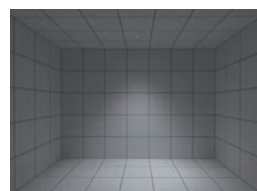

H(m)	D(m)	E(lx)
55°		
1.0	0.94	1022
2.0	1.89	255
3.0	2.83	113
4.0	3.78	63
5.0	4.72	40

EPIC-65 Round-Adjustable

EPIC-65-RTA
EPIC-65-RTL



Colours

- Bezel : Black White
 Baffle : Black White
 Haze Gold Chrome

Article number	LED Consumption	Current	LED Lumen	Delivered Lumen	Beam Angle	CCT	CRI
Trim							
2118.101-ACOT-68	10W	250 mA	913 lm	767 lm	20°/40°/55° (Lens)	3000K	90+
2118.101-ACOT-69-WCW	10W	250 mA	680-882 lm	-	20°/40°/55° (Lens)	2700-6500K	90+
Trimless							
2118.201F-ACOT-68	10W	250 mA	913 lm	767 lm	20°/40°/55° (Lens)	3000K	90+
2118.201F-ACOT-69-WCW	10W	250 mA	680-882 lm	-	20°/40°/55° (Lens)	2700-6500K	90+

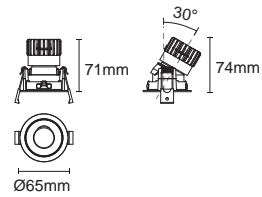

Ø65mm
Cut out : 60mm (Trim)

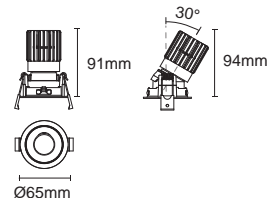

Ø65mm
Cut out : 60mm (Trim)

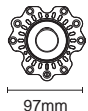
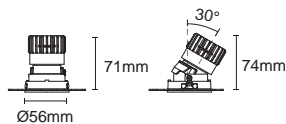

Ø56mm
Cut out : 60mm (Trimless)

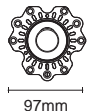
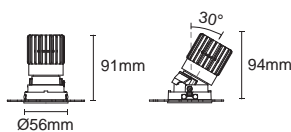

Ø56mm
Cut out : 60mm (Trimless)

Dimmable

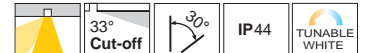

Optional Accessory

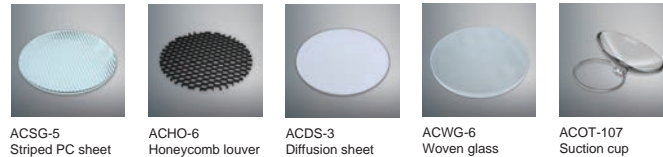

IES



Adjustable

2118.101-ACOT-68
2118.201F-ACOT-68

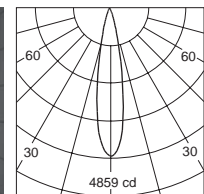
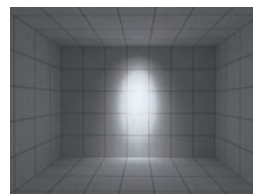

H(m)	D(m)	E(lx)
20°		
1.0	0.35	4878
2.0	0.69	1220
3.0	1.04	542
4.0	1.38	305
5.0	1.73	195



Adjustable

2118.101-ACOT-68
2118.201F-ACOT-68

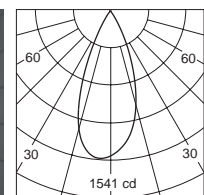
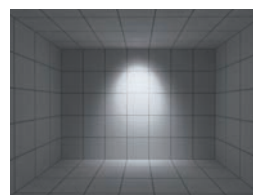

H(m)	D(m)	E(lx)
40°		
1.0	0.75	1540
2.0	1.50	384
3.0	2.26	171
4.0	3.01	96
5.0	3.76	61



Adjustable

2118.101-ACOT-68
2118.201F-ACOT-68

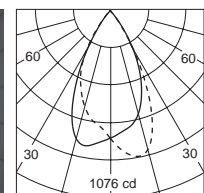
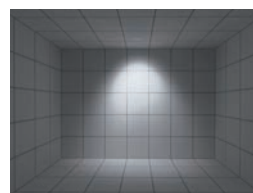

H(m)	D(m)	E(lx)
55°		
1.0	0.95	1017
2.0	1.89	254
3.0	2.84	113
4.0	3.78	63
5.0	4.73	40

EPIC-65 Square-Fixed

EPIC-65-STF
EPIC-65-STLF



Colours

Bezel : Black White

Baffle : Black White

Haze Gold

Article number	LED Consumption	Current	LED Lumen	Delivered Lumen	Beam Angle	CCT	CRI
Trim							
2118.103-ACOT-68	10W	250 mA	913 lm	796 lm	20°/40°/55° (Lens)	3000K	90+
2118.103-ACOT-69-WCW	10W	250 mA	680-882 lm	-	20°/40°/55° (Lens)	2700-6500K	90+
Trimless							
2118.203A-ACOT-68	10W	250 mA	913 lm	796 lm	20°/40°/55° (Lens)	3000K	90+
2118.203A-ACOT-69-WCW	10W	250 mA	680-882 lm	-	20°/40°/55° (Lens)	2700-6500K	90+

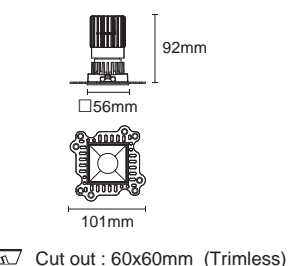
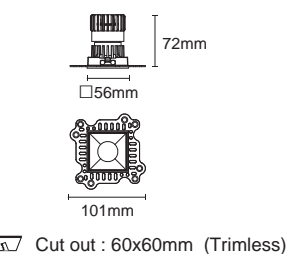
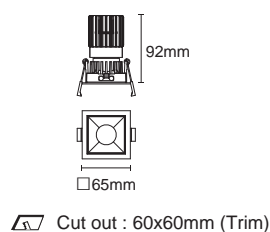
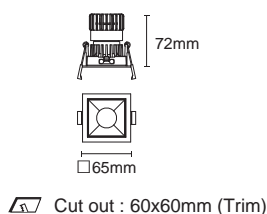

Dimmable



Optional Accessory



ACSG-5 Striped PC sheet

ACHO-6 Honeycomb louver

ACDS-3 Diffusion sheet

ACWG-6 Woven glass

ACOT-107 Suction cup

IES



Fixed UGR<16

2118.103-ACOT-68
2118.203A-ACOT-68

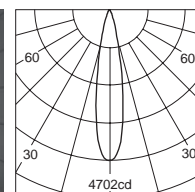
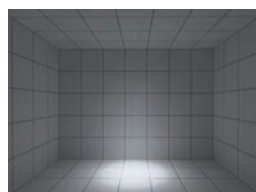

H(m)	D(m)	E(lx)
20°		
1.0	0.35	4705
2.0	0.70	1176
3.0	1.05	522
4.0	1.39	294
5.0	1.74	188



Fixed UGR<16

2118.103-ACOT-68
2118.203A-ACOT-68

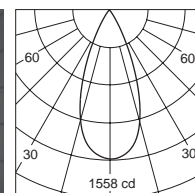
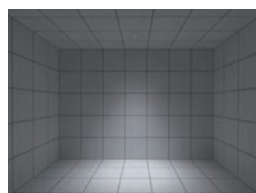

H(m)	D(m)	E(lx)
40°		
1.0	0.77	1558
2.0	1.53	389
3.0	2.30	173
4.0	3.07	97
5.0	3.83	62



Fixed UGR<22

2118.103-ACOT-68
2118.203A-ACOT-68

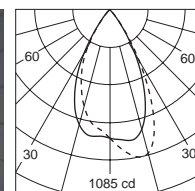
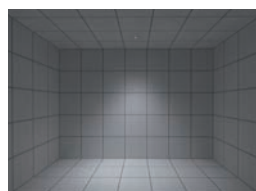

H(m)	D(m)	E(lx)
55°		
1.0	0.93	1020
2.0	1.87	255
3.0	2.80	113
4.0	3.73	63
5.0	4.67	40

EPIC-65 Square-Adjustable

EPIC-65-STA
EPIC-65-STLA



Colours

- Bezel: Black White
 Baffle: Black White
 Haze: Gold

Article number	LED Consumption	Current	LED Lumen	Delivered Lumen	Beam Angle	CCT	CRI
Trim							
2118.104-ACOT-68	10W	250 mA	913 lm	755 lm	20°/40°/55° (Lens)	3000K	90+
2118.104-ACOT-69-WCW	10W	250 mA	680-882 lm	-	20°/40°/55° (Lens)	2700-6500K	90+
Trimless							
2118.204A-ACOT-68	10W	250 mA	913 lm	755 lm	20°/40°/55° (Lens)	3000K	90+
2118.204A-ACOT-69-WCW	10W	250 mA	680-882 lm	-	20°/40°/55° (Lens)	2700-6500K	90+

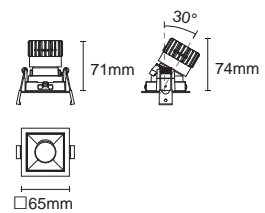

Cut out : 60x60mm (Trim)

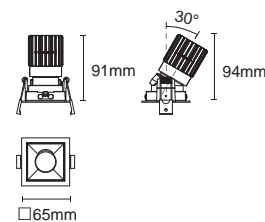

Cut out : 60x60mm (Trimless)

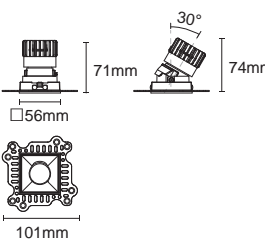

Cut out : 60x60mm (Trimless)

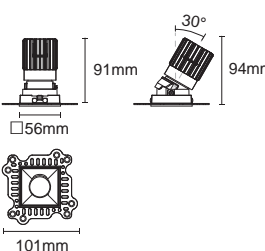

Cut out : 60x60mm (Trimless)

Dimmable



Optional Accessory



ACSG-5 Striped PC sheet ACHO-6 Honeycomb louver ACDS-3 Diffusion sheet ACWG-6 Woven glass ACOT-107 Suction cup

IES



Adjustable

2118.104-ACOT-68
2118.204A-ACOT-68

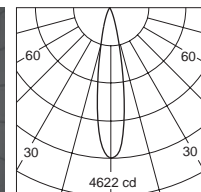
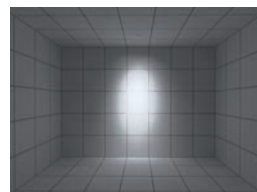

H(m)	D(m)	E(lx)
20°		
1.0	0.35	4619
2.0	0.69	1155
3.0	1.04	513
4.0	1.38	288
5.0	1.73	184



Adjustable

2118.104-ACOT-68
2118.204A-ACOT-68

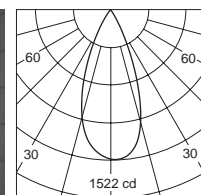
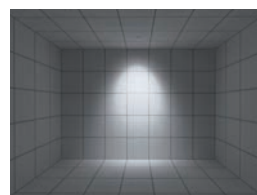

H(m)	D(m)	E(lx)
40°		
1.0	0.76	1521
2.0	1.52	380
3.0	2.27	169
4.0	3.03	95
5.0	3.79	60



Adjustable

2118.104-ACOT-68
2118.204A-ACOT-68

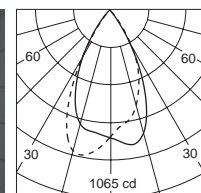
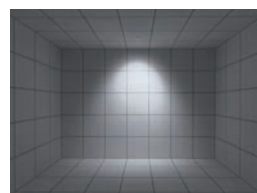

H(m)	D(m)	E(lx)
55°		
1.0	0.95	1021
2.0	1.90	255
3.0	2.85	113
4.0	3.81	63
5.0	4.76	40



EPIC-85 ▶

Round / Square

Fixed

Adjustable

Wallwash

EPIC-85 Round-Fixed

EPIC-85-RTF
EPIC-85-RTL



Colours

Bezel : Black White

Baffle : Black White

Haze Gold Chrome

Article number	LED Consumption	Current	LED Lumen	Delivered Lumen	Beam Angle	CCT	CRI
Trim							
 2118.106-ACOT-70A	10W	800 mA	774 lm	526 lm	13° (Lens)	3000K	90+
2118.106-ACOT-70	12W	350 mA	1446 lm	1265 lm	30°/50°/60° (Lens)	3000K	90+
2118.106-ACOT-70-WCW	13W	350 mA	1143-1356 lm	622-725 lm	30°/40°/50° (Lens)	2700-6500K	90+
Trimless							
 2118.206F-ACOT-70A	10W	800 mA	774 lm	526 lm	13° (Lens)	3000K	90+
2118.206F-ACOT-70	12W	350 mA	1446 lm	1265 lm	30°/50°/60° (Lens)	3000K	90+
2118.206F-ACOT-70-WCW	13W	350 mA	1143-1356 lm	622-725 lm	30°/40°/50° (Lens)	2700-6500K	90+

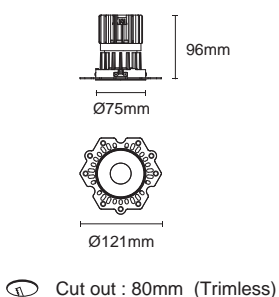
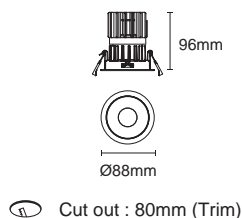

Dimmable



Optional Accessory

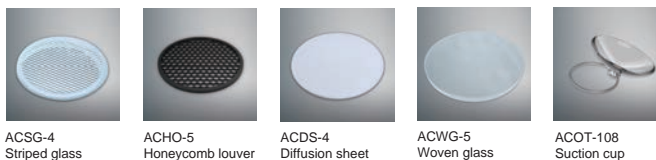

ACSC-4
Striped glass

ACHO-5
Honeycomb louver

ACDS-4
Diffusion sheet

ACWG-5
Woven glass

ACOT-108
Suction cup

 **13°**

Fixed UGR<10
 2118.106-ACOT-70A
 2118.206F-ACOT-70A

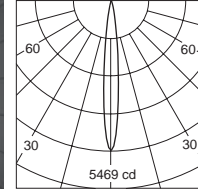
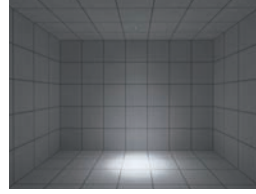

H(m)	D(m)	E(lx)
13°		
1.0	0.23	5576
2.0	0.46	1394
3.0	0.70	619
4.0	0.93	348
5.0	1.16	223

 **30°**

Fixed UGR<19
 2118.106-ACOT-70
 2118.206F-ACOT-70

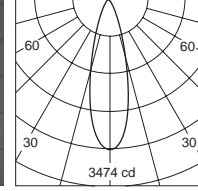
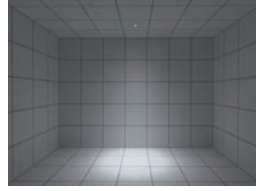

H(m)	D(m)	E(lx)
30°		
1.0	0.50	3470
2.0	1.01	867
3.0	1.51	385
4.0	2.01	216
5.0	2.52	138

 **50°**

Fixed UGR<19
 2118.106-ACOT-70
 2118.206F-ACOT-70

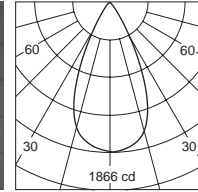
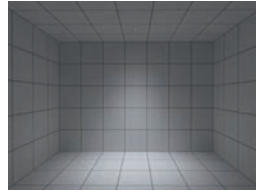

H(m)	D(m)	E(lx)
50°		
1.0	0.92	1862
2.0	1.84	465
3.0	2.76	206
4.0	3.67	116
5.0	4.59	74

 **60°**

Fixed UGR<22
 2118.106-ACOT-70
 2118.206F-ACOT-70

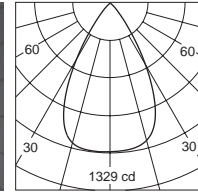
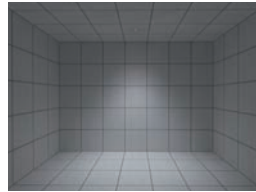

H(m)	D(m)	E(lx)
60°		
1.0	1.14	1301
2.0	2.27	325
3.0	3.41	144
4.0	4.54	81
5.0	5.68	52

EPIC-85 Round-Adjustable

EPIC-85-RTA
EPIC-85-RTLA



Colours

Bezel : Black White

Baffle : Black White

Haze Gold Chrome

Article number	LED Consumption	Current	LED Lumen	Delivered Lumen	Beam Angle	CCT	CRI
Trim							
 2118.107-ACOT-70A	10W	800 mA	774 lm	-	10° (Lens)	3000K	90+
2118.107-ACOT-70	12W	350 mA	1446 lm	1124 lm	30°/50°/60° (Lens)	3000K	90+
2118.107-ACOT-70-WCW	13W	350 mA	1143-1356 lm	607-707 lm	30°/40°/50° (Lens)	2700-6500K	90+
Trimless							
 2118.207F-ACOT-70A	10W	800 mA	774 lm	-	10° (Lens)	3000K	90+
2118.207F-ACOT-70	12W	350 mA	1446 lm	1124 lm	30°/50°/60° (Lens)	3000K	90+
2118.207F-ACOT-70-WCW	13W	350 mA	1143-1356 lm	607-707 lm	30°/40°/50° (Lens)	2700-6500K	90+

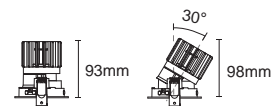

Ⓢ Cut out : 80mm (Trim)

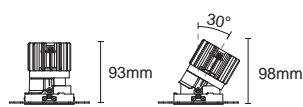

Ⓢ Cut out : 80mm (Trimless)

Dimmable



Optional Accessory



ACSG-4
Striped glass

ACHO-5
Honeycomb louver

ACDS-4
Diffusion sheet

ACWG-5
Woven glass

ACOT-108
Suction cup

 30°

Adjustable

2118.107-ACOT-70
2118.207F-ACOT-70

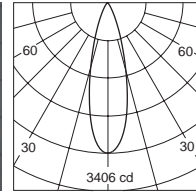
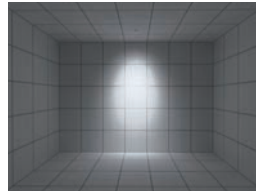

H(m)	D(m)	E(lx)
30°		
1.0	0.49	3409
2.0	0.98	852
3.0	1.46	378
4.0	1.95	213
5.0	2.44	136

 50°

Adjustable

2118.107-ACOT-70
2118.207F-ACOT-70

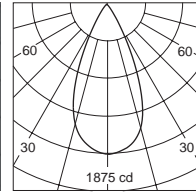
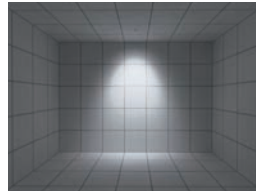

H(m)	D(m)	E(lx)
50°		
1.0	0.87	1876
2.0	1.73	469
3.0	2.60	208
4.0	3.46	117
5.0	4.33	75

 60°

Adjustable

2118.107-ACOT-70
2118.207F-ACOT-70

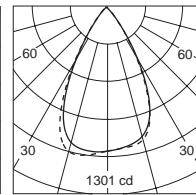
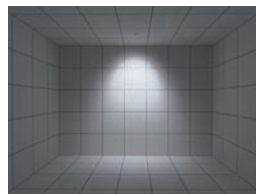

H(m)	D(m)	E(lx)
60°		
1.0	1.06	1279
2.0	2.12	319
3.0	3.18	142
4.0	4.24	79
5.0	5.30	51

EPIC-85 Round-Wallwash



EPIC-85-RTW
EPIC-85-RTLW



Colours

Bezel: Black White

Baffle: Black

Article number	LED Consumption	Current	LED Lumen	Delivered Lumen	Beam Angle	CCT	CRI
Trim							
 2118.108-ACOT-70	12W	350 mA	1446 lm	654 lm	Wallwash (Lens)	3000K	90+
2118.108-ACOT-70-WCW	13W	350 mA	1143-1356 lm	-	Wallwash (Lens)	2700-6500K	90+
Trimless							
 2118.208F-ACOT-70	12W	350 mA	1446 lm	654 lm	Wallwash (Lens)	3000K	90+
2118.208F-ACOT-70-WCW	13W	350 mA	1143-1356 lm	-	Wallwash (Lens)	2700-6500K	90+

* Wallwash lens — best optical matching angle: 15°

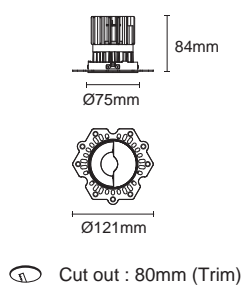
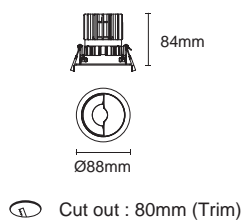

Dimmable



IES



Wallwash

2118.108-ACOT-70
2118.208F-ACOT-70

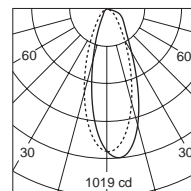
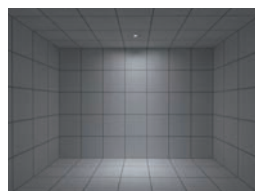

H(m)	D(m)	E(lx)
Wallwash		
1.0	0.63	1012
2.0	1.27	253
3.0	1.90	112
4.0	2.54	63
5.0	3.17	40





EPIC-85 Square-Fixed

EPIC-85-STF
EPIC-85-STLF



Colours

Bezel: Black White
 Baffle: Black White
 Haze: Gold

Article number	LED Consumption	Current	LED Lumen	Delivered Lumen	Beam Angle	CCT	CRI
Trim							
 2118.109-ACOT-70A	10W	800 mA	774 lm	-	10° (Lens)	3000K	90+
2118.109-ACOT-70	12W	350 mA	1446 lm	1172 lm	30°/50°/60° (Lens)	3000K	90+
2118.109-ACOT-70-WCW	13W	350 mA	1143-1356 lm	-	30°/50°/60° (Lens)	2700-6500K	90+
Trimless							
 2118.209A-ACOT-70A	10W	800 mA	774 lm	-	10° (Lens)	3000K	90+
2118.209A-ACOT-70	12W	350 mA	1446 lm	1172 lm	30°/50°/60° (Lens)	3000K	90+
2118.209A-ACOT-70-WCW	13W	350 mA	1143-1356 lm	-	30°/50°/60° (Lens)	2700-6500K	90+

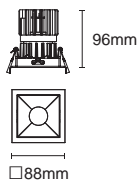

 Cut out : 80x80mm (Trim)

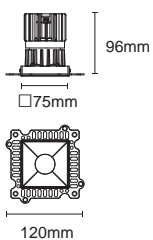

 Cut out : 80x80mm (Trimless)

Dimmable



Optional Accessory



ACSC-4 Striped glass ACHO-5 Honeycomb louver ACDS-4 Diffusion sheet ACWG-5 Woven glass ACOT-108 Suction cup

 **30°**

Fixed UGR<13

2118.109-ACOT-70
2118.209A-ACOT-70

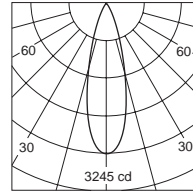
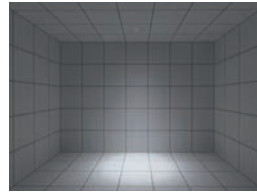

H(m)	D(m)	E(lx)
30°		
1.0	0.51	3246
2.0	1.02	811
3.0	1.53	360
4.0	2.04	202
5.0	2.55	129

 **50°**

Fixed UGR<16

2118.109-ACOT-70
2118.209A-ACOT-70

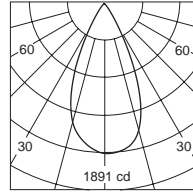
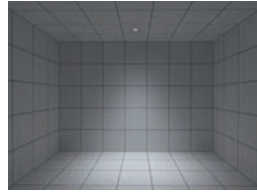

H(m)	D(m)	E(lx)
50°		
1.0	0.88	1889
2.0	1.76	472
3.0	2.64	209
4.0	3.52	118
5.0	4.40	75

 **60°**

Fixed UGR<19

2118.109-ACOT-70
2118.209A-ACOT-70

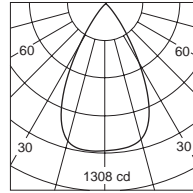
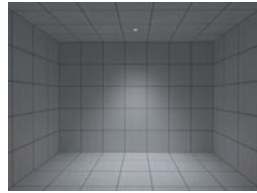

H(m)	D(m)	E(lx)
60°		
1.0	1.09	1289
2.0	2.18	322
3.0	3.26	143
4.0	4.35	80
5.0	5.44	51

EPIC-85 Square-Adjustable

EPIC-85-STA
EPIC-85-STLA



Colours

- Bezel: Black White
 Baffle: Black White
 Haze: Gold

Article number	LED Consumption	Current	LED Lumen	Delivered Lumen	Beam Angle	CCT	CRI
Trim							
 2118.110-ACOT-70A	10W	800 mA	774 lm	-	10° (Lens)	3000K	90+
2118.110-ACOT-70	12W	350 mA	1446 lm	1135 lm	30°/50°/60° (Lens)	3000K	90+
2118.110-ACOT-70-WCW	13W	350 mA	1143-1356 lm	-	30°/50°/60° (Lens)	2700-6500K	90+
Trimless							
 2118.210A-ACOT-70A	10W	800 mA	774 lm	-	10° (Lens)	3000K	90+
2118.210A-ACOT-70	12W	350 mA	1446 lm	1135 lm	30°/50°/60° (Lens)	3000K	90+
2118.210A-ACOT-70-WCW	13W	350 mA	1143-1356 lm	-	30°/50°/60° (Lens)	2700-6500K	90+

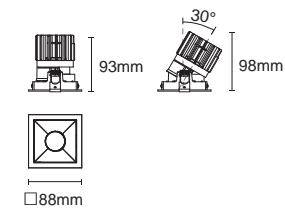

 Cut out : 80x80mm (Trim)

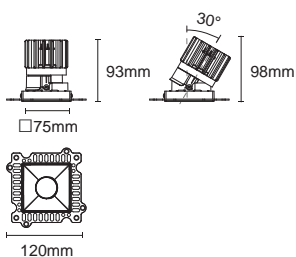

 Cut out : 80x80mm (Trimless)

Dimmable



Optional Accessory

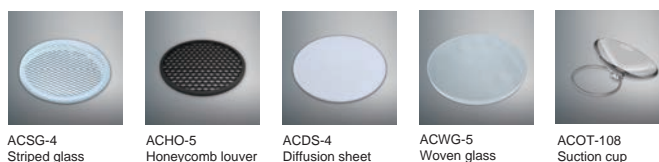

ACSG-4
Striped glass

ACHO-5
Honeycomb louver

ACDS-4
Diffusion sheet

ACWG-5
Woven glass

ACOT-108
Suction cup

 30°

Adjustable
 2118.110-ACOT-70
 2118.210A-ACOT-70

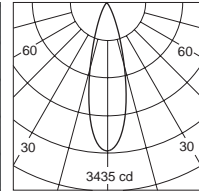
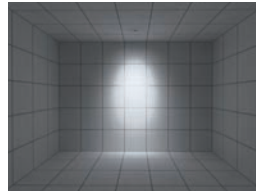

H(m)	D(m)	E(lx)
30°		
1.0	0.49	3438
2.0	0.98	859
3.0	1.48	382
4.0	1.97	214
5.0	2.46	137

 50°

Adjustable
 2118.110-ACOT-70
 2118.210A-ACOT-70

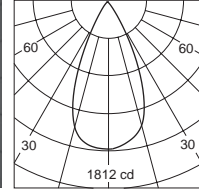
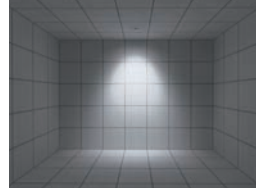

H(m)	D(m)	E(lx)
50°		
1.0	0.89	1812
2.0	1.79	453
3.0	2.68	201
4.0	3.57	113
5.0	4.46	72

 60°

Adjustable
 2118.110-ACOT-70
 2118.210A-ACOT-70

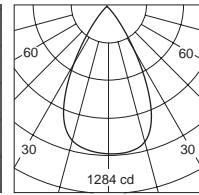
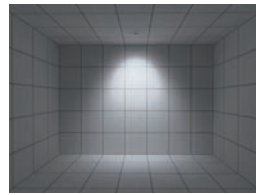

H(m)	D(m)	E(lx)
60°		
1.0	1.08	1263
2.0	2.16	315
3.0	3.24	140
4.0	4.32	78
5.0	5.40	50

EPIC-85 Square-Wallwash



EPIC-85-STW
EPIC-85-STLW



Colours

Bezel : Black White

Baffle : Black

Article number	LED Consumption	Current	LED Lumen	Delivered Lumen	Beam Angle	CCT	CRI
Trim							
 2118.111-ACOT-70	12W	350 mA	1446 lm	627 lm	Wallwash (Lens)	3000K	90+
2118.111-ACOT-70-WCW	13W	350 mA	1143-1356 lm	-	Wallwash (Lens)	2700-6500K	90+
Trimless							
 2118.211A-ACOT-70	12W	350 mA	1446 lm	627 lm	Wallwash (Lens)	3000K	90+
2118.211A-ACOT-70-WCW	13W	350 mA	11143-1356 lm	-	Wallwash (Lens)	2700-6500K	90+

* Wallwash lens – best optical matching angle: 15°

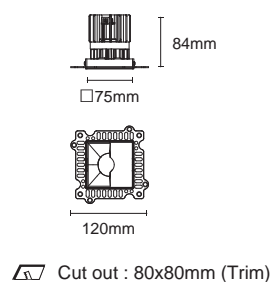
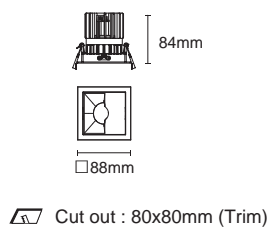

Dimmable



IES



Wallwash

2118.111-ACOT-70
2118.211A-ACOT-70

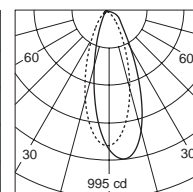
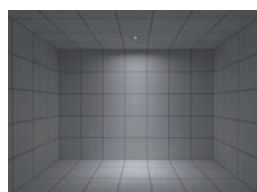

H(m)	D(m)	E lx)
Wallwash		
1.0	0.63	995
2.0	1.26	248
3.0	1.89	110
4.0	2.52	62
5.0	3.15	39





EPIC-110 ▶

Round / Square

Fixed
Adjustable
wallwash

EPIC-110 Round-Fixed

EPIC-110-RTF
EPIC-110-RTLF



Colours

Bezel : Black White

Baffle : Black White

Haze Gold Chrome

Article number	LED Consumption	Current	LED Lumen	Delivered Lumen	Beam Angle	CCT	CRI
Trim							
 2018.187-LEE-15A	13W	350 mA	1182 lm	-	10° (Lens)	3000K	90+
2018.187-LEE-15	17W	500 mA	2004 lm	1697 lm	20°/30°/45°/55°/65° (Lens)	3000K	90+
2018.187-LEE-15-DW	16W	450 mA	34-1507 lm	1200 lm	20°/25°/40°/50° (Lens)	1800-3000K	90+
 2018.187-ACOT-72	25W	700 mA	2873 lm	2255 lm	30°/40°/50°/60° (Lens)	3000K	90+
2018.187-ACOT-72-WCW	22W	600 mA	2086-2304 lm	-	30°/40°/50°/60° (Lens)	2700-6500K	90+
Trimless							
 2018.259F-LEE-15A	13W	350 mA	1182 lm	-	10° (Lens)	3000K	90+
2018.259F-LEE-15	17W	500 mA	2004lm	1697 lm	20°/30°/45°/55°/65° (Lens)	3000K	90+
2018.259F-LEE-15-DW	16W	450 mA	34-1507 lm	1200 lm	20°/25°/40°/50° (Lens)	1800-3000K	90+
 2018.259F-ACOT-72	25W	700 mA	2873 lm	2255 lm	30°/40°/50°/60° (Lens)	3000K	90+
2018.259F-ACOT-72-WCW	22W	600 mA	2086-2304 lm	-	30°/40°/50°/60° (Lens)	2700-6500K	90+

2018.187-LEE-15
2018.187-LEE-15A
2018.187-LEE-15-DW



⌀ Cut out : 100mm (Trim)

Dimmable



Optional Accessory



SG7-1 Striped glass H7-1 Honeycomb louver DS7-1 Diffusion sheet WG7-1 Woven glass ACOT-109 Suction cup



ACOT-82 MR16 Accessory kits ACOT-83 GU10 Accessory kits PJ-0079 MR16&GU10 Accessory

2018.187-ACOT-72
2018.187-ACOT-72-WCW

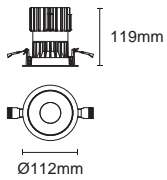

⊖ Cut out : 100mm (Trim)

2018.259F-LEE-15
2018.259F-LEE-15A
2018.259F-LEE-15-DW

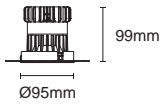

⊖ Cut out : 100mm (Trimless)

2018.259F-ACOT-72
2018.259F-ACOT-72-WCW

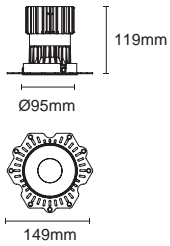

⊖ Cut out : 100mm (Trimless)

IES

 20°

Fixed UGR<10

2018.187-LEE-15
2018.259F-LEE-15

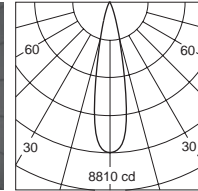
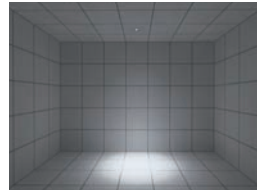

H(m)	D(m)	E(lx)
20°		
1.0	0.38	8808
2.0	0.77	2202
3.0	1.15	978
4.0	1.53	550
5.0	1.91	352

 30°

Fixed UGR<10

2018.187-LEE-15
2018.259F-LEE-15

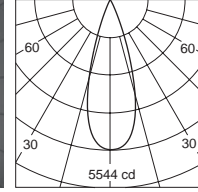
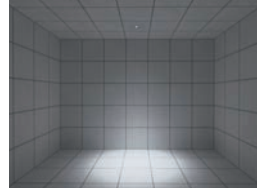

H(m)	D(m)	E(lx)
30°		
1.0	0.59	5545
2.0	1.18	1386
3.0	1.77	616
4.0	2.35	346
5.0	2.94	221

 45°

Fixed UGR<13

2018.187-LEE-15
2018.259F-LEE-15

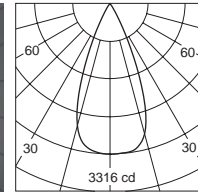
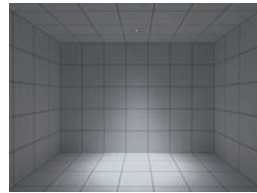

H(m)	D(m)	E(lx)
45°		
1.0	0.79	3325
2.0	1.58	831
3.0	2.37	369
4.0	3.16	207
5.0	3.94	133

 55°

Fixed UGR<19

2018.187-LEE-15
2018.259F-LEE-15

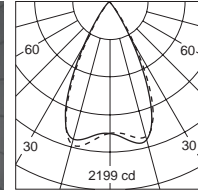
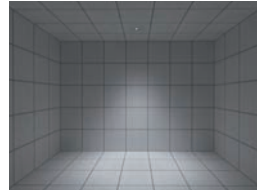

H(m)	D(m)	E(lx)
55°		
1.0	1.05	2051
2.0	2.11	512
3.0	3.16	227
4.0	4.22	128
5.0	5.27	82

 30°

Fixed UGR<16

2018.187-ACOT-72
2018.259F-ACOT-72

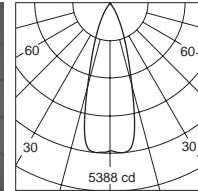
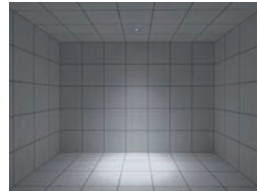

H(m)	D(m)	E(lx)
30°		
1.0	0.58	5365
2.0	1.15	1341
3.0	1.73	596
4.0	2.31	335
5.0	2.88	214

 40°

Fixed UGR<16

2018.187-ACOT-72
2018.259F-ACOT-72

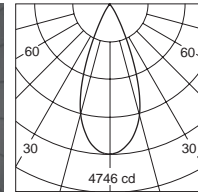
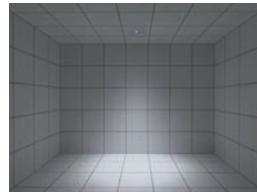

H(m)	D(m)	E(lx)
40°		
1.0	0.74	4751
2.0	1.49	1188
3.0	2.23	527
4.0	2.98	296
5.0	3.72	190

 50°

Fixed UGR<19

2018.187-ACOT-72
2018.259F-ACOT-72

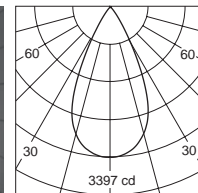
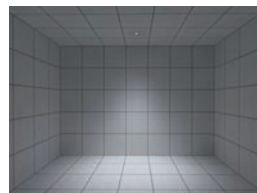

H(m)	D(m)	E(lx)
50°		
1.0	0.94	3396
2.0	1.87	848
3.0	2.81	377
4.0	3.75	212
5.0	4.68	135

 60°

Fixed UGR<22

2018.187-ACOT-72
2018.259F-ACOT-72

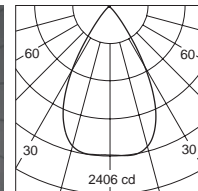
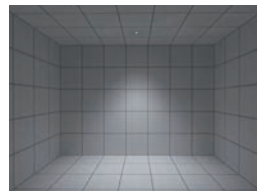

H(m)	D(m)	E(lx)
60°		
1.0	1.15	2381
2.0	2.31	595
3.0	3.46	264
4.0	4.62	148
5.0	5.77	95

EPIC-110 Round-Adjustable

EPIC-110-RTA
EPIC-110-RTL



Colours

Bezel : Black White

Baffle : Black White

Haze Gold Chrome

Article number	LED Consumption	Current	LED Lumen	Delivered Lumen	Beam Angle	CCT	CRI
Trim							
 2018.191-LEE-15A	13W	350 mA	1182 lm	-	10° (Lens)	3000K	90+
2018.191-LEE-15	17W	500 mA	2004 lm	1702 lm	20°/30°/45°/55°/65° (Lens)	3000K	90+
2018.191-LEE-15-DW	16W	450 mA	34-1507 lm	1200 lm	20°/25°/40°/50° (Lens)	1800-3000K	90+
 2018.191-ACOT-72	25W	700 mA	2873 lm	2207 lm	30°/40°/50°/60° (Lens)	3000K	90+
2018.191-ACOT-72-WCW	22W	600 mA	2086-2304 lm	-	30°/40°/50°/60° (Lens)	2700-6500K	90+
Trimless							
 2018.260F-LEE-15A	13W	350 mA	1182 lm	-	10° (Lens)	3000K	90+
2018.260F-LEE-15	17W	500 mA	2004 lm	1702 lm	20°/30°/45°/55°/65° (Lens)	3000K	90+
2018.260F-LEE-15-DW	16W	450 mA	34-1507 lm	1200 lm	20°/25°/40°/50° (Lens)	1800-3000K	90+
 2018.260F-ACOT-72	25W	700 mA	2873 lm	2207 lm	30°/40°/50°/60° (Lens)	3000K	90+
2018.260F-ACOT-72-WCW	22W	600 mA	2086-2304 lm	-	30°/40°/50°/60° (Lens)	2700-6500K	90+

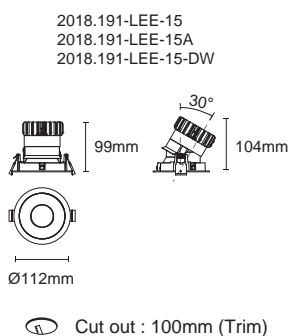

Dimmable



Optional Accessory



2018.191-ACOT-72
2018.191-ACOT-72-WCW

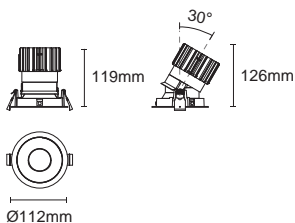

Cut out : 100mm (Trim)

2018.260F-LEE-15
2018.260F-LEE-15A
2018.260F-LEE-15-DW

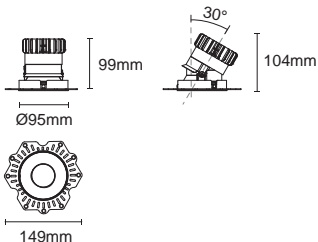

Cut out : 100mm (Trimless)

2018.260F-ACOT-72
2018.260F-ACOT-72-WCW

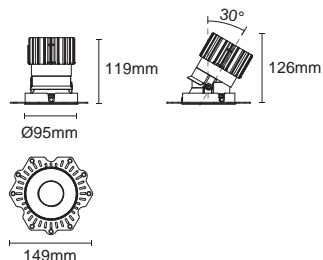

Cut out : 100mm (Trimless)

IES

20°

Adjustable

2018.191-LEE-15
2018.260F-LEE-15

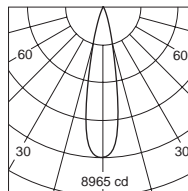
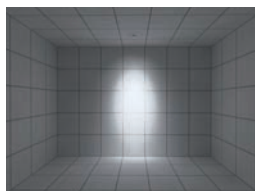

H(m)	D(m)	E(lx)
20°		
1.0	0.38	8971
2.0	0.77	2243
3.0	1.15	996
4.0	1.53	560
5.0	1.92	358

30°

Adjustable

2018.191-LEE-15
2018.260F-LEE-15

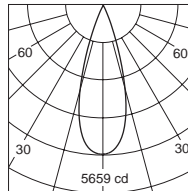
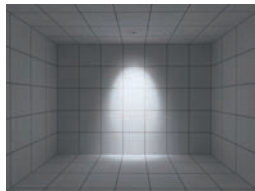

H(m)	D(m)	E(lx)
30°		
1.0	0.58	5663
2.0	1.17	1416
3.0	1.75	629
4.0	2.34	353
5.0	2.92	226

45°

Adjustable

2018.191-LEE-15
2018.260F-LEE-15

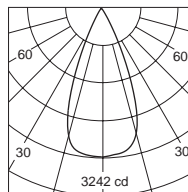
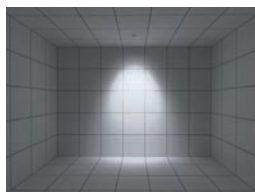

H(m)	D(m)	E(lx)
45°		
1.0	0.80	3234
2.0	1.60	808
3.0	2.40	359
4.0	3.20	202
5.0	4.00	129

55°

Adjustable

2018.191-LEE-15
2018.260F-LEE-15

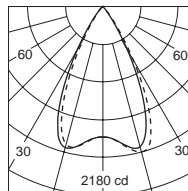
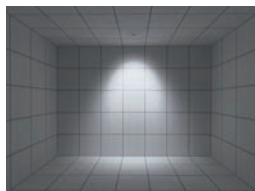

H(m)	D(m)	E(lx)
55°		
1.0	1.07	1995
2.0	2.14	498
3.0	3.21	221
4.0	4.28	124
5.0	5.35	79

30°

Adjustable

2018.191-ACOT-72
2018.260F-ACOT-72

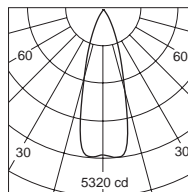
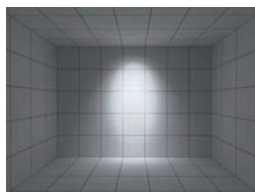

H(m)	D(m)	E(lx)
30°		
1.0	0.55	5265
2.0	1.10	1316
3.0	1.65	585
4.0	2.20	329
5.0	2.75	210

40°

Adjustable

2018.191-ACOT-72
2018.260F-ACOT-72

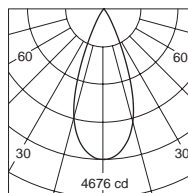
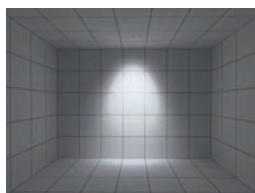

H(m)	D(m)	E(lx)
40°		
1.0	0.74	4677
2.0	1.47	1169
3.0	2.21	519
4.0	2.95	292
5.0	3.68	187

50°

Adjustable

2018.191-ACOT-72
2018.260F-ACOT-72

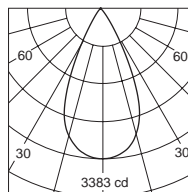
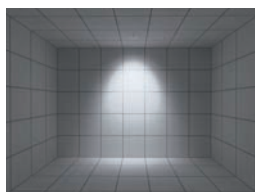

H(m)	D(m)	E(lx)
50°		
1.0	0.92	3378
2.0	1.84	844
3.0	2.76	375
4.0	3.68	211
5.0	4.61	135

60°

Adjustable

2018.191-ACOT-72
2018.260F-ACOT-72

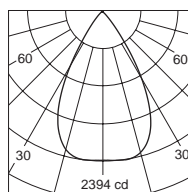
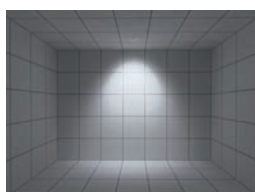

H(m)	D(m)	E(lx)
60°		
1.0	1.13	2374
2.0	2.26	593
3.0	3.39	263
4.0	4.52	148
5.0	5.65	94

EPIC-110 Round-Wallwash

EPIC-110-RTW
EPIC-110-RTLW



Colours

Bezel : Black White

Baffle : Black

Article number	LED Consumption	Current	LED Lumen	Delivered Lumen	Beam Angle	CCT	CRI
Trim							
 2018.192-LEE-15	17W	500 mA	2004 lm	1100 lm	Wallwash (Lens)	3000K	90+
2018.192-LEE-15-DW	16W	450 mA	34-1507 lm	713 lm	Wallwash (Lens)	1800-3000K	90+
 2018.192-ACOT-72	25W	700 mA	2873 lm	1385 lm	Wallwash (Lens)	3000K	90+
2018.192-ACOT-72-WCW	22W	600 mA	2086-2304 lm	-	Wallwash (Lens)	2700-6500K	90+
Trimless							
 2018.261F-LEE-15	17W	500 mA	2004 lm	1100 lm	Wallwash (Lens)	3000K	90+
2018.261F-LEE-15-DW	16W	450 mA	34-1507 lm	713 lm	Wallwash (Lens)	1800-3000K	90+
 2018.261F-ACOT-72	25W	700 mA	2873 lm	1385 lm	Wallwash (Lens)	3000K	90+
2018.261F-ACOT-72-WCW	22W	600 mA	2086-2304 lm	-	Wallwash (Lens)	2700-6500K	90+

* Wallwash lens — best optical matching angle: 36°

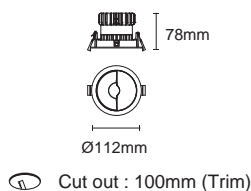

○ Cut out : 100mm (Trim)

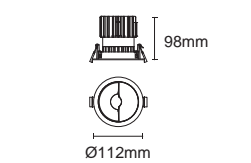

○ Cut out : 100mm (Trim)

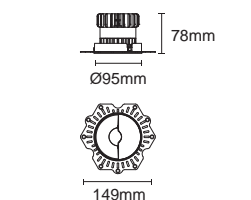

○ Cut out : 100mm (Trimless)

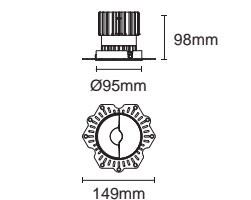

○ Cut out : 100mm (Trimless)

Dimmable



IES



Wallwash

2018.192-LEE-15
2018.261F-LEE-15

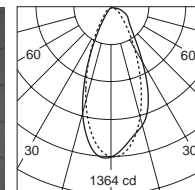
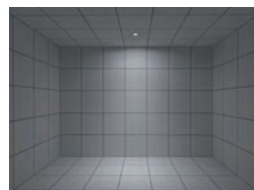

H(m)	D(m)	E(lx)
Wallwash		
1.0	0.77	1360
2.0	1.54	340
3.0	2.32	151
4.0	3.09	85
5.0	3.86	54



Wallwash

2018.192-ACOT-72
2018.261F-ACOT-72

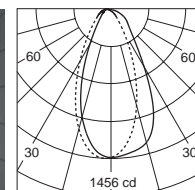
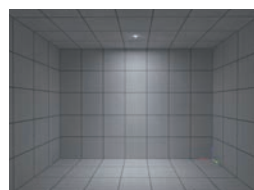

H(m)	D(m)	E(lx)
Wallwash		
1.0	0.85	1455
2.0	1.17	363
3.0	2.56	161
4.0	3.41	90
5.0	4.27	58



EPIC-110 Square-Fixed

EPIC-110-STF
EPIC-110-STLF



Colours

Bezel : Black White

Baffle : Black White

Haze Gold Chrome

Article number	LED Consumption	Current	LED Lumen	Delivered Lumen	Beam Angle	CCT	CRI
Trim							
 2018.188-LEE-15A	13W	350 mA	1182 lm	-	10° (Lens)	3000K	90+
2018.188-LEE-15	17W	500 mA	2004 lm	1639 lm	20°/30°/45°/55°/65° (Lens)	3000K	90+
2018.188-LEE-15-DW	16W	450 mA	34-1507 lm	1212 lm	20°/25°/40°/50° (Lens)	1800-3000K	90+
 2018.188-ACOT-72	25W	700 mA	2873 lm	2239 lm	30°/40°/50°/60° (Lens)	3000K	90+
2018.188-ACOT-72-WCW	22W	600 mA	2086-2304 lm	-	30°/40°/50°/60° (Lens)	2700K-6500K	90+
Trimless							
 2018.264A-LEE-15A	13W	350 mA	1182 lm	-	10° (Lens)	3000K	90+
2018.264A-LEE-15	17W	500 mA	2004lm	1639 lm	20°/30°/45°/55°/65° (Lens)	3000K	90+
2018.264A-LEE-15-DW	16W	450 mA	34-1507 lm	1212 lm	20°/25°/40°/50° (Lens)	1800-3000K	90+
 2018.264A-ACOT-72	25W	700 mA	2873 lm	2239 lm	30°/40°/50°/60° (Lens)	3000K	90+
2018.264A-ACOT-72-WCW	22W	600 mA	2086-2304 lm	-	30°/40°/50°/60° (Lens)	2700K-6500K	90+

2018.188-LEE-15
2018.188-LEE-15A
2018.188-LEE-15-DW



 Cut out : 100x100mm (Trim)

Dimmable



Optional Accessory



SG7-1 Striped glass H7-1 Honeycomb louver DS7-1 Diffusion sheet WG7-1 Woven glass ACOT-109 Suction cup



ACOT-82 MR16 Accessory kits ACOT-83 GU10 Accessory kits PJ-0079 MR16&GU10 Accessory

2018.188-ACOT-72
2018.188-ACOT-72-WCW

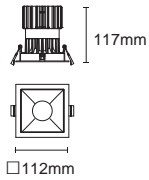

Cut out : 100x100mm (Trim)

2018.264A-LEE-15
2018.264A-LEE-15A
2018.264A-LEE-15-DW

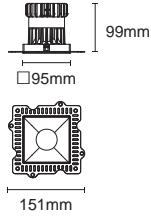

Cut out : 100x100mm (Trimless)

2018.264A-ACOT-72
2018.264A-ACOT-72-WCW

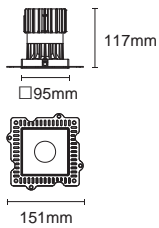

Cut out : 100x100mm (Trimless)

IES

20°

Fixed UGR<10

2018.188-LEE-15
2018.264A-LEE-15

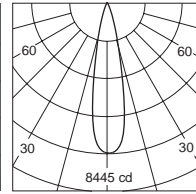
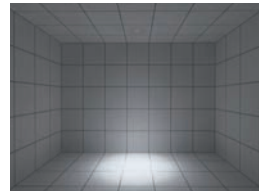

H(m)	D(m)	E(lx)
20°		
1.0	0.38	8437
2.0	0.77	2109
3.0	1.15	937
4.0	1.53	527
5.0	1.92	337

30°

Fixed UGR<10

2018.188-LEE-15
2018.264A-LEE-15

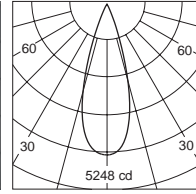
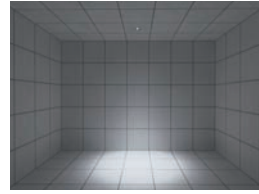

H(m)	D(m)	E(lx)
30°		
1.0	0.59	5246
2.0	1.17	1312
3.0	1.76	582
4.0	2.34	327
5.0	2.93	209

45°

Fixed UGR<13

2018.188-LEE-15
2018.264A-LEE-15

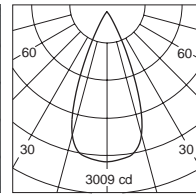
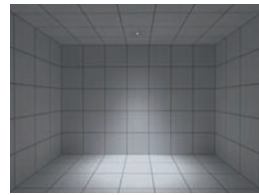

H(m)	D(m)	E(lx)
45°		
1.0	0.82	2999
2.0	1.63	749
3.0	2.45	333
4.0	3.26	187
5.0	4.08	120

55°

Fixed UGR<16

2018.188-LEE-15
2018.264A-LEE-15

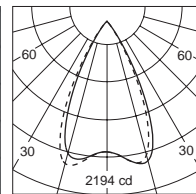
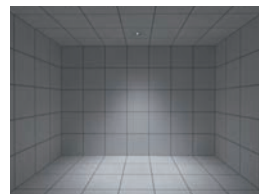

H(m)	D(m)	E(lx)
55°		
1.0	1.06	2014
2.0	2.12	503
3.0	3.18	223
4.0	4.25	125
5.0	5.31	80

30°

Fixed UGR<10

2018.188-ACOT-72
2018.264A-ACOT-72

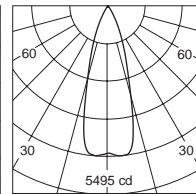
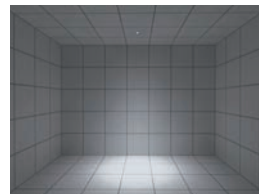

H(m)	D(m)	E(lx)
30°		
1.0	0.57	5456
2.0	1.13	1364
3.0	1.70	606
4.0	2.27	341
5.0	2.84	218

40°

Fixed UGR<10

2018.188-ACOT-72
2018.264A-ACOT-72

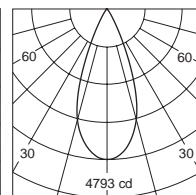
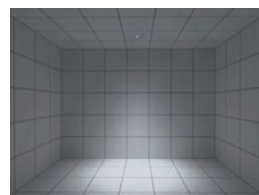

H(m)	D(m)	E(lx)
40°		
1.0	0.74	4794
2.0	1.49	1199
3.0	2.23	532
4.0	2.98	299
5.0	3.72	191

50°

Fixed UGR<13

2018.188-ACOT-72
2018.264A-ACOT-72

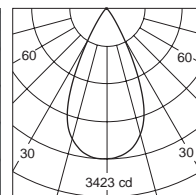
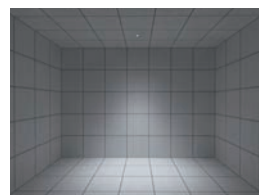

H(m)	D(m)	E(lx)
50°		
1.0	0.93	3425
2.0	1.85	856
3.0	2.78	380
4.0	3.71	214
5.0	4.64	137

60°

Fixed UGR<16

2018.188-ACOT-72
2018.264A-ACOT-72

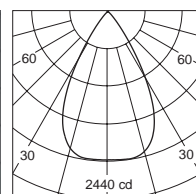
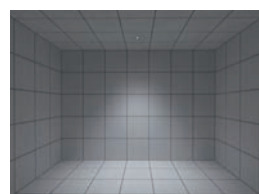

H(m)	D(m)	E(lx)
60°		
1.0	1.13	2409
2.0	2.25	602
3.0	3.38	267
4.0	4.50	150
5.0	5.63	96

EPIC-110 Square-Adjustable

EPIC-110-STA
EPIC-110-STLA



Colours

Bezel : Black White

Baffle : Black White

Haze Gold Chrome

Article number	LED Consumption	Current	LED Lumen	Delivered Lumen	Beam Angle	CCT	CRI
Trim							
 2018.195-LEE-15A	13W	350 mA	1182 lm	-	10° (Lens)	3000K	90+
2018.195-LEE-15	17W	500 mA	2004 lm	1616 lm	20°/30°/45°/55°/65° (Lens)	3000K	90+
2018.195-LEE-15-DW	16W	450 mA	34-1507 lm	1227 lm	20°/25°/40°/50° (Lens)	1800-3000K	90+
 2018.195-ACOT-72	25W	700 mA	2873 lm	2208 lm	30°/40°/50°/60° (Lens)	3000K	90+
2018.195-ACOT-72-WCW	22W	600 mA	2086-2304 lm	-	30°/40°/50°/60° (Lens)	2700K-6500K	90+
Trimless							
 2018.265A-LEE-15A	13W	350 mA	1182 lm	-	10° (Lens)	3000K	90+
2018.265A-LEE-15	17W	500 mA	2004 lm	1616 lm	20°/30°/45°/55°/65° (Lens)	3000K	90+
2018.265A-LEE-15-DW	16W	450 mA	34-1507 lm	1227 lm	20°/25°/40°/50° (Lens)	1800-3000K	90+
 2018.265A-ACOT-72	25W	700 mA	2873 lm	2208 lm	30°/40°/50°/60° (Lens)	3000K	90+
2018.265A-ACOT-72-WCW	22W	600 mA	2086-2304 lm	-	30°/40°/50°/60° (Lens)	2700K-6500K	90+

2018.195-LEE-15
2018.195-LEE-15A
2018.195-LEE-15-DW

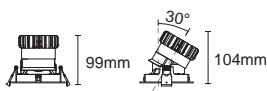

 Cut out : 100x100mm (Trim)

Dimmable



Optional Accessory



SG7-1
Striped glass



H7-1
Honeycomb louver



DS7-1
Diffusion sheet



WG7-1
Woven glass



ACOT-109
Suction cup



ACOT-82
MR16 Accessory kits



ACOT-83
GU10 Accessory kits



PJ-0079
MR16&GU10 Accessory

2018.195-ACOT-72
2018.195-ACOT-72-WCW

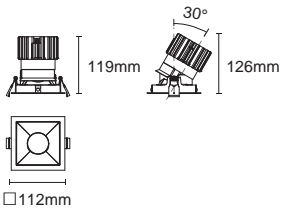

Cut out : 100x100mm (Trim)

2018.265A-LEE-15
2018.265A-LEE-15A
2018.265A-LEE-15-DW

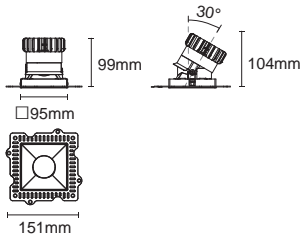

Cut out : 100x100mm (Trimless)

2018.265A-ACOT-72
2018.265A-ACOT-72-WCW

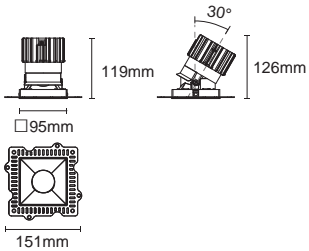

Cut out : 100x100mm (Trimless)

IES

20°

Adjustable

2018.195-LEE-15
2018.265A-LEE-15

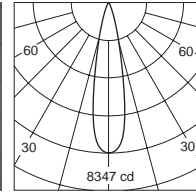
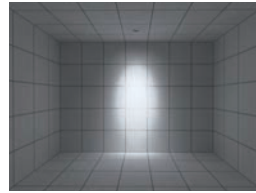

H(m)	D(m)	E(lx)
20°		
1.0	0.38	8345
2.0	0.77	2086
3.0	1.15	927
4.0	1.53	521
5.0	1.91	333

30°

Adjustable

2018.195-LEE-15
2018.265A-LEE-15

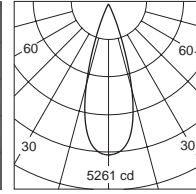
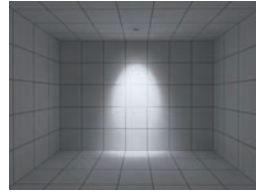

H(m)	D(m)	E(lx)
30°		
1.0	0.59	5262
2.0	1.18	1316
3.0	1.77	584
4.0	2.36	328
5.0	2.95	210

45°

Adjustable

2018.195-LEE-15
2018.265A-LEE-15

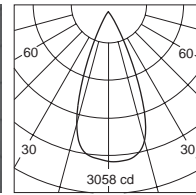
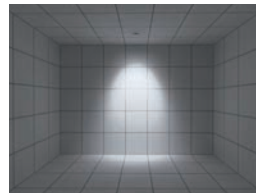

H(m)	D(m)	E(lx)
45°		
1.0	0.80	3044
2.0	1.60	761
3.0	2.40	338
4.0	3.20	190
5.0	4.01	121

55°

Adjustable

2018.195-LEE-15
2018.265A-LEE-15

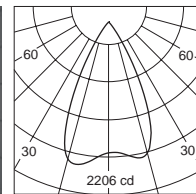
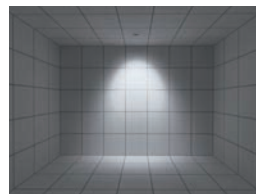

H(m)	D(m)	E(lx)
55°		
1.0	1.05	2042
2.0	2.10	510
3.0	3.15	226
4.0	4.20	127
5.0	5.25	81

30°

Adjustable

2018.195-ACOT-72
2018.265A-ACOT-72

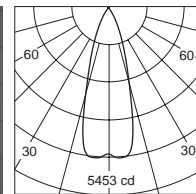
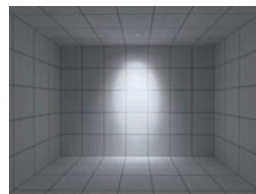

H(m)	D(m)	E(lx)
30°		
1.0	0.56	5402
2.0	1.12	1351
3.0	1.68	600
4.0	2.24	337
5.0	2.80	216

40°

Adjustable

2018.195-ACOT-72
2018.265A-ACOT-72

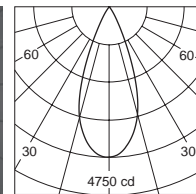
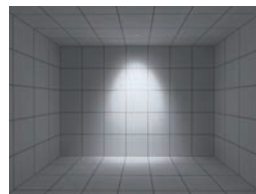

H(m)	D(m)	E(lx)
40°		
1.0	0.74	4744
2.0	1.48	1186
3.0	2.22	527
4.0	2.96	296
5.0	3.71	189

50°

Adjustable

2018.195-ACOT-72
2018.265A-ACOT-72

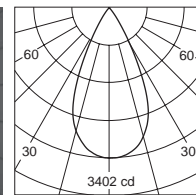
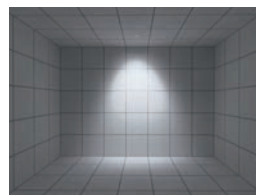

H(m)	D(m)	E(lx)
50°		
1.0	0.93	3398
2.0	1.86	849
3.0	2.78	377
4.0	3.71	212
5.0	4.64	135

60°

Adjustable

2018.195-ACOT-72
2018.265A-ACOT-72

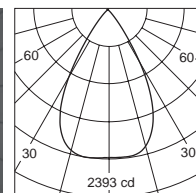
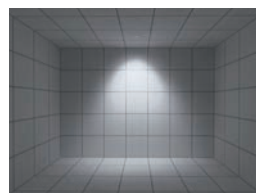

H(m)	D(m)	E(lx)
60°		
1.0	1.13	2373
2.0	2.27	593
3.0	3.40	263
4.0	4.54	148
5.0	5.67	94

EPIC-110 Square-Wallwash

EPIC-110-STW
EPIC-110-STLW



Colours

Bezel : Black White

Baffle : Black

Article number	LED Consumption	Current	LED Lumen	Delivered Lumen	Beam Angle	CCT	CRI
Trim							
2018.196-LEE-15	17W	500 mA	2004 lm	1062 lm	Wallwash (Lens)	3000K	90+
2018.196-LEE-15-DW	16W	450 mA	34-1507 lm	739 lm	Wallwash (Lens)	1800-3000K	90+
2018.196-ACOT-72	25W	700 mA	2873 lm	1396 lm	Wallwash (Lens)	3000K	90+
2018.196-ACOT-72-WCW	22W	600 mA	2086-2304 lm	-	Wallwash (Lens)	2700K-6500K	90+
Trimless							
2018.266A-LEE-15	17W	500 mA	2004 lm	1062 lm	Wallwash (Lens)	3000K	90+
2018.266A-LEE-15-DW	16W	450 mA	34-1507 lm	739 lm	Wallwash (Lens)	1800-3000K	90+
2018.266A-ACOT-72	25W	700 mA	2873 lm	1396 lm	Wallwash (Lens)	3000K	90+
2018.266A-ACOT-72-WCW	22W	600 mA	2086-2304 lm	-	Wallwash (Lens)	2700K-6500K	90+

* Wallwash lens — best optical matching angle: 36°

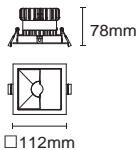

Cut out : 100x100mm (Trim)

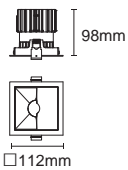

Cut out : 100x100mm (Trim)

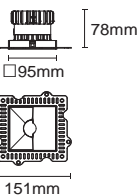

Cut out : 100x100mm (Trimless)

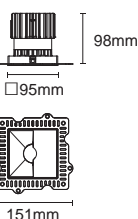

Cut out : 100x100mm (Trimless)

Dimmable



IES



Wallwash

2018.196-LEE-15
2018.266A-LEE-15

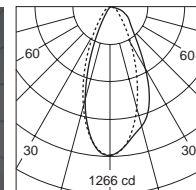
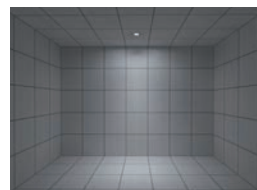

H(m)	D(m)	E(lx)
Wallwash		
1.0	0.78	1264
2.0	1.56	316
3.0	2.34	140
4.0	3.12	79
5.0	3.90	50



Wallwash

2018.196-ACOT-72
2018.266A-ACOT-72

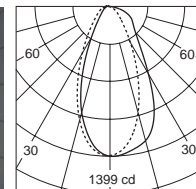
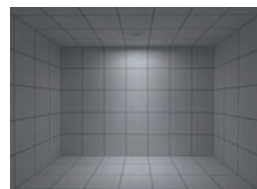

H(m)	D(m)	E(lx)
Wallwash		
1.0	0.86	1399
2.0	1.72	349
3.0	2.59	155
4.0	3.45	87
5.0	4.31	55





EPIC-135 ▶

Round / Square

Fixed
Adjustable
wallwash

EPIC-135 Round-Fixed

EPIC-135-RTF
EPIC-135-RTLF



Colours

- Bezel : Black White
 Baffle : Black White
 Haze Gold Chrome

Article number	Fixture Consumption	Current	LED Lumen	Delivered Lumen	Beam Angle	CCT	CRI
Trim							
2018.464-ACOT-73	32W	900 mA	3667 lm	3187 lm	20°/30°/45°/55°/70° (Lens)	3000K	90+
2018.464-ACOT-73-WCW	29W	800 mA	2816-3190 lm	-	20°/30°/45°/55°/70° (Lens)	2700K-6500K	90+
Trimless							
2018.256F-ACOT-73	32W	900 mA	3667 lm	3187 lm	20°/30°/45°/55°/70° (Lens)	3000K	90+
2018.256F-ACOT-73-WCW	29W	800 mA	2816-3190 lm	-	20°/30°/45°/55°/70° (Lens)	2700K-6500K	90+

Dimmable



Optional Accessory

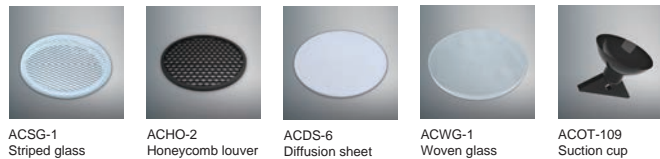

IES



20°
Fixed UGR<10
2018.464-ACOT-73
2018.256F-ACOT-73

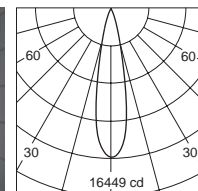
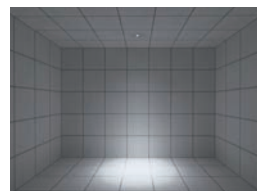

H(m)	D(m)	E(lx)
20°		
1.0	0.38	16360
2.0	0.75	4090
3.0	1.13	1818
4.0	1.51	1022
5.0	1.88	654



30°
Fixed UGR<10
2018.464-ACOT-73
2018.256F-ACOT-73

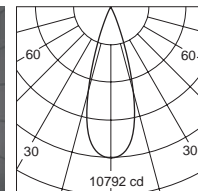
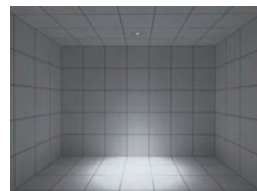

H(m)	D(m)	E(lx)
30°		
1.0	0.57	10799
2.0	1.14	2700
3.0	1.70	1200
4.0	2.27	674
5.0	2.84	432



45°
Fixed UGR<13
2018.464-ACOT-73
2018.256F-ACOT-73

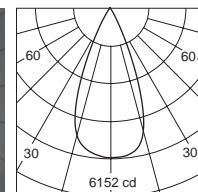
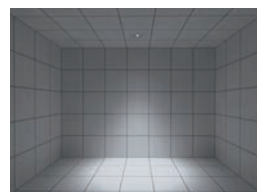

H(m)	D(m)	E(lx)
45°		
1.0	0.80	6115
2.0	1.60	1529
3.0	2.40	679
4.0	3.20	382
5.0	4.00	244



55°
Fixed UGR<16
2018.464-ACOT-73
2018.256F-ACOT-73

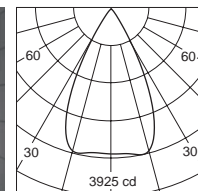
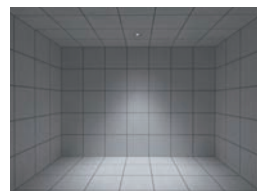

H(m)	D(m)	E(lx)
55°		
1.0	1.03	3635
2.0	2.06	908
3.0	3.10	403
4.0	4.13	227
5.0	5.16	145

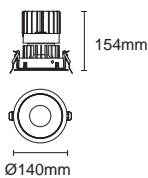

Ⓢ Cut out : 128mm (Trim)

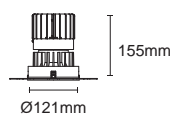

Ⓢ Cut out : 128mm (Trimless)



EPIC-135 Round-Adjustable

EPIC-135-RTA
EPIC-135-RTL



Colours

Bezel : Black White

Baffle : Black White

Haze Gold Chrome

Article number	Fixture Consumption	Current	LED Lumen	Delivered Lumen	Beam Angle	CCT	CRI
Trim							
2018.463-ACOT-73	32W	900 mA	3667 lm	3139 lm	20°/30°/45°/55°/70° (Lens)	3000K	90+
2018.463-ACOT-73-WCW	29W	800 mA	2816-3190 lm	-	20°/30°/45°/55°/70° (Lens)	2700K-6500K	90+
Trimless							
2018.255F-ACOT-73	32W	900 mA	3667 lm	3139 lm	20°/30°/45°/55°/70° (Lens)	3000K	90+
2018.255F-ACOT-73-WCW	29W	800 mA	2816-3190 lm	-	20°/30°/45°/55°/70° (Lens)	2700K-6500K	90+

Dimmable



Optional Accessory



ACSG-1
Striped glass

ACHO-2
Honeycomb louver

ACDS-6
Diffusion sheet

ACWG-1
Woven glass

ACOT-109
Suction cup

IES



Adjustable

2018.463-ACOT-73
2018.255F-ACOT-73

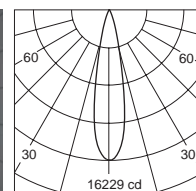
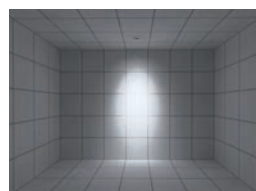

H(m)	D(m)	E(lx)
20°		
1.0	0.37	16240
2.0	0.75	4060
3.0	1.12	1804
4.0	1.49	1015
5.0	1.86	649

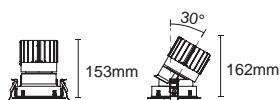

⊖ Cut out : 128mm (Trim)

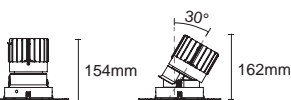

Ø121mm



⊖ Cut out : 128mm (Trimless)



Adjustable

2018.463-ACOT-73
2018.255F-ACOT-73

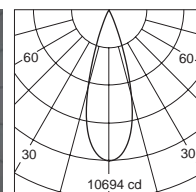
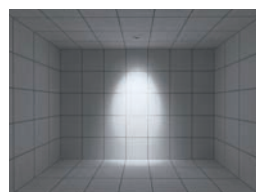

H(m)	D(m)	E(lx)
30°		
1.0	0.57	10699
2.0	1.14	2675
3.0	1.71	1189
4.0	2.28	668
5.0	2.85	428



Adjustable

2018.463-ACOT-73
2018.255F-ACOT-73

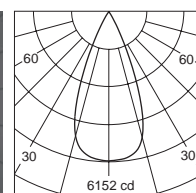
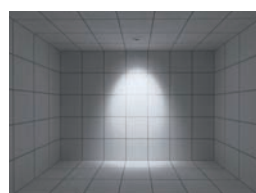

H(m)	D(m)	E(lx)
45°		
1.0	0.80	6115
2.0	1.60	1529
3.0	2.40	679
4.0	3.20	382
5.0	4.00	244



Adjustable

2018.463-ACOT-73
2018.255F-ACOT-73

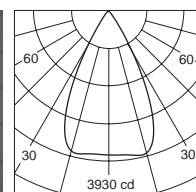
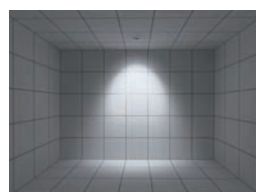

H(m)	D(m)	E(lx)
55°		
1.0	1.03	3658
2.0	2.07	914
3.0	3.10	406
4.0	4.13	228
5.0	5.16	146

EPIC-135 Round-Wallwash



EPIC-135-RTW
EPIC-135-RTLW



Colours

Bezel : Black White

Baffle : Black

Article number	Fixture Consumption	Current	LED Lumen	Delivered Lumen	Beam Angle	CCT	CRI
Trim							
 2218.146-ACOT-73	32W	900 mA	3667 lm	-	Wallwash (Lens)	3000K	90+
2218.146-ACOT-73-WCW	29W	800 mA	2816-3190 lm	-	Wallwash (Lens)	2700K-6500K	90+
Trimless							
 2218.218F-ACOT-73	32W	900 mA	3667 lm	-	Wallwash (Lens)	3000K	90+
2218.218F-ACOT-73-WCW	29W	800 mA	2816-3190 lm	-	Wallwash (Lens)	2700K-6500K	90+

* Wallwash lens — best optical matching angle: 36°

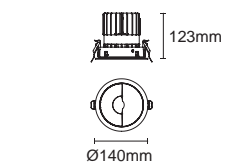

 Cut out : 128mm (Trim)

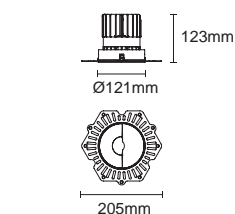

 Cut out : 128mm (Trimless)

Dimmable



B GALLERY

B GALLERY



EPIC-135 Square-Fixed

EPIC-135-STF
EPIC-135-STLF

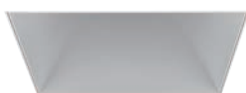

Colours

Bezel : Black White

Baffle : Black White

Haze Gold Chrome

Article number	Fixture Consumption	Current	LED Lumen	Delivered Lumen	Beam Angle	CCT	CRI
Trim							
2018.466-ACOT-73	32W	900 mA	3667 lm	3170 lm	20°/30°/45°/55°/70° (Lens)	3000K	90+
2018.466-ACOT-73-WCW	29W	800 mA	2816-3190 lm	-	20°/30°/45°/55°/70° (Lens)	2700K-6500K	90+
Trimless							
2018.258A-ACOT-73	32W	900 mA	3667 lm	3170 lm	20°/30°/45°/55°/70° (Lens)	3000K	90+
2018.258A-ACOT-73-WCW	29W	800 mA	2816-3190 lm	-	20°/30°/45°/55°/70° (Lens)	2700K-6500K	90+

Dimmable



Optional Accessory



ACSG-1
Striped glass



ACHO-2
Honeycomb louver



ACDS-6
Diffusion sheet



ACWG-1
Woven glass



ACOT-109
Suction cup

IES



Fixed UGR<10
2018.466-ACOT-73
2018.258A-ACOT-73

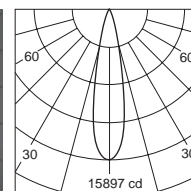
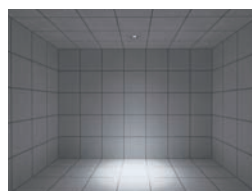

H(m)	D(m)	E(lx)
20°		
1.0	0.38	15921
2.0	0.75	3980
3.0	1.13	1769
4.0	1.51	995
5.0	1.89	636



Fixed UGR<10
2018.466-ACOT-73
2018.258A-ACOT-73

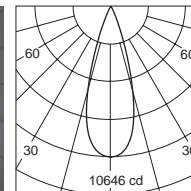
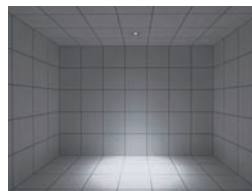

H(m)	D(m)	E(lx)
30°		
1.0	0.57	10648
2.0	1.13	2662
3.0	1.70	1183
4.0	2.26	665
5.0	2.83	425



Fixed UGR<13
2018.466-ACOT-73
2018.258A-ACOT-73

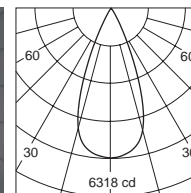
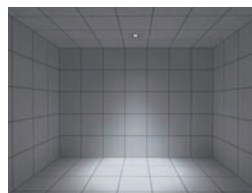

H(m)	D(m)	E(lx)
45°		
1.0	0.78	6283
2.0	1.56	1571
3.0	2.34	698
4.0	3.11	392
5.0	3.89	251



Fixed UGR<16
2018.466-ACOT-73
2018.258A-ACOT-73

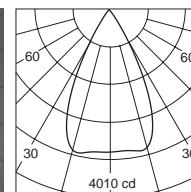
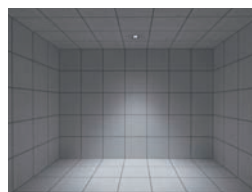

H(m)	D(m)	E(lx)
55°		
1.0	1.02	3744
2.0	2.05	935
3.0	3.07	415
4.0	4.09	234
5.0	5.12	149

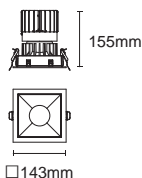

Cut out : 128x128mm (Trim)

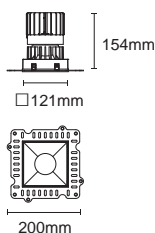

Cut out : 128x128mm (Trimless)

EPIC-135 Square-Adjustable

EPIC-135-STA
EPIC-135-STLA



Colours

Bezel : Black White

Baffle : Black White

Haze Gold Chrome

Article number	Fixture Consumption	Current	LED Lumen	Delivered Lumen	Beam Angle	CCT	CRI
Trim							
2018.465-ACOT-73	32W	900 mA	3667 lm	3121 lm	20°/30°/45°/55°/70° (Lens)	3000K	90+
2018.465-ACOT-73-WCW	29W	800 mA	2816-3190 lm	-	20°/30°/45°/55°/70° (Lens)	2700K-6500K	90+
Trimless							
2018.257A-ACOT-73	32W	900 mA	3667 lm	3121 lm	20°/30°/45°/55°/70° (Lens)	3000K	90+
2018.257A-ACOT-73-WCW	29W	800 mA	2816-3190 lm	-	20°/30°/45°/55°/70° (Lens)	2700K-6500K	90+

Dimmable



Optional Accessory



ACSG-1
Striped glass

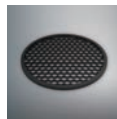

ACHO-2
Honeycomb louver



ACDS-6
Diffusion sheet

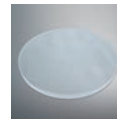

ACWG-1
Woven glass



ACOT-109
Suction cup

IES



Adjustable

2018.465-ACOT-73
2018.257A-ACOT-73

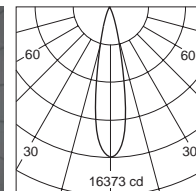
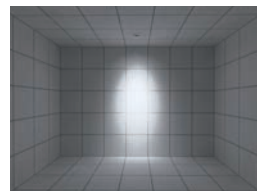

H(m)	D(m)	E(lx)
20°		
1.0	0.37	16417
2.0	0.74	4104
3.0	1.12	1824
4.0	1.49	1026
5.0	1.86	656



Adjustable

2018.465-ACOT-73
2018.257A-ACOT-73

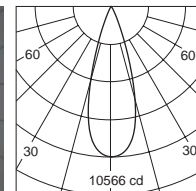
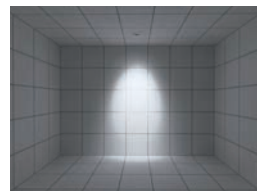

H(m)	D(m)	E(lx)
30°		
1.0	0.57	10564
2.0	1.13	2641
3.0	1.70	1174
4.0	2.26	660
5.0	2.83	422



Adjustable

2018.465-ACOT-73
2018.257A-ACOT-73

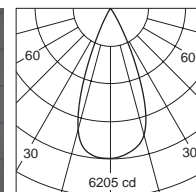
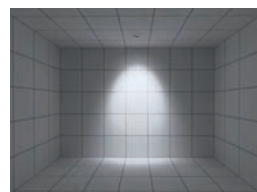

H(m)	D(m)	E(lx)
45°		
1.0	0.80	6180
2.0	1.59	1545
3.0	2.39	686
4.0	3.18	386
5.0	3.98	247



Adjustable

2018.465-ACOT-73
2018.257A-ACOT-73

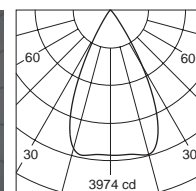
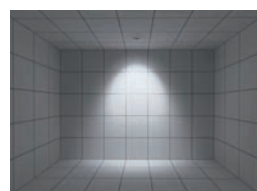

H(m)	D(m)	E(lx)
55°		
1.0	1.02	3740
2.0	2.04	935
3.0	3.06	415
4.0	4.09	233
5.0	5.11	149

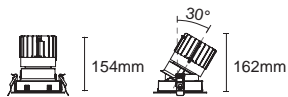

Cut out : 128x128mm (Trim)

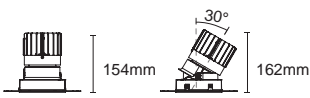

121mm



200mm

Cut out : 128x128mm (Trimless)

EPIC-135 Square-Wallwash



EPIC-135-STW
EPIC-135-STLW



Colours

Bezel: Black White

Baffle: Black

Article number	Fixture Consumption	Current	LED Lumen	Delivered Lumen	Beam Angle	CCT	CRI
Trim							
 2218.147-ACOT-73	32W	900 mA	3667 lm	-	Wallwash (Lens)	3000K	90+
2218.147-ACOT-73-WCW	29W	800 mA	2816-3190 lm	-	Wallwash (Lens)	2700K-6500K	90+
Trimless							
 2218.219A-ACOT-73	32W	900 mA	3667 lm	-	Wallwash (Lens)	3000K	90+
2218.219A-ACOT-73-WCW	29W	800 mA	2816-3190 lm	-	Wallwash (Lens)	2700K-6500K	90+

* Wallwash lens — best optical matching angle: 36°

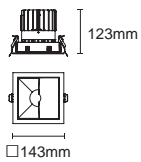

 Cut out : 128x128mm (Trim)

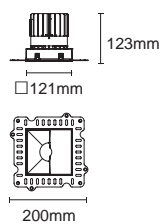

 Cut out : 128x128mm (Trimless)

Dimmable





EPIC-65

EPIC-85



ACOT-68



ACOT-69-WCW
Tunable White

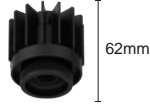

ACOT-70A
Narrow spot



ACOT-70



ACOT-70-WCW
Tunable White

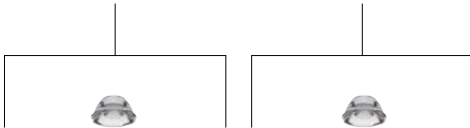

ACOT-74-15R
ACOT-74-36R
ACOT-74-50R

LN-004-15R
LN-004-36R
LN-004-50R



ACOT-75-10R

ACOT-75-15R
ACOT-75-36R
ACOT-75-50R

LN-008-15R
LN-008-36R
LN-008-50R



ACCL-3
Clear glass

ACSG-5
Striped glass

ACWG-6
Woven glass



ACCL-4
Clear glass

ACSG-4
Striped glass

ACWG-5
Woven glass



ACDS-3
Diffusion sheet



ACHO-6
Honeycomb louver



ACDS-4
Diffusion sheet



ACHO-5
Honeycomb louver

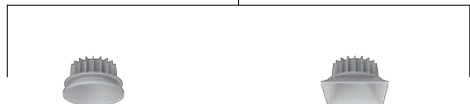

ACOT-44D

ACOT-46D



ACOT-50D

ACOT-52D



ACOT-45D

ACOT-47D



ACOT-51D

ACOT-53D

ACOT-71A
engine is not
suitable with
wallwash baffles



ACOT-54



ACOT-55

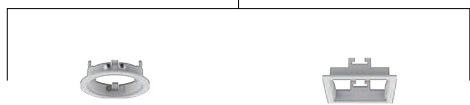

RT-EP65-1

ST-EP65-1



RT-EP85-1

ST-EP85-1



RTL-EP65-1

STL-EP65-1



RTL-EP85-1

STL-EP85-1

EPIC-110

EPIC-135

Light engine



Lens

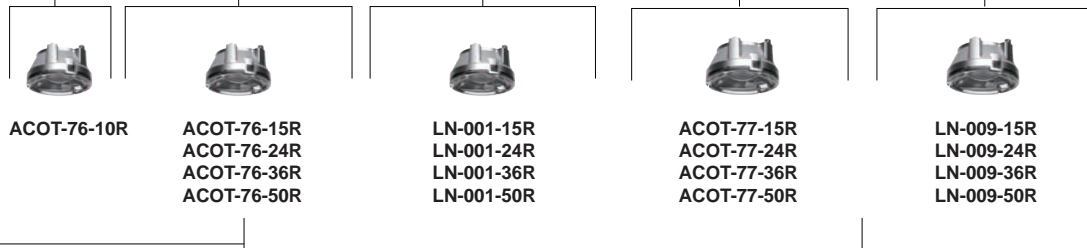

Accessories

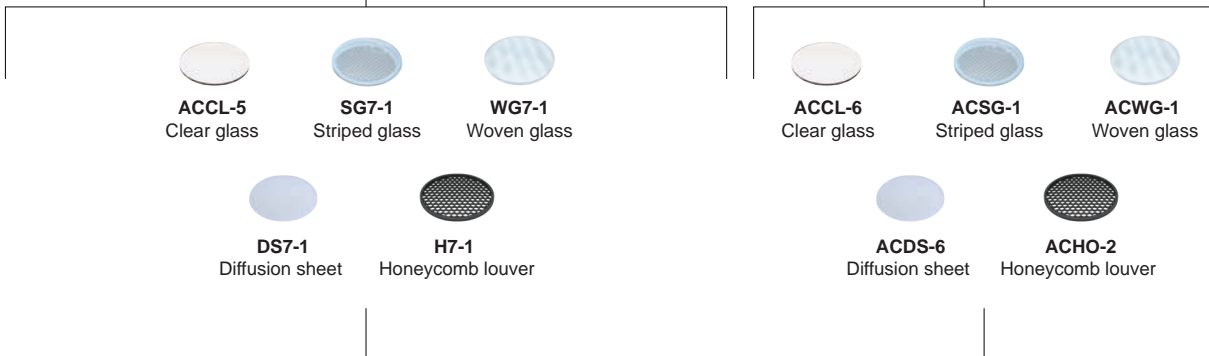

Baffle

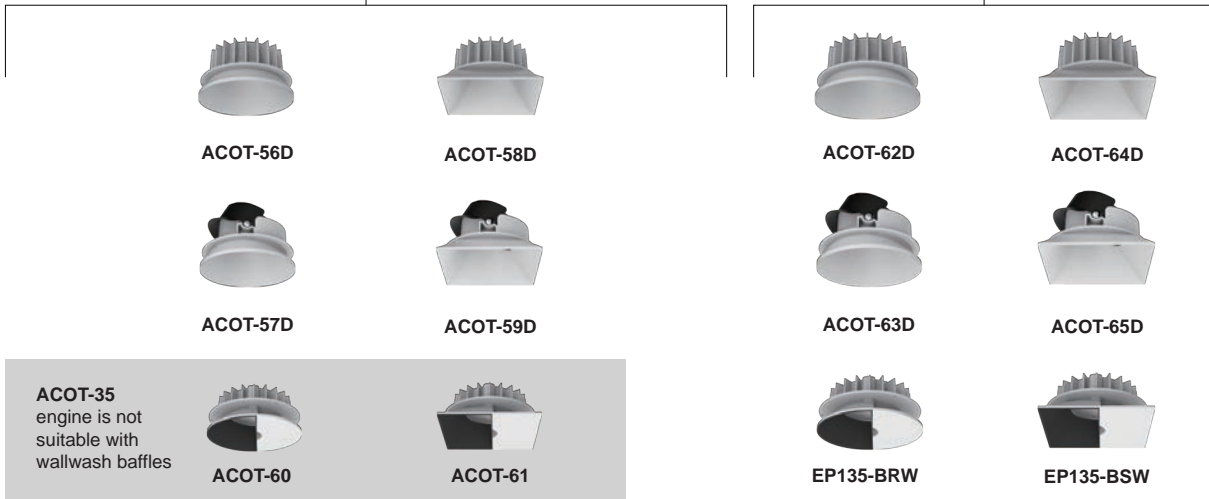

Trim

