

# MARS SERIES (EU)

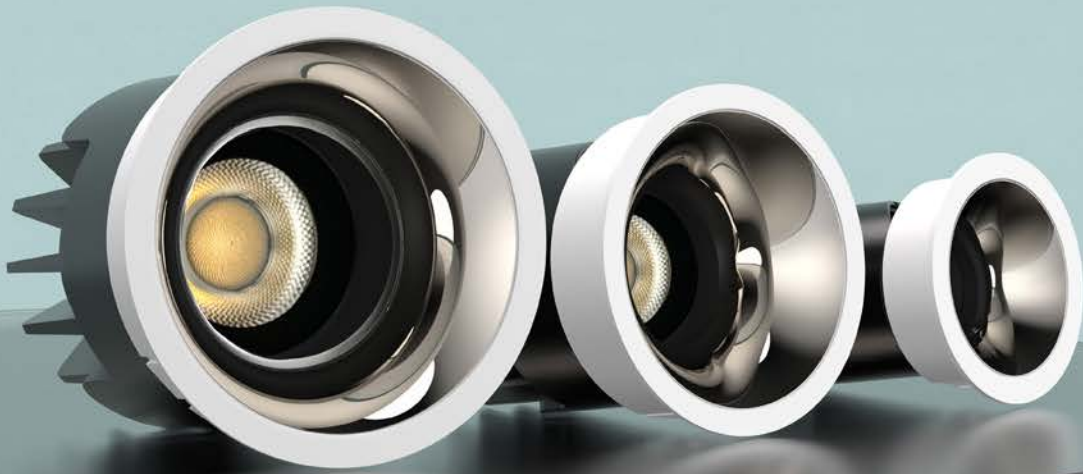

# MARS (EU)

The MARS Series brings together innovative engineering and sleek aesthetics. Its exclusive quick-release heat sink allows seamless switching between fixed and tilting modes — one twist is all it takes for installation or maintenance.

Built-in angle scale enables 355° rotation and 35° tilting, offering precise and versatile light control. The detachable baffle pulls down easily and locks in place with a simple twist — no tools required. Combined with a spherical baffle design, it ensures zero light leakage at any angle.

Available in multiple sizes, the MARS Series adapts to every space — from focused accent lighting to expansive commercial applications.

Ø55



Ø75



Ø95



## Modular light engine

The MARS series features a modular light engine design, integrating the light source, optics, and driver into a replaceable unit. This allows users to easily swap beam angles, wattages, or color temperatures without altering the fixture housing.

This modular approach not only streamlines installation and maintenance, but also extends the product's lifecycle—offering greater flexibility and efficiency across different lighting applications.



## Seamless transition between fixed and tilting

Clear visual indicators guide users to switch intuitively between fixed and tilting modes — no tools required, making installation and adjustment quick and easy.

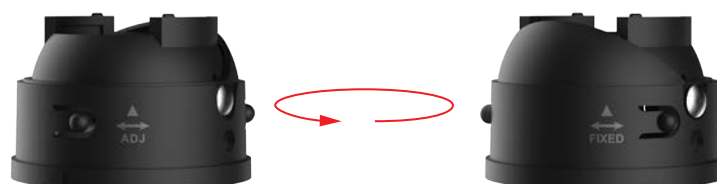

# Visual Comfort with Low Glare

Designed with a 40° cut-off angle, the fixture effectively blocks excess light and prevents direct glare into the eyes. It delivers focused yet soft illumination, making it ideal for environments where visual comfort is essential—such as retail displays, reception areas, and high-end residential spaces.

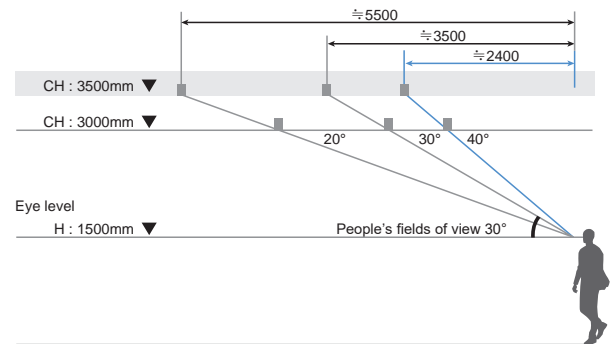
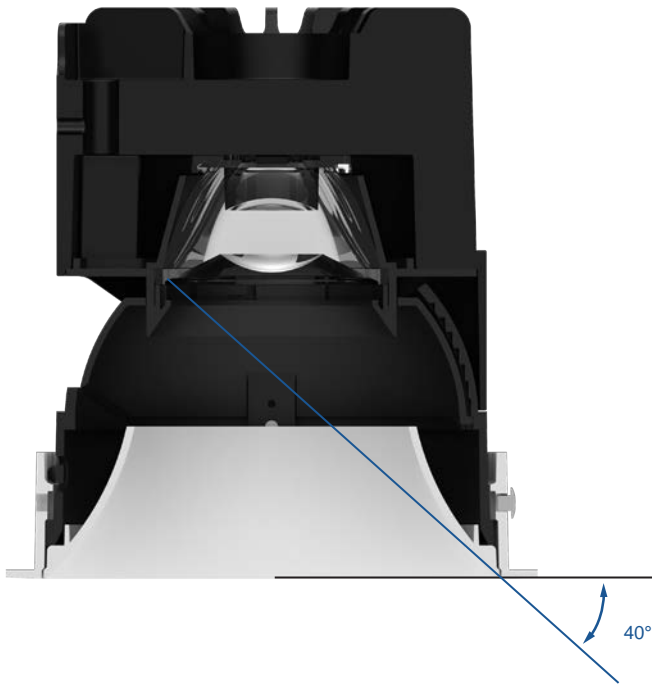

Bigger the cut-off angle, the more the visible glare is reduced

## Freedom to rotate and tilt

355° rotation and 35° tilting angle to meet diverse lighting needs.

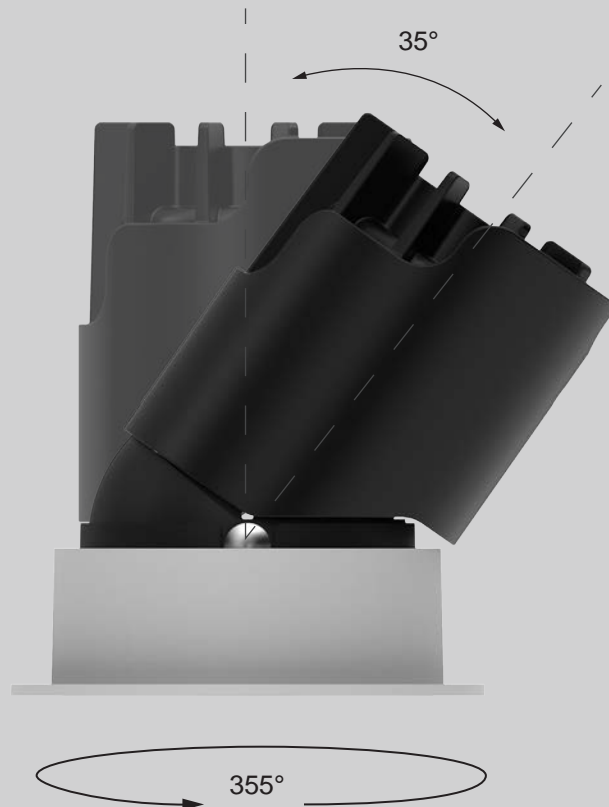

## Slim Bezel

The MARS series features a slim bezel design that minimizes visual edges for a cleaner, more refined ceiling appearance. The frame subtly blends into the architecture, enhancing the sense of space while drawing attention to the purity and quality of the light. It's not just a design choice—it's a seamless extension of modern spatial aesthetics.

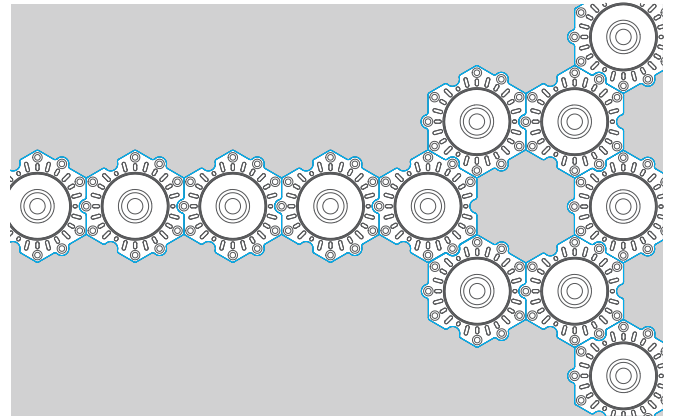
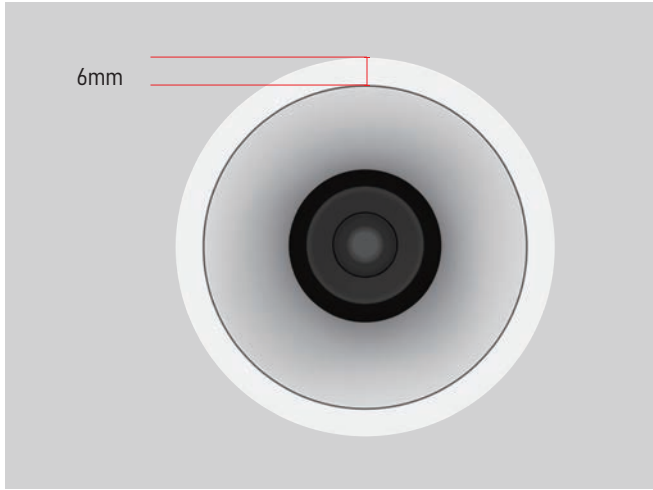

## Seamless Trimless

Featuring a modular trimless design, the fixture installs flush with the ceiling, creating a clean and seamless visual finish with no visible edges. When arranged in multiples, fixtures can be easily aligned in a linear configuration, delivering a continuous rhythm of light that enhances spatial coherence.

Whether used as a single spotlight or in a linear row, the trimless structure integrates effortlessly into architectural ceilings, offering a minimalist, modern, and highly consistent lighting aesthetic.

## Precision scale guidance

Internal degree markings enable professional-level accuracy for targeted lighting adjustments.

- 35°
- 30°
- 25°
- 20°
- 15°
- 10°
- 5°
- 0°



## Spherical baffle design

Adjust freely with seamless light control for precision illumination.

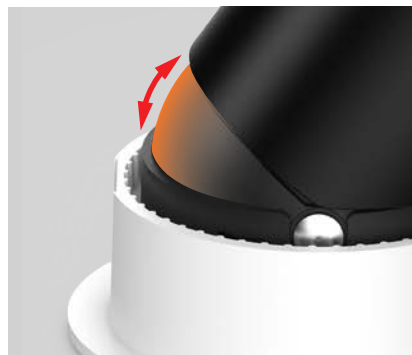
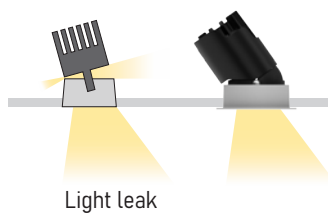

## Quick-release baffle

Pull down to remove, snap on and twist lightly to lock — easy installation and maintenance.

# Baffle Color Options

Tailored Aesthetics, Enhanced Light Quality



White



Piano black



Chrome



Gun metal-black

# Flexible Optical Accessories

This fixture supports a range of interchangeable optical accessories to meet diverse lighting needs

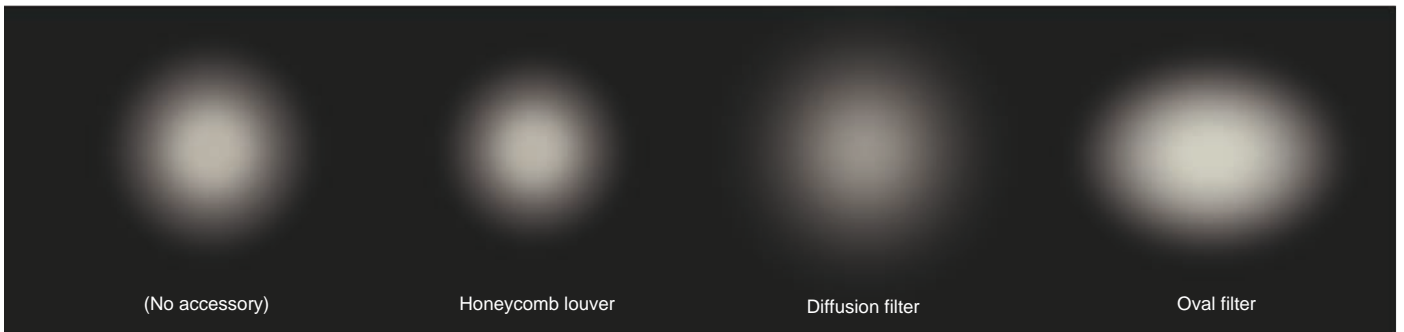
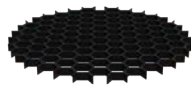

# Intuitive Removal Design Tool-Free, Effortless Access

After removing the reflector, the pull-ring mechanism becomes visible. No tools are required — simply pull down to release the module for quick maintenance or replacement. It's a thoughtful feature that simplifies installation and enhances the user experience, reflecting the MARS series' commitment to both form and function.



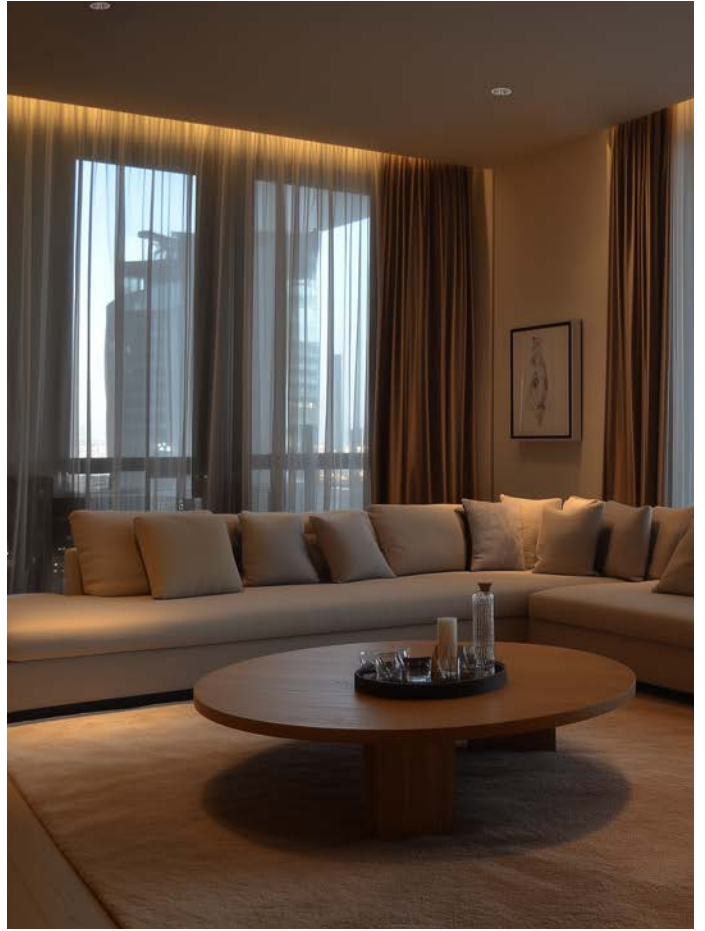



# MARS-55 Round-Fixed/Adjustable



## Colours

Bezel : Black  White

Baffle : Piano black  White  Chrome  Gun metal-black

Article number	LED / Fixture Consumption	Current	LED / Delivered Lumen	Beam Angle	CCT	CRI
----------------	---------------------------	---------	-----------------------	------------	-----	-----

### Trim

MA55-RTA-LEE-29D-HE	7W / 8W	200 mA	806 lm / 553 lm	15°/24°/36° (Lens)	3000K	90+
---------------------	---------	--------	-----------------	--------------------	-------	-----

### Trimless

MA55-RTLA-LEE-29D-HE	7W / 8W	200 mA	806 lm / 553 lm	15°/24°/36° (Lens)	3000K	90+
----------------------	---------	--------	-----------------	--------------------	-------	-----



### Trim

MA55-RTA-LEE-29D	7W / 8W	200 mA	794 lm / 516 lm	15°/24°/36° (Lens)	3000K	90+
------------------	---------	--------	-----------------	--------------------	-------	-----

### Trimless

MA55-RTLA-LEE-29D	7W / 8W	200 mA	794 lm / 516 lm	15°/24°/36° (Lens)	3000K	90+
-------------------	---------	--------	-----------------	--------------------	-------	-----

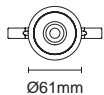

Cut out : 55mm

## Dimmable

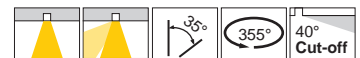

## Optional Accessory



H-011 Honeycomb louver

SG-015 Oval filter

DS-012 Diffusion filter

 **15°**

Fixed/Adjustable UGR<10

MA55-RTA-LEE-29D-HE  
MA55-RTLA-LEE-29D-HE

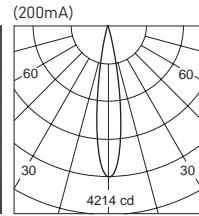
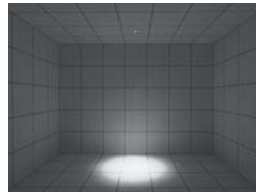

H(m)	D(m)	E(lx)
<b>15°</b>		
1.0	0.30	2942
2.0	0.60	735
3.0	0.90	326
4.0	1.20	183
5.0	1.5	117

 **24°**

Fixed/Adjustable UGR<10

MA55-RTA-LEE-29D-HE  
MA55-RTLA-LEE-29D-HE

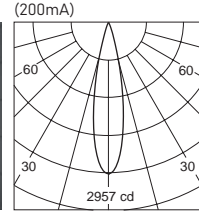
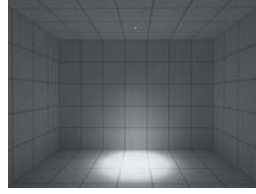

H(m)	D(m)	E(lx)
<b>24°</b>		
1.0	0.38	2084
2.0	0.77	521
3.0	1.15	231
4.0	1.54	130
5.0	1.92	83

 **36°**

Fixed/Adjustable UGR<10

MA55-RTA-LEE-29D-HE  
MA55-RTLA-LEE-29D-HE

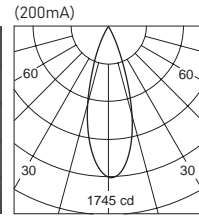
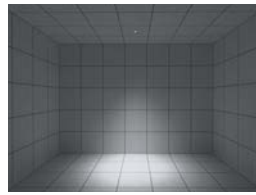

H(m)	D(m)	E(lx)
<b>36°</b>		
1.0	0.58	1167
2.0	1.17	291
3.0	1.75	129
4.0	2.33	72
5.0	2.92	46

# MARS-75 Round-Fixed/Adjustable



## Colours

Bezel : Black  White

Baffle : Piano black  White  Chrome  Gun metal-black

Article number	LED / Fixture Consumption	Current	LED / Delivered Lumen	Beam Angle	CCT	CRI
Trim						
MA75-RTA-LEE-30D-HE	12W / 15W	350 mA	1811 lm / 1182 lm	25°/30°/36°/50° (Lens)	3000K	90+

Trimless						
MA75-RTLA-LEE-30D-HE	12W / 15W	350 mA	1811 lm / 1182 lm	25°/30°/36°/50° (Lens)	3000K	90+



Trim						
MA75-RTA-LEE-30D	12W / 15W	350 mA	1454 lm / 974 lm	25°/30°/36°/50° (Lens)	3000K	90+

Trimless						
MA75-RTLA-LEE-30D	12W / 15W	350 mA	1454 lm / 974 lm	25°/30°/36°/50° (Lens)	3000K	90+

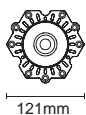

Cut out : 75mm

## Dimmable



## Optional Accessory



H-012  
Honeycomb louver

SG-016  
Oval filter

DS-013  
Diffusion filter

 **25°**

Fixed/Adjustable UGR<10

MA75-RTA-LEE-30D-HE  
MA75-RTLA-LEE-30D-HE

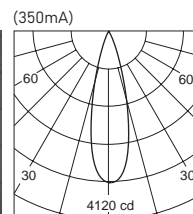
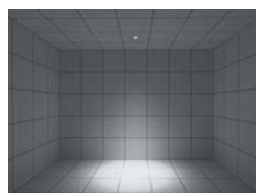

H(m)	D(m)	E(lx)
<b>25°</b>		
1.0	0.48	2865
2.0	0.95	716
3.0	1.43	318
4.0	1.91	179
5.0	2.38	114

 **30°**

Fixed/Adjustable UGR<10

MA75-RTA-LEE-30D-HE  
MA75-RTLA-LEE-30D-HE

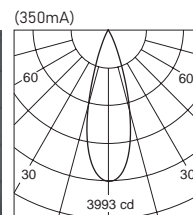
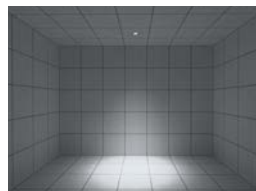

H(m)	D(m)	E(lx)
<b>30°</b>		
1.0	0.55	2754
2.0	1.10	688
3.0	1.65	306
4.0	2.20	172
5.0	2.75	110

 **36°**

Fixed/Adjustable UGR<10

MA75-RTA-LEE-30D-HE  
MA75-RTLA-LEE-30D-HE

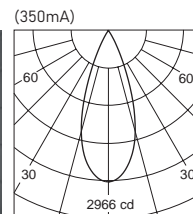
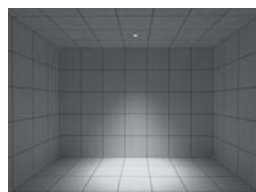

H(m)	D(m)	E(lx)
<b>36°</b>		
1.0	0.69	2047
2.0	1.38	511
3.0	2.06	227
4.0	2.75	127
5.0	3.44	81

 **50°**

Fixed/Adjustable UGR<16

MA75-RTA-LEE-30D-HE  
MA75-RTLA-LEE-30D-HE

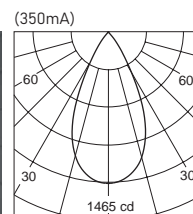
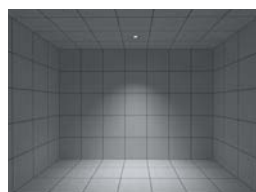

H(m)	D(m)	E(lx)
<b>50°</b>		
1.0	0.94	934
2.0	1.87	233
3.0	2.81	103
4.0	3.75	58
5.0	4.69	37

# MARS-95 Round-Fixed/Adjustable



## Colours

Bezel : Black  White

Baffle : Piano black  White  Chrome  Gun metal-black

Article number	LED / Fixture Consumption	Current	LED / Delivered Lumen	Beam Angle	CCT	CRI
----------------	---------------------------	---------	-----------------------	------------	-----	-----

### Trim

MA95-RTA-LEE-31D-HE	18W / 20W	500 mA	2504 lm / 2044 lm	20°/25°/36°/45° (Lens)	3000K	90+
---------------------	-----------	--------	-------------------	------------------------	-------	-----

### Trimless

MA95-RTLA-LEE-31D-HE	18W / 20W	500 mA	2504 lm / 2044 lm	20°/25°/36°/45° (Lens)	3000K	90+
----------------------	-----------	--------	-------------------	------------------------	-------	-----



### Trim

MA95-RTA-LEE-31D	18W / 20W	500 mA	2004 lm / 1663 lm	20°/25°/36°/45° (Lens)	3000K	90+
------------------	-----------	--------	-------------------	------------------------	-------	-----

### Trimless

MA95-RTLA-LEE-31D	18W / 20W	500 mA	2004 lm / 1663 lm	20°/25°/36°/45° (Lens)	3000K	90+
-------------------	-----------	--------	-------------------	------------------------	-------	-----

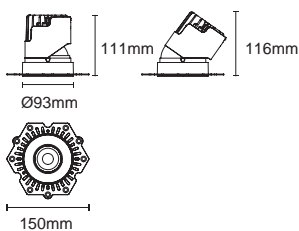
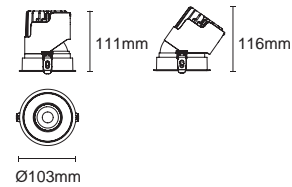

Cut out : 95mm

## Dimmable



## Optional Accessory



H-013  
Honeycomb louver

SG-017  
Oval filter

DS-014  
Diffusion filter

 **20°**

Fixed/Adjustable UGR<10

MA95-RTA-LEE-31D-HE  
MA95-RTLA-LEE-31D-HE

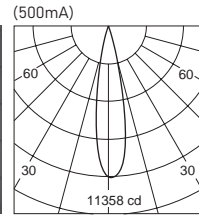
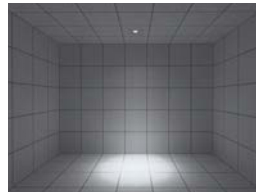

H(m)	D(m)	E(lx)
20°		
1.0	0.36	7837
2.0	0.72	1959
3.0	1.08	870
4.0	1.44	489
5.0	1.79	313

 **25°**

Fixed/Adjustable UGR<10

MA95-RTA-LEE-31D-HE  
MA95-RTLA-LEE-31D-HE

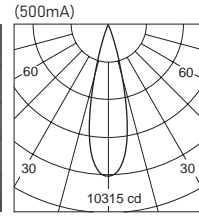
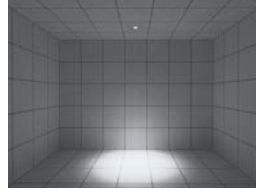

H(m)	D(m)	E(lx)
25°		
1.0	0.46	7158
2.0	0.93	1789
3.0	1.39	795
4.0	1.85	447
5.0	2.32	286

 **36°**

Fixed/Adjustable UGR<10

MA95-RTA-LEE-31D-HE  
MA95-RTLA-LEE-31D-HE

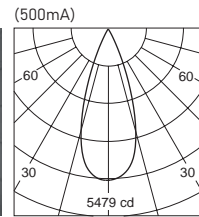
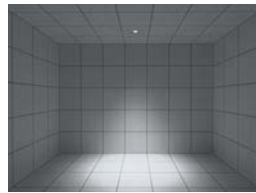

H(m)	D(m)	E(lx)
36°		
1.0	0.67	3838
2.0	1.34	959
3.0	2.02	426
4.0	2.69	239
5.0	3.36	153

 **45°**

Fixed/Adjustable UGR<10

MA95-RTA-LEE-31D-HE  
MA95-RTLA-LEE-31D-HE

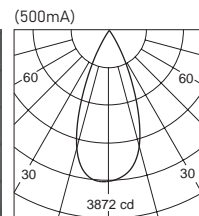
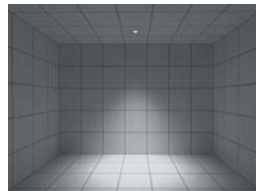

H(m)	D(m)	E(lx)
45°		
1.0	0.78	2641
2.0	1.56	660
3.0	2.34	293
4.0	3.12	165
5.0	3.91	105